



Ermis®



Hauptkatalog
General Catalogue

**Skalpellklingen, Skalpellgriffe, Messer
Scalpel Blades, Scalpel Handles, Knives
Hojas de bisturíes, Mangos de bisturíes, Cuchillos
Lame per bisturi, Manici per bisturi, Coltelli**



Sterile Skalpellslingen, Skalpellsgriffe
Sterile Scalpel Blades, Scalpel Handles
Hojas de bisturías estériles, Mangos de bisturías
Lame per bisturi sterili, Manici per bisturi



No. 3
13,0 cm, 5"
10-1003-00



No. 3
13,0 cm, 5"
10-1003-01



No. 3L
21,0 cm, 8¼"
10-1003-02



No. 7
16,5 cm, 6½"
10-1007-00



No. 7K
13,0 cm, 5"
10-1007-01

Sterile Skalpellslingen, Skalpellsgriffe
Sterile Scalpel Blades, Scalpel Handles
Hojas de bisturíes estériles, Mangos de bisturíes
Lame per bisturi sterili, Manici per bisturi



No. 4
13,5 cm, 5³/₈"
10-1004-00



No. 4L
21,0 cm, 8³/₈"
10-1004-01



No. 8
13,5 cm, 5³/₈"
10-1008-00



No. 9
14,5 cm, 5³/₄"
10-1009-00

Einmal-Skalpelle, steril
Disposable Scalpels, sterile
Bisturíes para uso único, estériles
Bisturi monouso, sterili



Fig. 10
10-1050-10



Fig. 11
10-1050-11



Fig. 11s
10-1050-11S



Fig. 12
10-1050-12



Fig. 12d
10-1050-12D



Fig. 13
10-1050-13



Fig. 15
10-1050-15



Fig. 15c
10-1050-15C

Einmal-Skalpelle, steril
Disposable Scalpels, sterile
Bisturíes para uso único, estériles
Bisturi monouso, sterili



Fig. 18
10-1050-18



Fig. 19
10-1050-19



Fig. 20
10-1050-20



Fig. 21
10-1050-21



Fig. 22
10-1050-22



Fig. 23
10-1050-23



Fig. 24
10-1050-24



Fig. 25
10-1050-25

Skalpelle
Knives
Bisturíes
Bisturi



OPERATION
17,0 cm, 6¾"



Fig. 10 **10-1060-10**
Fig. 12 **10-1060-12**
Fig. 14 **10-1060-14**
Fig. 16 **10-1060-16**
Fig. 18 **10-1060-18**



COLLIN
16,0 cm, 6¼"



Fig. 4 **10-1066-04**
Fig. 5 **10-1066-05**
Fig. 6 **10-1066-06**



Fig. 1 **10-1066-01**
Fig. 2 **10-1066-02**
Fig. 3 **10-1066-03**



Fig. 1 **10-1070-01**
Fig. 2 **10-1070-02**
Fig. 3 **10-1070-03**
Fig. 4 **10-1070-04**
Fig. 5 **10-1070-05**



Fig. 1 **10-1076-01**
Fig. 2 **10-1076-02**
Fig. 3 **10-1076-03**
Fig. 4 **10-1076-04**
Fig. 5 **10-1076-05**



Fig. 15 **10-1078-15**



Fig. 6 **10-1070-06**
Fig. 7 **10-1070-07**
Fig. 8 **10-1070-08**
Fig. 9 **10-1070-09**
Fig. 10 **10-1070-10**



Fig. 6 **10-1076-06**
Fig. 7 **10-1076-07**
Fig. 8 **10-1076-08**
Fig. 9 **10-1076-09**

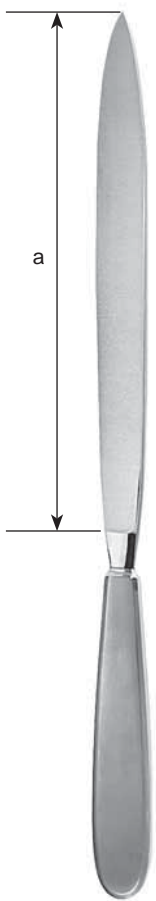

Fig. 16 **10-1078-16**

DISSECTING
17,0 cm, 6¾"

DIEFENBACH
16,0 cm, 6¼"

Amputationsmesser
 Amputation Knives
 Cuchillos para amputación
 Coltelli per amputazione



COLLIN

a	
13,0 cm, 5"	10-1080-13
16,0 cm, 6 ¹ / ₄ "	10-1080-16
19,0 cm, 7 ¹ / ₂ "	10-1080-19
22,0 cm, 8 ⁵ / ₈ "	10-1080-22
28,0 cm, 11"	10-1080-28

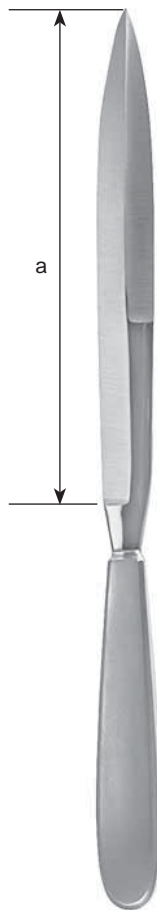

CATLIN

A	
16,0 cm, 6 ¹ / ₄ "	10-1082-16
19,0 cm, 7 ¹ / ₂ "	10-1082-19
22,0 cm, 8 ⁵ / ₈ "	10-1082-22

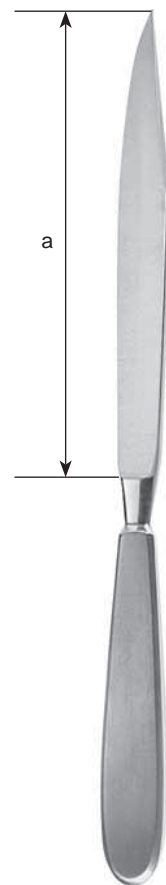

LISTON

A	
17,0 cm, 6 ³ / ₄ "	10-1250-17
20,0 cm, 8"	10-1250-20
22,0 cm, 8 ⁵ / ₈ "	10-1250-22

Amputationsmesser, Messer für Autopsie
 Amputation Knives, Post Mortem Knives
 Cuchillos para amputación, Cuchillos para autopsia
 Coltelli per amputazione, Coltelli per autopsia

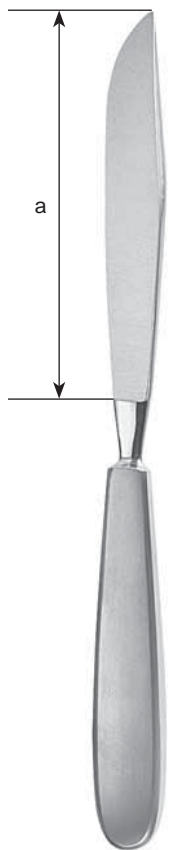

LANGENBECK
 10-1280-12

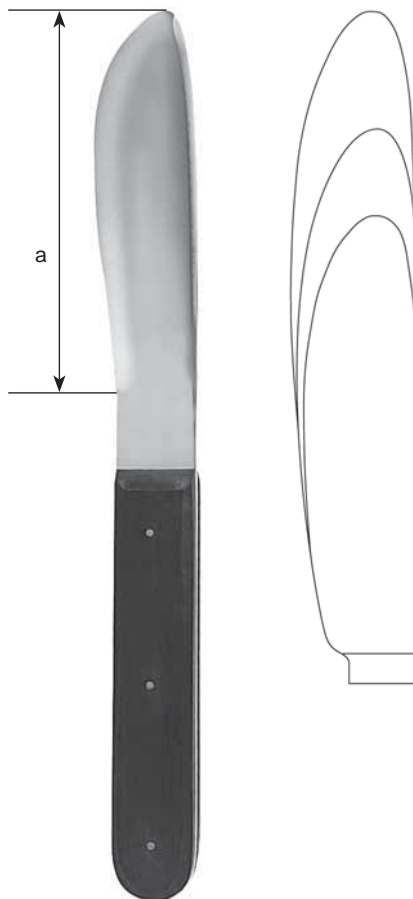

WALB

A	
11,0 cm, 4 1/2"	10-1150-11
14,0 cm, 5 1/2"	10-1150-14
17,0 cm, 6 3/4"	10-1150-17

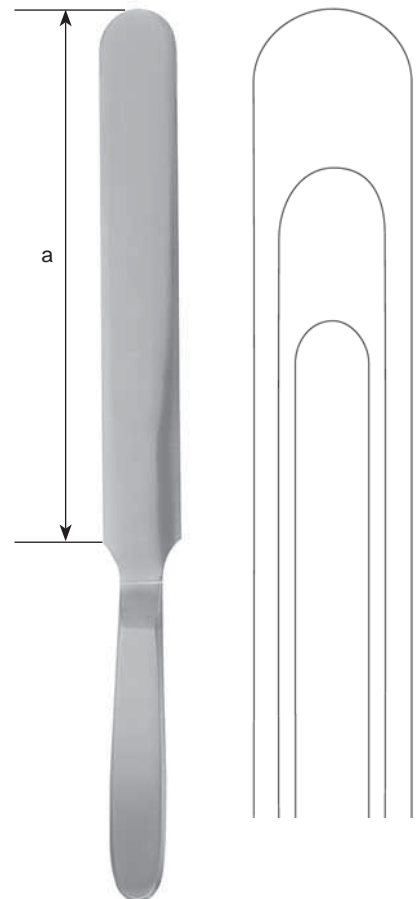

VIRCHOW

A	
16,0 cm, 6 1/4"	10-1180-16
20,0 cm, 8"	10-1180-20
24,0 cm, 9 1/2"	10-1180-24

Amputationsmesser, Dermatomye
Amputation Knives, Dermatomyes
Cuchillos para amputación, Dermátomos
Coltelli per amputazione, Dermatomyi



LANGENBECK
18,0 cm, 7"
10-1105-55



mit Schaber
with raspatory
con periostótomo
con raschiatoio

CARTILAGE
17,5 cm, 6⁵/₈"
10-1110-65



Haut-Spannplatten
Skin straightening plate
Placa para extender la piel
Placca per stendere la pelle

10-1422-30

**Resektionsmesser
Resection Knives
Cuchillos para resección
Coltelli per resezione**

10-1401-19
Ersatzklinge
Spare blade
Hoja de repuesto
Lama di ricambio



SILVER
19 cm, 7 1/2"
10-1400-19

10-1411-30
Ersatzklinge
Spare blade
Hoja de repuesto
Lama di ricambio



BRAITHWAITE
30,0 cm, 12"
10-1410-30

10-1413-35
Ersatzklinge
Spare blade
Hoja de repuesto
Lama di ricambio



HUMBY
35,0 cm, 14"
10-1412-35

10-1421-30
Ersatzklinge
Spare blade
Hoja de repuesto
Lama di ricambio



SCHINK
30,0 cm, 12"
10-1420-30

Scheren
Scissors
Tijeras
Forbici



Chirurgische Scheren
 Surgical Scissors
 Tijeras para cirugía
 Forbici per chirurgia



STANDARD	
10,5 cm, 4 ¹ / ₄ "	11-1000-10
11,5 cm, 4 ¹ / ₂ "	11-1000-11
13,0 cm, 5"	11-1000-13
14,5 cm, 5 ³ / ₄ "	11-1000-14
15,5 cm, 6"	11-1000-15
16,5 cm, 6 ¹ / ₂ "	11-1000-16
17,5 cm, 6 ⁵ / ₈ "	11-1000-17
18,5 cm, 7 ¹ / ₄ "	11-1000-18
20,0 cm, 8"	11-1000-20

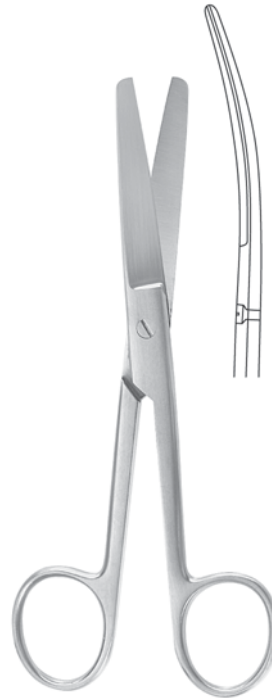

STANDARD	
10,5 cm, 4 ¹ / ₄ "	11-1001-10
11,5 cm, 4 ¹ / ₂ "	11-1001-11
13,0 cm, 5"	11-1001-13
14,5 cm, 5 ³ / ₄ "	11-1001-14
15,5 cm, 6"	11-1001-15
16,5 cm, 6 ¹ / ₂ "	11-1001-16
17,5 cm, 6 ⁵ / ₈ "	11-1001-17
18,5 cm, 7 ¹ / ₄ "	11-1001-18
20,0 cm, 8"	11-1001-20



STANDARD	
10,5 cm, 4 ¹ / ₄ "	11-1002-10
11,5 cm, 4 ¹ / ₂ "	11-1002-11
13,0 cm, 5"	11-1002-13
14,5 cm, 5 ³ / ₄ "	11-1002-14
15,5 cm, 6"	11-1002-15
16,5 cm, 6 ¹ / ₂ "	11-1002-16
17,5 cm, 6 ⁵ / ₈ "	11-1002-17
18,5 cm, 7 ¹ / ₄ "	11-1002-18
20,0 cm, 8"	11-1002-20

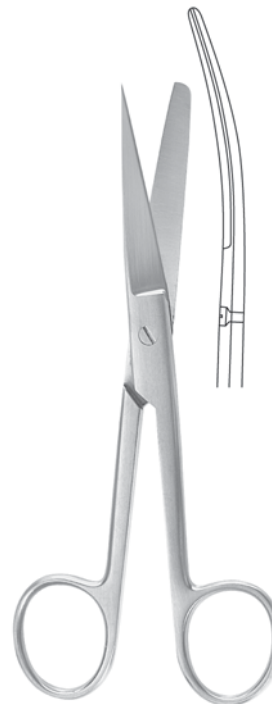

STANDARD	
10,5 cm, 4 ¹ / ₄ "	11-1003-10
11,5 cm, 4 ¹ / ₂ "	11-1003-11
13,0 cm, 5"	11-1003-13
14,5 cm, 5 ³ / ₄ "	11-1003-14
15,5 cm, 6"	11-1003-15
16,5 cm, 6 ¹ / ₂ "	11-1003-16
17,5 cm, 6 ⁵ / ₈ "	11-1003-17
18,5 cm, 7 ¹ / ₄ "	11-1003-18
20,0 cm, 8"	11-1003-20

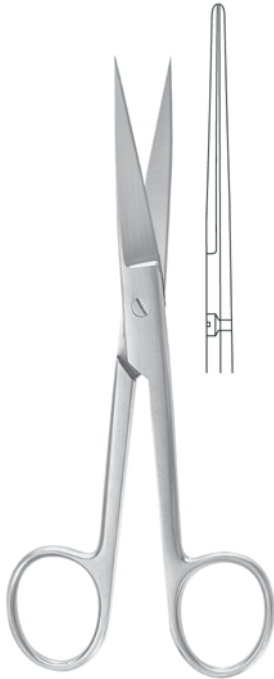

STANDARD	
10,5 cm, 4 ¹ / ₄ "	11-1004-10
11,5 cm, 4 ¹ / ₂ "	11-1004-11
13,0 cm, 5"	11-1004-13
14,5 cm, 5 ³ / ₄ "	11-1004-14
15,5 cm, 6"	11-1004-15
16,5 cm, 6 ¹ / ₂ "	11-1004-16
17,5 cm, 6 ⁵ / ₈ "	11-1004-17
18,5 cm, 7 ¹ / ₄ "	11-1004-18
20,0 cm, 8"	11-1004-20



STANDARD	
10,5 cm, 4 ¹ / ₄ "	11-1005-10
11,5 cm, 4 ¹ / ₂ "	11-1005-11
13,0 cm, 5"	11-1005-13
14,5 cm, 5 ³ / ₄ "	11-1005-14
15,5 cm, 6"	11-1005-15
16,5 cm, 6 ¹ / ₂ "	11-1005-16
17,5 cm, 6 ⁵ / ₈ "	11-1005-17
18,5 cm, 7 ¹ / ₄ "	11-1005-18
20,0 cm, 8"	11-1005-20

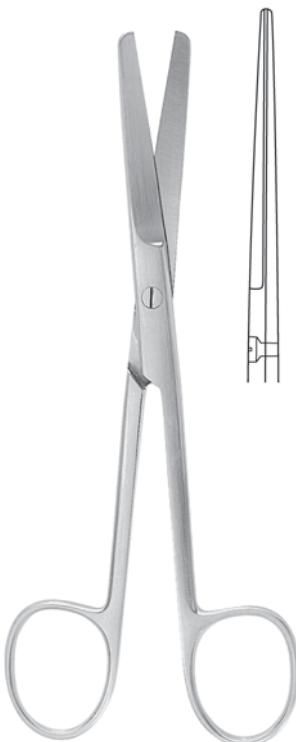

DEAVER	
12,0 cm, 4 ³ / ₄ "	11-1050-12
13,0 cm, 5"	11-1050-13
14,5 cm, 5 ³ / ₄ "	11-1050-14



DEAVER	
12,0 cm, 4 ³ / ₄ "	11-1051-12
13,0 cm, 5"	11-1051-13
14,5 cm, 5 ³ / ₄ "	11-1051-14

Präparierscheren
Dissecting Scissors
Tijeras de disección
Forbici per dissezione



DEAVER

12,0 cm, 4 ³ / ₄ "	11-1052-12
13,0 cm, 5"	11-1052-13
14,5 cm, 5 ³ / ₄ "	11-1052-14

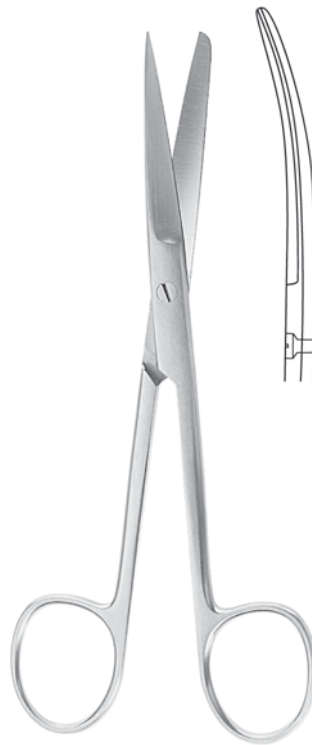

DEAVER

12,0 cm, 4 ³ / ₄ "	11-1053-12
13,0 cm, 5"	11-1053-13
14,5 cm, 5 ³ / ₄ "	11-1053-14



DEAVER

12,0 cm, 4 ³ / ₄ "	11-1054-12
13,0 cm, 5"	11-1054-13
14,5 cm, 5 ³ / ₄ "	11-1054-14



DEAVER

12,0 cm, 4 ³ / ₄ "	11-1055-12
13,0 cm, 5"	11-1055-13
14,5 cm, 5 ³ / ₄ "	11-1055-14



GRAZIL
 13,0 cm, 5" **11-1070-13**
 14,5 cm, 5³/₄" **11-1070-14**



GRAZIL
 13,0 cm, 5" **11-1071-13**
 14,5 cm, 5³/₄" **11-1071-14**



GRAZIL
 13,0 cm, 5" **11-1072-13**
 14,5 cm, 5³/₄" **11-1072-14**



GRAZIL
 13,0 cm, 5" **11-1073-13**
 14,5 cm, 5³/₄" **11-1073-14**

Präparierscheren
Dissecting Scissors
Tijeras de disección
Forbici per dissezione



GRAZIL
 13,0 cm, 5" **11-1074-13**
 14,5 cm, 5³/₄" **11-1074-14**



GRAZIL
 13,0 cm, 5" **11-1075-13**
 14,5 cm, 5³/₄" **11-1075-14**

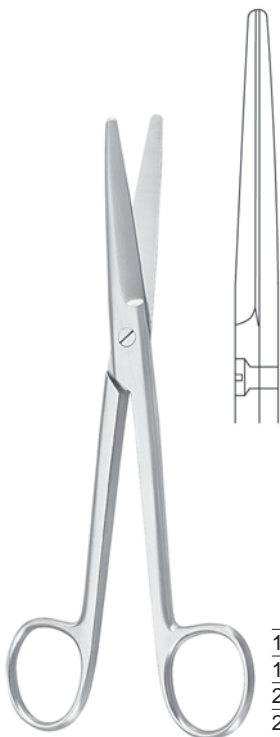

MAYO
 14,5 cm, 5³/₄" **11-1100-14**
 17,0 cm, 6³/₄" **11-1100-17**
 23,0 cm, 9" **11-1100-23**
 28,0 cm, 11" **11-1100-28**

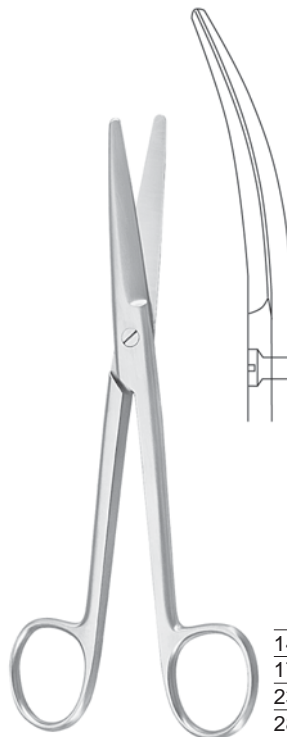

MAYO
 14,5 cm, 5³/₄" **11-1101-14**
 17,0 cm, 6³/₄" **11-1101-17**
 23,0 cm, 9" **11-1101-23**
 28,0 cm, 11" **11-1101-28**

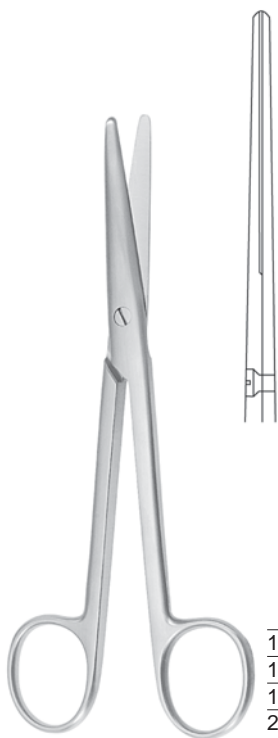

MAYO-STILE

15,0 cm, 6"	11-1102-15
17,0 cm, 6 ³ / ₄ "	11-1102-17
19,5 cm, 7 ³ / ₄ "	11-1102-19
21,0 cm, 8 ¹ / ₄ "	11-1102-21

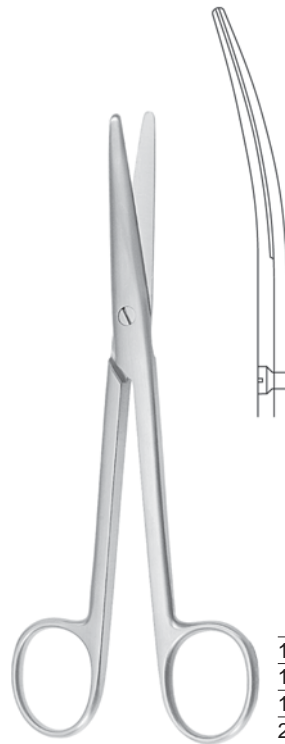

MAYO-STILE

15,0 cm, 6"	11-1103-15
17,0 cm, 6 ³ / ₄ "	11-1103-17
19,5 cm, 7 ³ / ₄ "	11-1103-19
21,0 cm, 8 ¹ / ₄ "	11-1103-21



11-1104-17



11-1105-17

MAYO-NOBLE
 17,0 cm, 6³/₄"



FOMON

13,5 cm, 5 ³ / ₈ "	11-1009-13
--	------------

Präparierscheren
Dissecting Scissors
Tijeras de disección
Forbici per dissezione



BABY-METZENBAUM
 11,5 cm, 4¹/₂"



11-1110-11



11-1111-11



METZENBAUM
 14,5 cm, 5³/₄"



11-1110-14

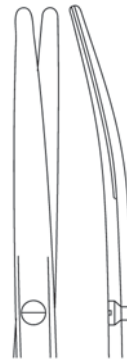

11-1111-14



METZENBAUM
 14,5 cm, 5³/₄"



11-1113-14



METZENBAUM
 14,5 cm, 5³/₄"



11-1115-14

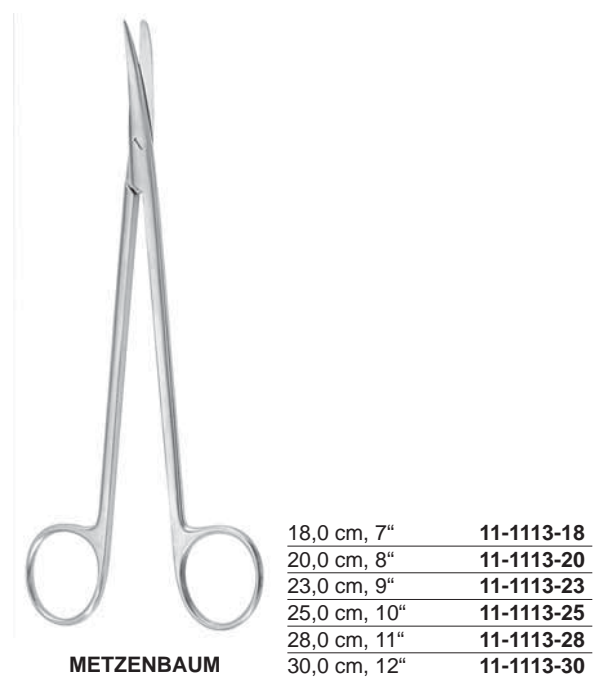
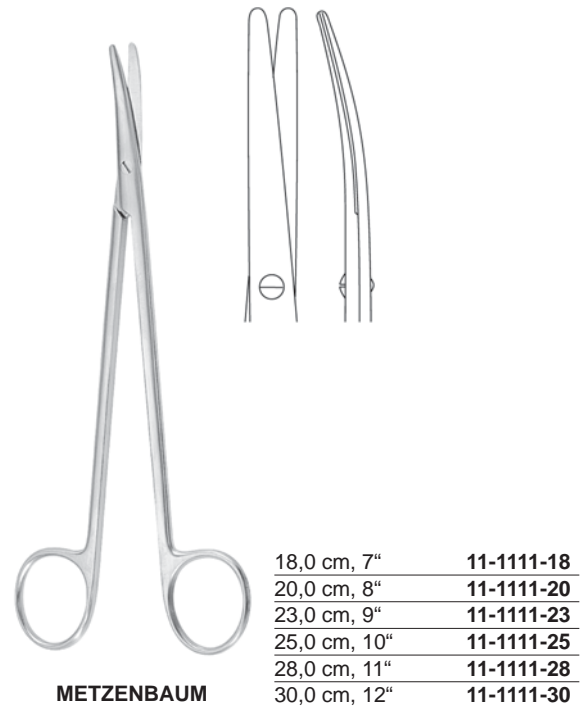
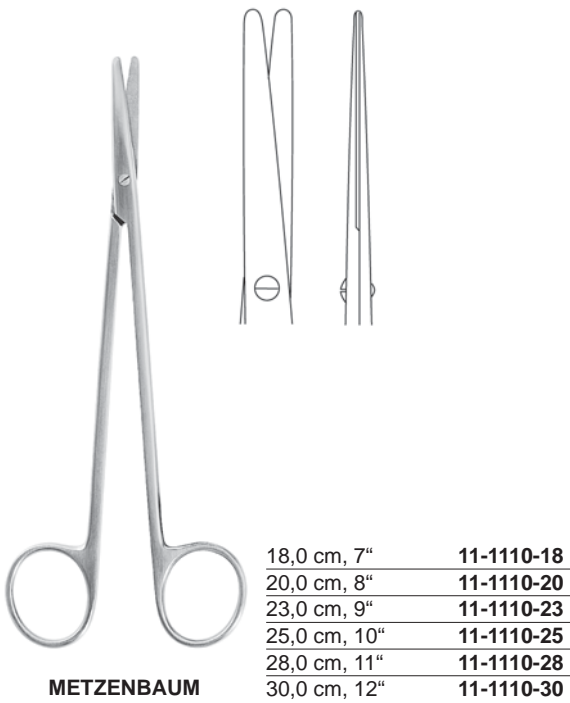

Präparierscheren
Dissecting Scissors
Tijeras de disección
Forbici per dissezione

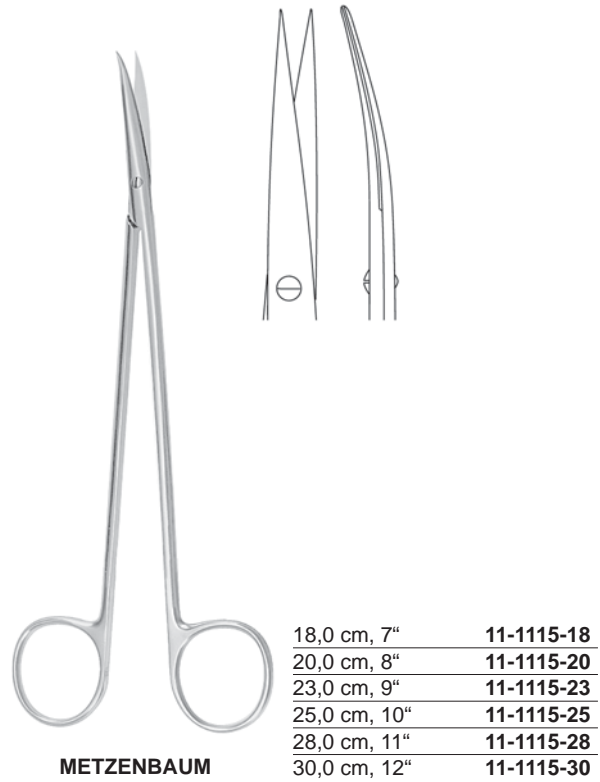
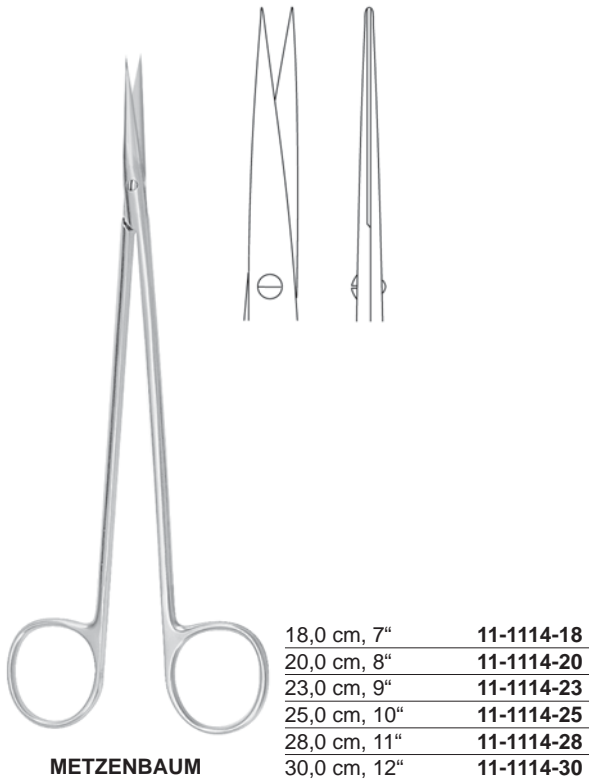

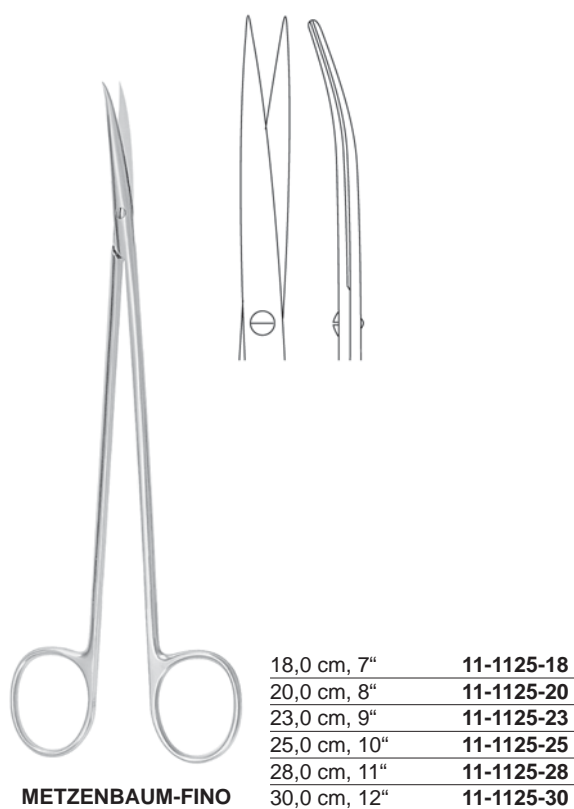
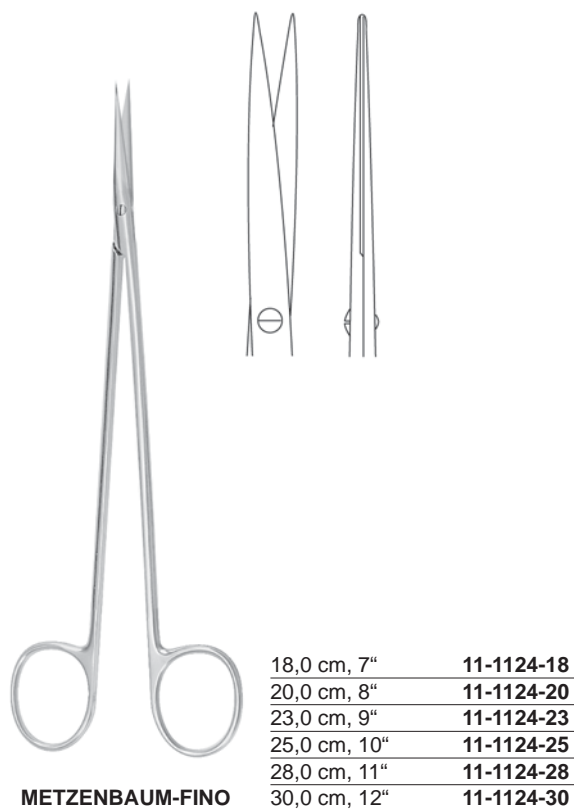
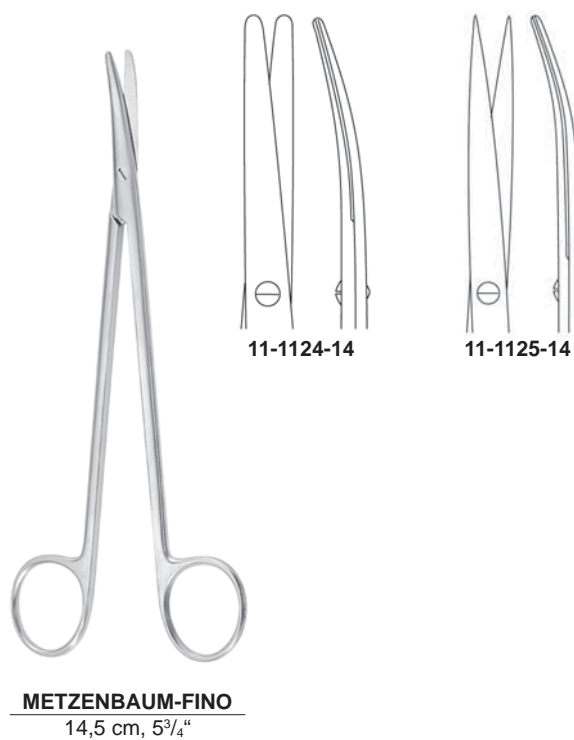
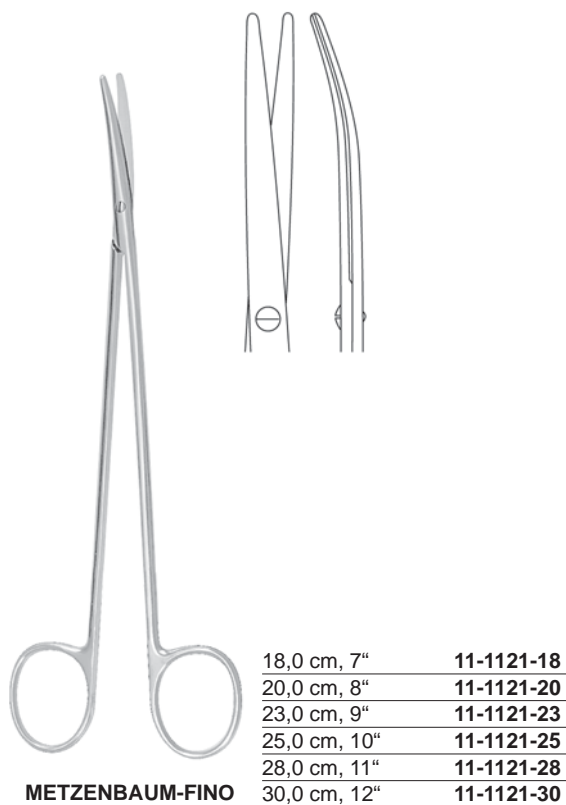

Präparierscheren
Dissecting Scissors
Tijeras de disección
Forbici per dissezione

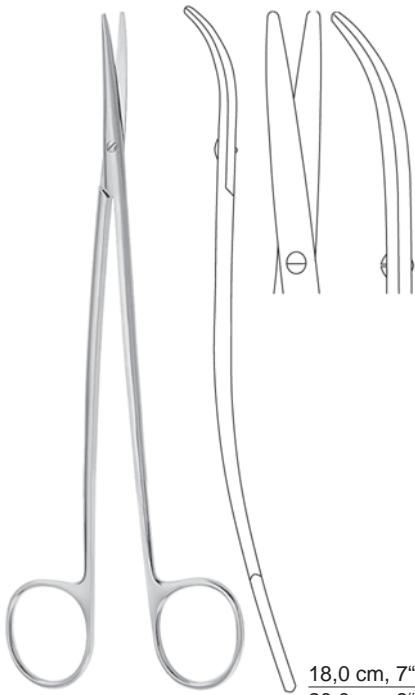

METZENBAUM-FINO S

18,0 cm, 7"	11-1127-18
20,0 cm, 8"	11-1127-20
23,0 cm, 9"	11-1127-23

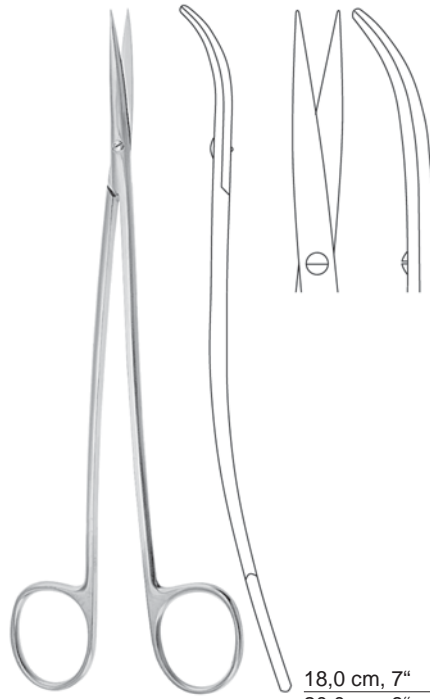

METZENBAUM-FINO S

18,0 cm, 7"	11-1129-18
20,0 cm, 8"	11-1129-20
23,0 cm, 9"	11-1129-23



METZENBAUM-LAHEY
14,0 cm, 5½" **11-1137-14**

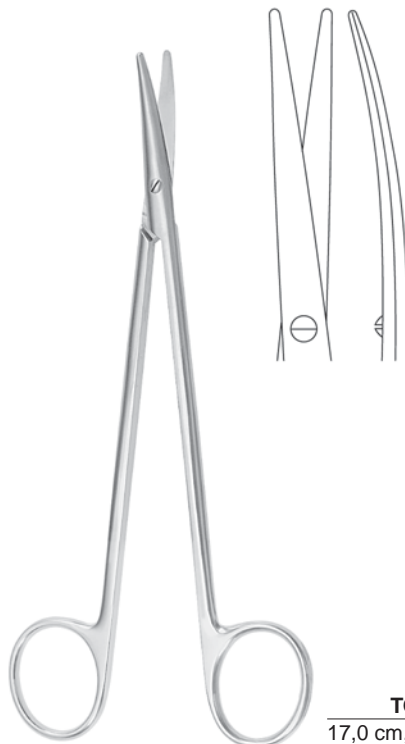

TOENNIS-ADSON
17,0 cm, 6¾" **11-1139-17**

Präparierscheren
 Dissecting Scissors
 Tijeras de disección
 Forbici per dissezione

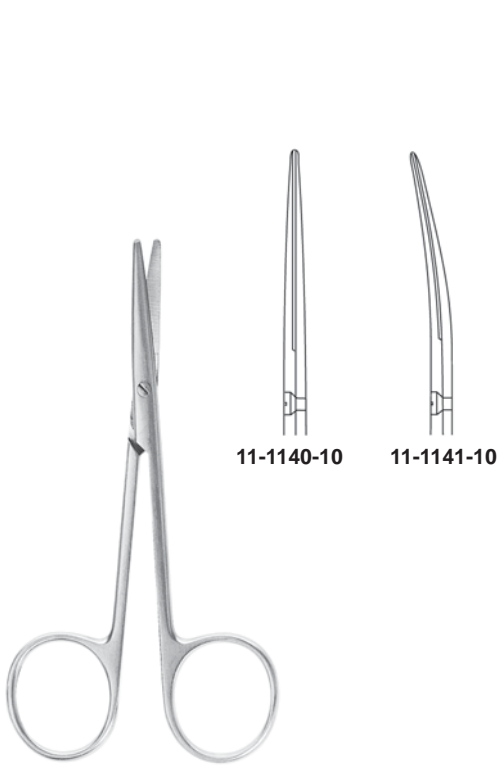

11-1140-10

11-1141-10

BABY-LEXER
 10,0 cm, 4"



LEXER

16,0 cm, 6¹/₄"
 21,0 cm, 8¹/₄"

11-1140-16
11-1140-21



LEXER

16,0 cm, 6¹/₄"
 21,0 cm, 8¹/₄"

11-1141-16
11-1141-21

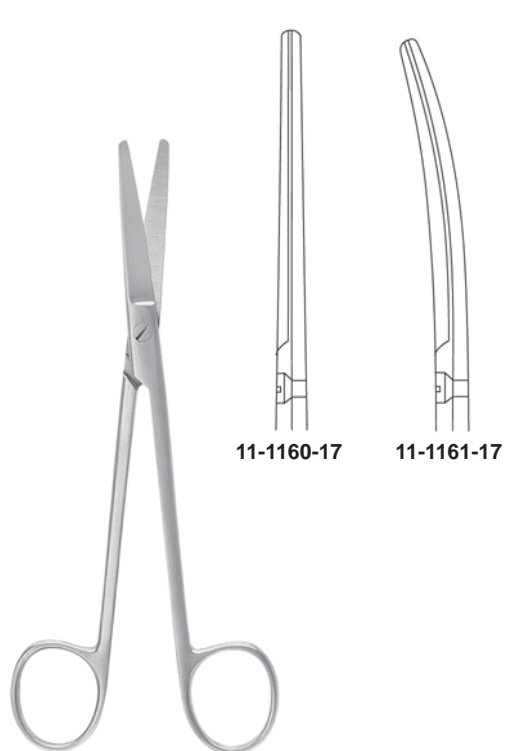

11-1160-17

11-1161-17

MIXTER

17,0 cm, 6³/₄"

Präparierscheren, feine chirurgische Scheren
Dissecting Scissors, fine surgical scissors
Tijeras de disección, tijeras finas para cirugía
Forbici per dissezione, forbici fine per chirurgia



KILNER (RAGNELL)

12,0 cm, 4 ³ / ₄ "	11-1200-12
15,0 cm, 6"	11-1200-15
18,0 cm, 7"	11-1200-18
20,0 cm, 8"	11-1200-20



KILNER (RAGNELL)

12,0 cm, 4 ³ / ₄ "	11-1201-12
15,0 cm, 6"	11-1201-15
18,0 cm, 7"	11-1201-18
20,0 cm, 8"	11-1201-20



REYNOLDS

15,0 cm, 6"	11-1210-15
18,0 cm, 7"	11-1210-18



REYNOLDS

15,0 cm, 6"	11-1211-15
18,0 cm, 7"	11-1211-18
20,0 cm, 8"	11-1211-20
23,0 cm, 9"	11-1211-23
25,0 cm, 10"	11-1211-25

Feine chirurgische Scheren
 Fine surgical scissors
 Tijeras finas para cirugía
 Forbici fine per chirurgia



19,0 cm, 7½"
 11-1217-19

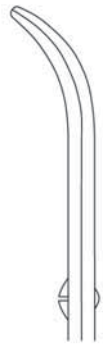

25,0 cm, 10"
 11-1217-25

THOREK



11-1220-15



11-1221-15

15,0 cm, 6"

Nerv-Präparierscheren
 Nerve dissecting scissors
 Tijeras para nervios
 Forbici per dissezione di nervi



11-1224-14

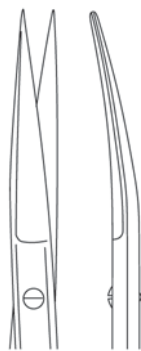

11-1225-14

SANVENERO
 14,0 cm, 5½"



11-1228-14

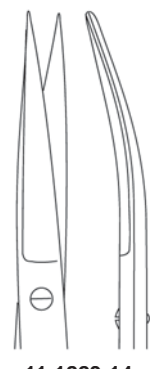

11-1229-14

JOSEPH
 14,0 cm, 5½"

Feine chirurgische Scheren
 Fine surgical scissors
 Tijeras finas para cirugía
 Forbici fine per chirurgia

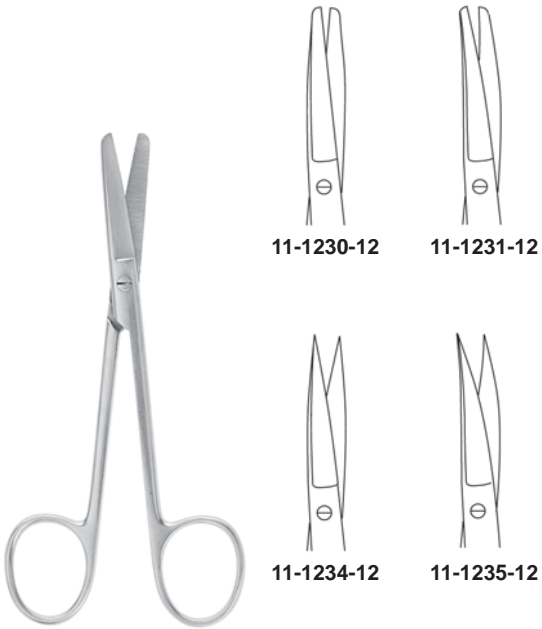

WAGNER
 12,0 cm, 4³/₄"



STRABISMUS
 11,5 cm, 4¹/₂"



IRIS

9,0 cm, 4 ¹ / ₈ "	11-1244-09
10,5 cm, 4 ¹ / ₈ "	11-1244-10
11,5 cm, 4 ¹ / ₂ "	11-1244-11

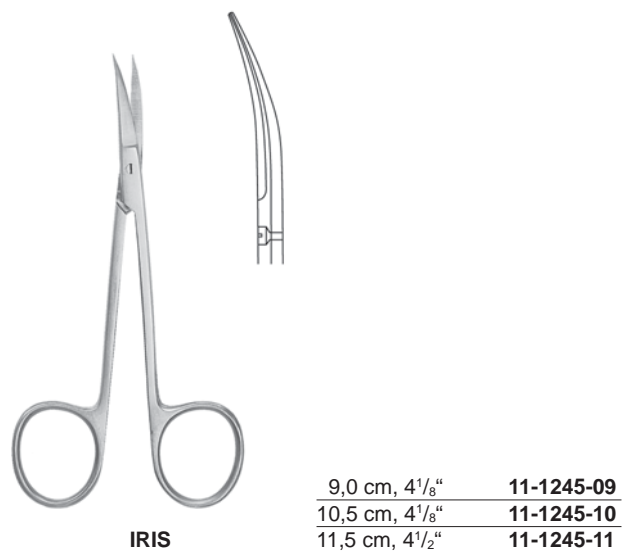

IRIS

9,0 cm, 4 ¹ / ₈ "	11-1245-09
10,5 cm, 4 ¹ / ₈ "	11-1245-10
11,5 cm, 4 ¹ / ₂ "	11-1245-11

Feine chirurgische Scheren
 Fine surgical scissors
 Tijeras finas para cirugía
 Forbici fine per chirurgia



IRIS

10,5 cm, 4¹/₈" **11-1250-10**
 11,5 cm, 4¹/₂" **11-1250-11**



IRIS

10,5 cm, 4¹/₈" **11-1251-10**
 11,5 cm, 4¹/₂" **11-1251-11**



11,5 cm, 4¹/₂"
11-1261-11



11,5 cm, 4¹/₂"
11-1263-11

Feine chirurgische Scheren
Fine surgical scissors
Tijeras finas para cirugía
Forbici fine per chirurgia



12,0 cm, 4³/₄"



11-1264-12



11-1265-12



MOD. BONN
8,0 cm, 3¹/₄"
11-1270-08



MOD. BONN
8,0 cm, 3¹/₄"
11-1271-08



MOD. BONN
8,0 cm, 3¹/₄"
11-1273-08



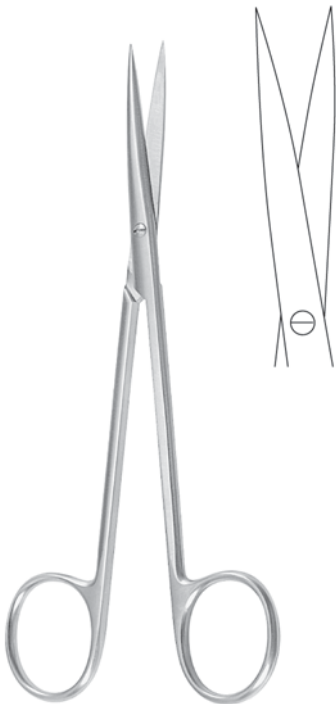

BROPHY (SULLIVAN)
 14,0 cm, 5½"
 11-1276-14



BROPHY (SULLIVAN)
 14,0 cm, 5½"
 11-1277-14

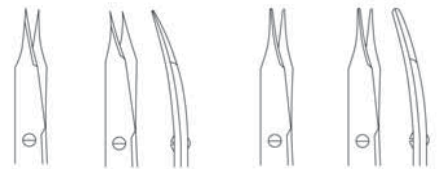

10,5 cm, 4⅛"	11-1290-10	11-1291-10	11-1294-10	11-1295-10
11,5 cm, 4½"	11-1290-11	11-1291-11	11-1294-11	11-1295-11

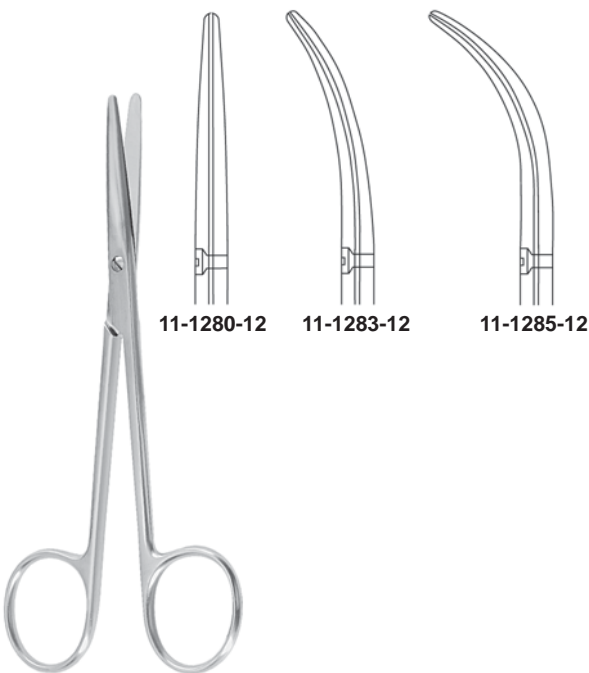

LANDOLT
 12,5 cm, 5"



STEVENS

Chirurgische Scheren
 Surgical scissors
 Tijeras para cirugía
 Forbici per chirurgia



Inzisionsscheren
 Incision scissors
 Tijeras para incisión
 Forbici vascolare e per fistole

13,0 cm, 5" **11-1300-13**
 14,5 cm, 5³/₄" **11-1300-14**



Inzisionsscheren
 Incision scissors
 Tijeras para incisión
 Forbici vascolare e per fistole

11-1302-16
 16,5 cm, 3⁶/₂"



RICHTER
 14,5 cm, 5³/₄"
11-1310-14



LAWSON TAIT
 12,5 cm, 5"
11-1312-12



FERGUSON
 16,5 cm, 6¹/₄" **11-1315-16**
 18,0 cm, 7" **11-1315-18**



TOENNIS
 18,0 cm, 7"
11-1324-18

Chirurgische Scheren, Ligaturscheren
 Surgical scissors, Ligature Scissors
 Tijeras para cirugía, Tijeras para ligaduras
 Forbici per chirurgia, Forbici per legature



TOENNIS
 18,0 cm, 7"
 11-1325-18



HALLE
 19,0 cm, 7½"
 11-1341-19

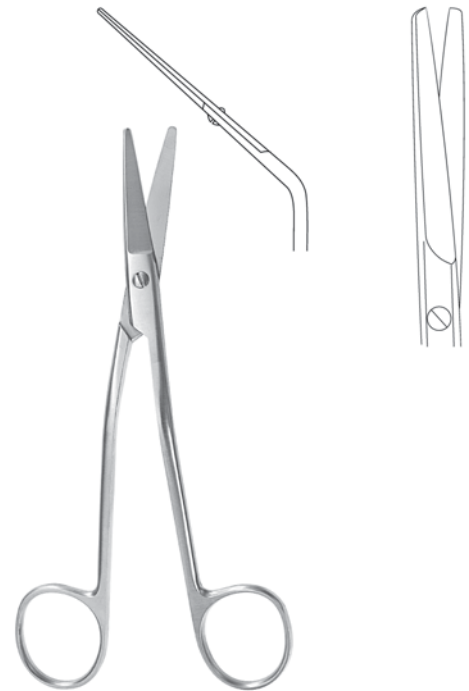

FOMON
 15,0 cm, 6"
 11-1343-15



SPENCER
 9,0 cm, 4⅞" 11-1400-09
 10,5 cm, 4⅞" 11-1400-10
 13,0 cm, 5" 11-1400-13



LITTAUER
 11,5 cm, 4¼" 11-1402-11
 14,0 cm, 5½" 11-1402-14

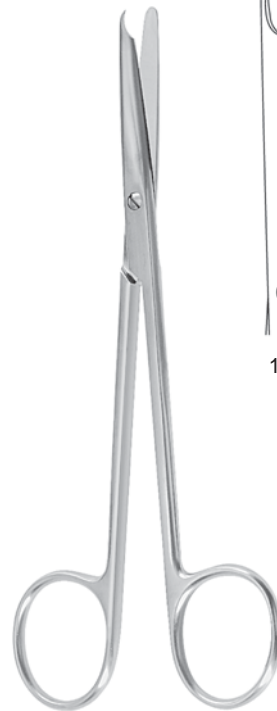

BUCK

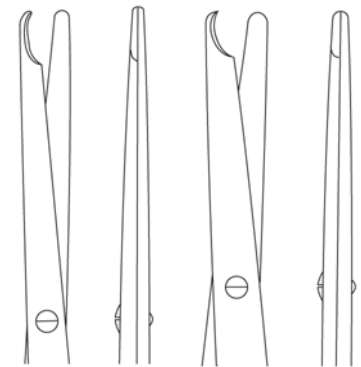

14,5 cm, 5¾"
 11-1404-14

18,0 cm, 7"
 11-1404-18

Ligaturscheren, Neurochirurgische Scheren
Ligature Scissors, Neurosurgical Scissors
Tijeras para ligaduras, Tijeras para Neurocirugía
Forbici per legature, Forbici per Neurochirurgia

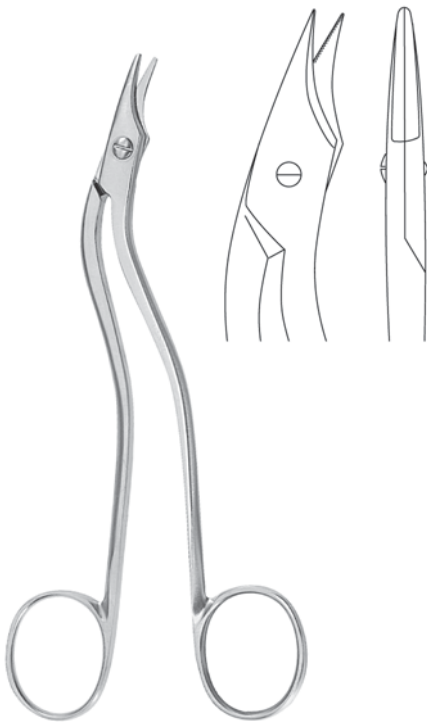

HEATH
 16,0 cm, 6¹/₄"
 11-1408-16



NORTHBENT
 9,0 cm, 3¹/₂"
 11-1411-19



NORTHBENT
 13,0 cm, 5"
 11-1413-13



EISELSBERG
 12,0 cm, 4³/₄"
 11-1415-12

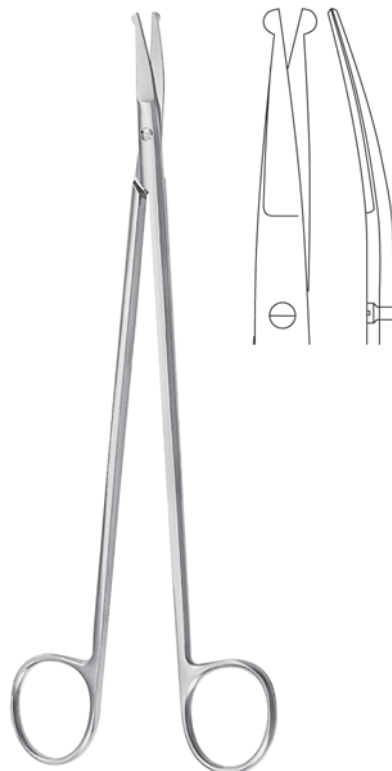

STRULLY
 22,0 cm, 8⁵/₈"
 11-1450-22

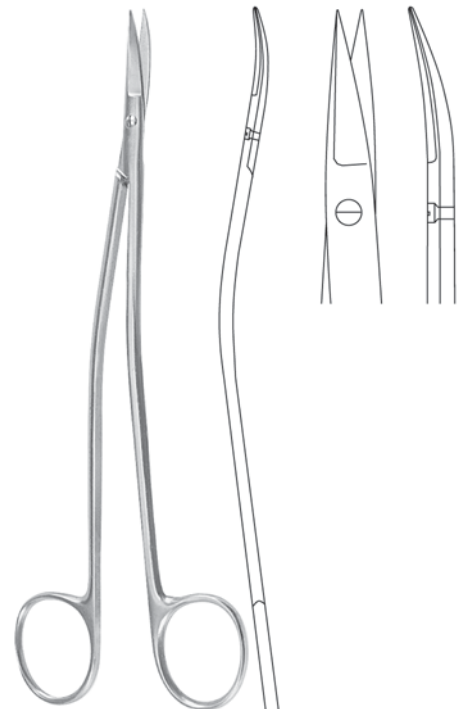

DANDY
 17,0 cm, 6³/₄"
 11-1453-17

Neurochirurgische Scheren, Tonsillenscheren, Nasenscheren
 Neurosurgical Scissors, Tonsil Scissors, Nasal Scissors
 Tijeras para Neurocirugía, Tijeras para amígdalas, Tijeras para el tabique nasal
 Forbici per Neurochirurgia, Forbici per tonsille, Forbici per il setto nasale

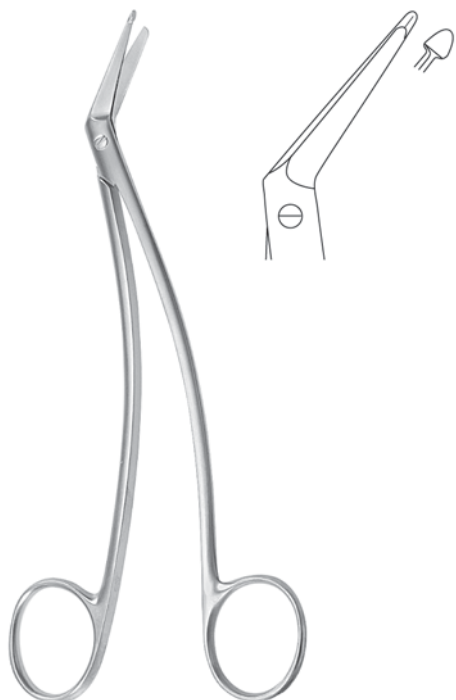

SCHMIEDEN-TAYLOR
 17,0 cm, 6³/₄"
 11-1457-17

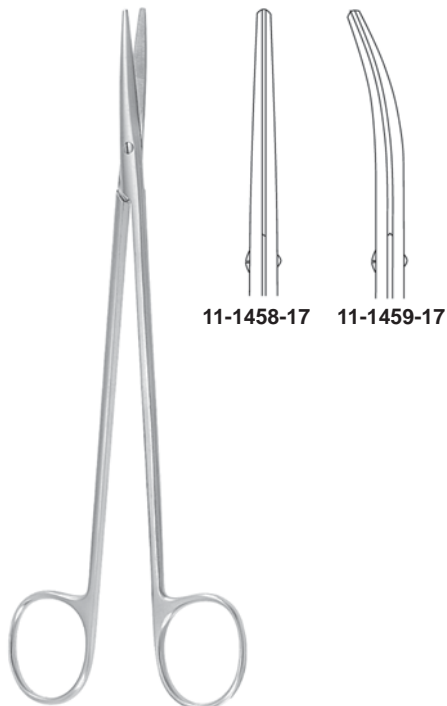

LINCOLN
 17,0 cm, 6³/₄"



HEYMANN
 18,0 cm, 7"
 11-1501-18

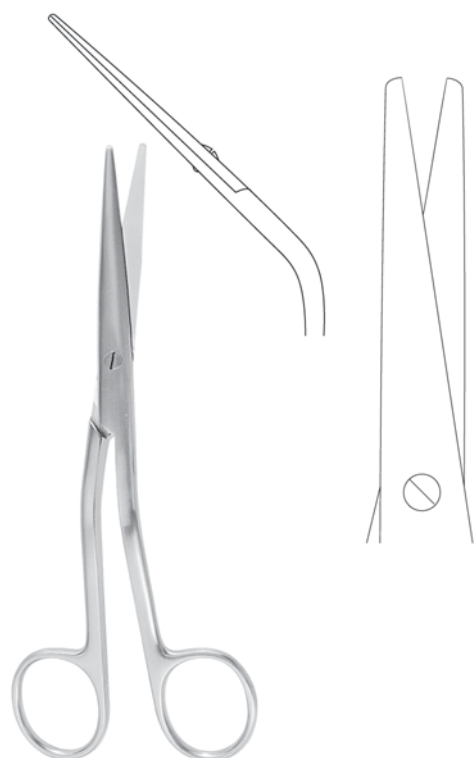

COTTLE
 16,0 cm, 6¹/₄"
 11-1511-16



KIRSTEN
 18,0 cm, 7"
 11-1517-18



CAPLAN
 22,0 cm, 8⁵/₈"
 11-1519-22

Tonsillenscheren, Nasenscheren, Gefäßscheren
Tonsil Scissors, Nasal Scissors, Vascular Scissors
Tijeras para amígdalas, Tijeras para el tabique nasal, Tijeras vasculares
Forbici per tonsille, Forbici per il setto nasale, Forbici vascolari



BOETTCHER
 18,0 cm, 7"
 11-1521-18

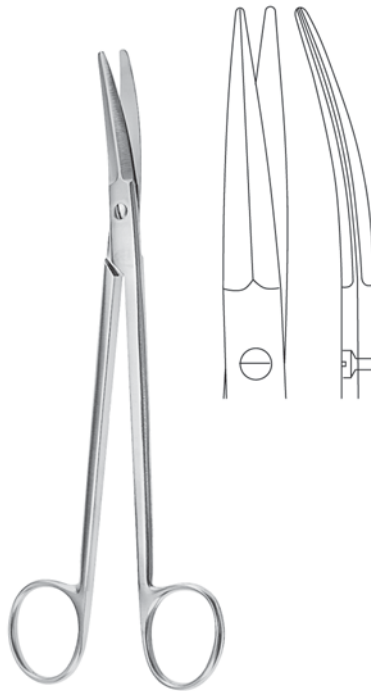

PRINCE
 17,5 cm, 6⁵/₈"
 11-1523-17

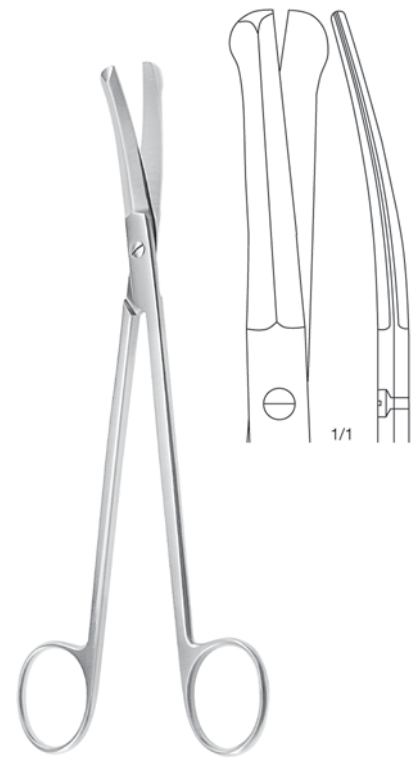

GOOD
 19,0 cm, 7¹/₂"
 11-1525-19



CARTILAGE
 20,0 cm, 8"
 11-1528-20

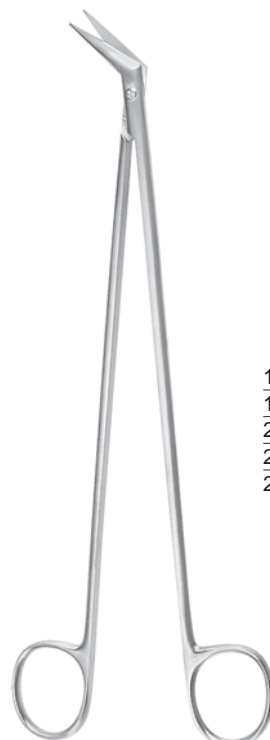

DE BAKEY

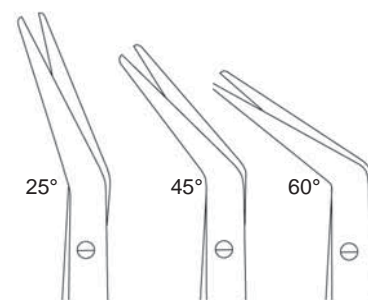

17,5 cm, 6 ⁵ / ₈ "	11-1540-25	11-1540-45	11-1540-60
19,5 cm, 7 ³ / ₄ "	11-1541-25	11-1541-45	11-1541-60
21,0 cm, 8 ¹ / ₄ "	11-1542-25	11-1542-45	11-1542-60
23,0 cm, 9"	11-1543-25	11-1543-45	11-1543-60
28,0 cm, 11"	11-1544-25	11-1544-45	11-1544-60

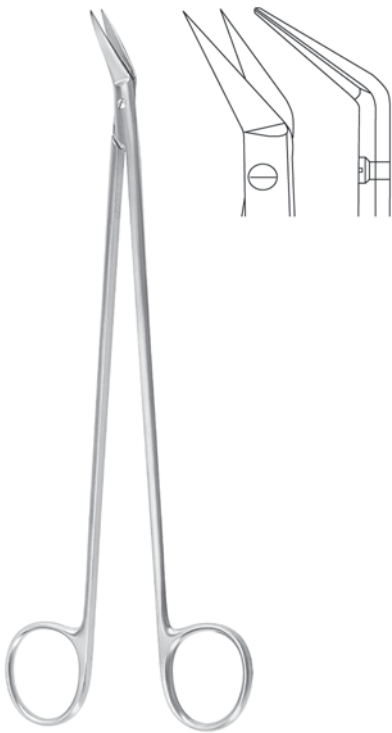

POTTS-SMITH
 18,0 cm, 7"
 11-1547-18

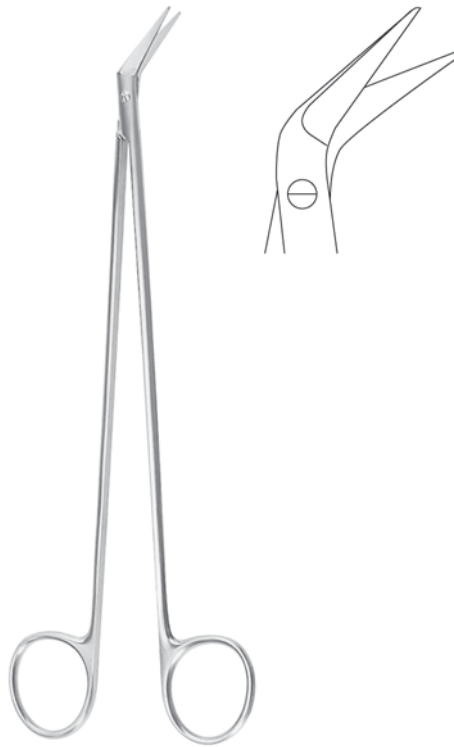

POTTS DE MARTEL
 21,0 cm, 8¹/₄" 11-1548-21
 24,0 cm, 9¹/₂" 11-1548-24



DIETRICH-HEGEMANN
 19,0 cm, 7¹/₂"

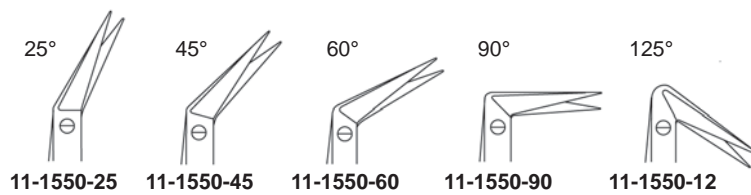

Gefäßscheren
 Vascular Scissors
 Tijeras vasculares
 Forbici vascolari



DIETRICH
 20,0 cm, 7 1/2"
 11-1552-12

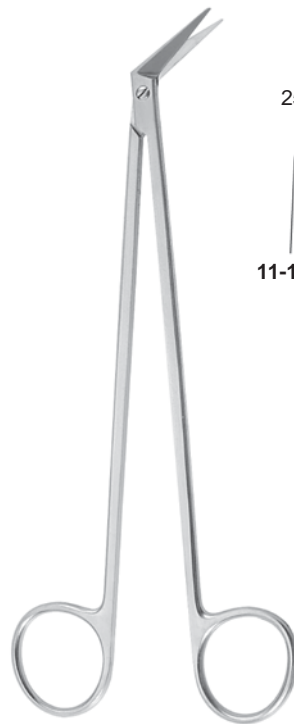

POTTS-SMITH
 19,0 cm, 7 1/2"

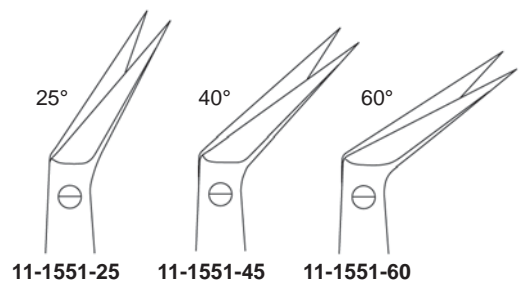

11-1551-25 11-1551-45 11-1551-60

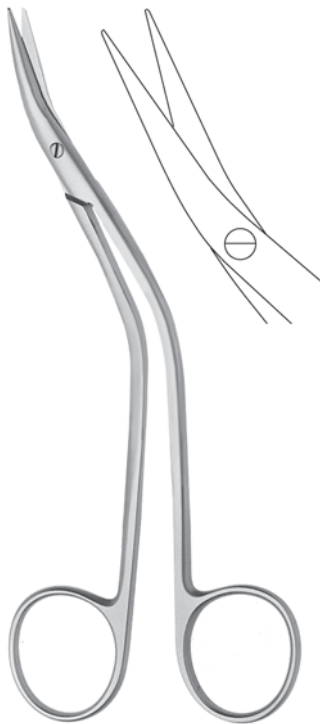

DE BAKEY
 15,5 cm, 6"
 11-1560-15

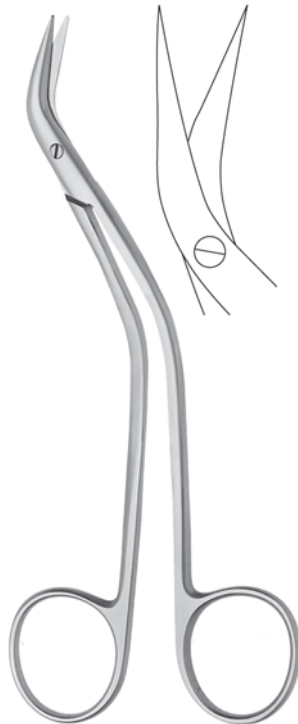

DE BAKEY
 15,5 cm, 6"
 11-1561-15



DE BAKEY
 15,5 cm, 6"
 11-1562-15

Gefäßscheren, Gynäkologische Scheren
 Vascular Scissors, Gynecology scissors
 Tijeras vasculares, Tijeras para ginecología
 Forbici vascolari, Forbici per ginecologia



MC INDOE
 19,0 cm, 7½"
 11-1570-19



geknöpftes Blatt
 probe-pointed blade
 punta botonda
 lame bottonuta

11,5 cm, 4½"
 11-1572-11



CRAFOORD
 30,0 cm, 12"
 11-1575-30



SATINSKY
 15,5 cm, 9⅝"
 11-1577-24

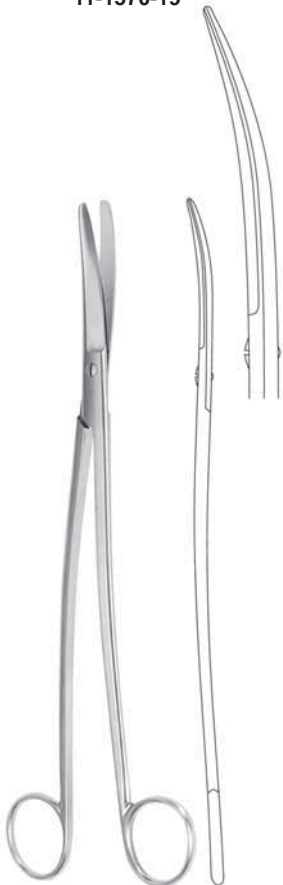

KLINGENBERG-LOTH
 23,0 cm, 9"
 11-1579-23



SIMS

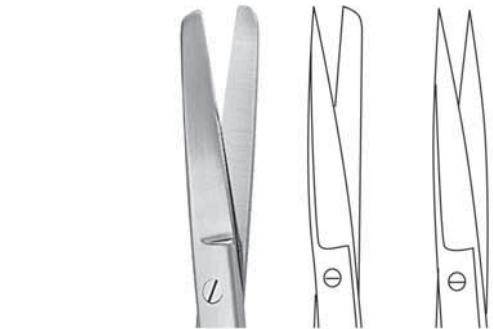

20,0 cm, 8"	11-1600-20	11-1602-20	11-1604-20
23,0 cm, 9"	11-1600-23	11-1602-23	11-1604-23

Gynäkologische Scheren
 Gynecology scissors
 Tijeras para ginecología
 Forbici per ginecologia



SIMS

20,0 cm, 8"	11-1601-20	11-1603-20	11-1605-20
23,0 cm, 9"	11-1601-23	11-1603-23	11-1605-23

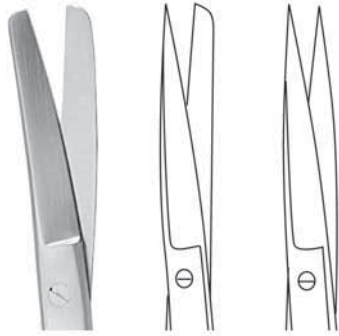

SIEBOLD
 24,0 cm, 9½"



BOZEMANN
 22,0 cm, 8¾"



DOYEN

16,0 cm, 6¼"	11-1610-16	11-1611-16	11-1612-16
17,5 cm, 6⅝"	11-1610-17	11-1611-17	



KELLY

16,0 cm, 6¼"	11-1634-16
18,0 cm, 7"	11-1634-18

Fistelscheren
 Fistula scissors
 Tijeras para fistulas
 Forbici per fistole

Gynäkologische Scheren, Darmscheren
 Gynecology scissors, Enterotomy Scissors
 Tijeras para ginecología, Tijeras enterótomos
 Forbici per ginecologia, Forbici per enterotomia



Fistelscheren
 Fistula scissors
 Tijeras para fistulas
 Forbici per fistole

KELLY

16,0 cm, 6¹/₄" **11-1635-16**
 18,0 cm, 7" **11-1635-18**



WERTHEIM

19,5 cm, 7³/₄" **11-1640-19**
 22,5 cm, 8³/₄" **11-1640-23**

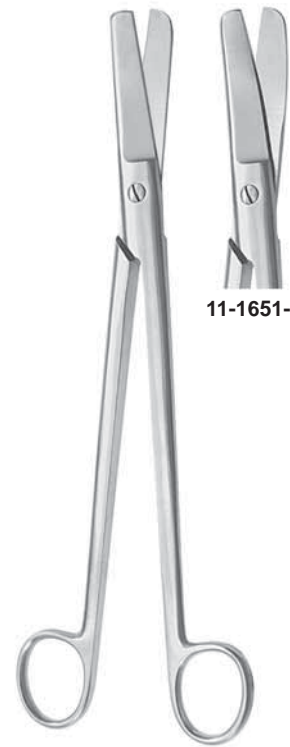

11-1651-18

DUBOIS

27,0 cm, 10⁵/₈"
11-1650-18



21,0 cm, 8¹/₄"
11-1670-21



21,0 cm, 8¹/₄"
11-1672-21



21,0 cm, 8¹/₄"
11-1674-21



LLOYD-DAVIES
 27,0 cm, 10⁵/₈"
11-1677-27

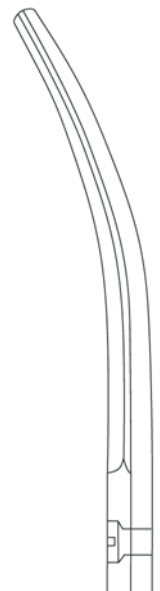

Lungenlappen- und Rektumscheren, Lungenscheren, Dammscheren
 Lobectomy and Rectal Scissors, Lobectomy Scissors, Episiotomy Scissors
 Tijeras para lobectomía y recto, Tijera para lobectomía, Tijeras para episiotomía
 Forbici per lobo polmonare e per il retto, Forbici per lobo, Forbici per episiotomia

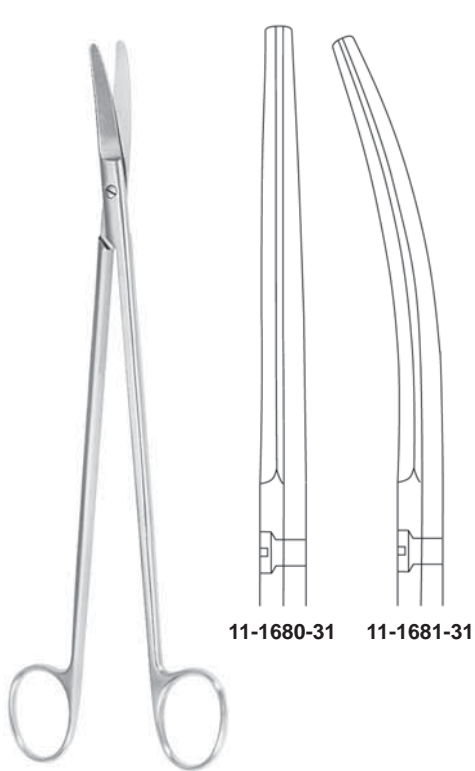

STIELZNER
 31,0 cm, 12¹/₄"

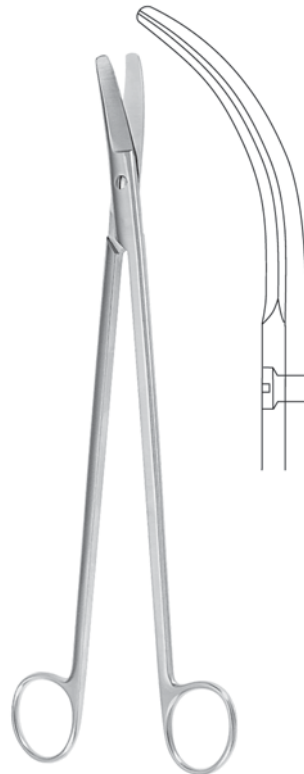

RECTAL
 32,5 cm, 12³/₄"
 11-1685-32

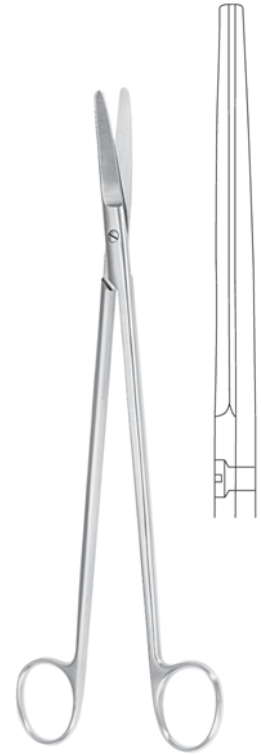

WILLAUER
 25,0 cm, 9³/₄" 11-1688-25
 28,0 cm, 11" 11-1688-28

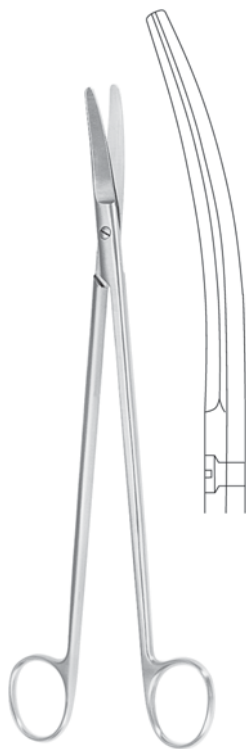

WILLAUER
 25,0 cm, 9³/₄" 11-1689-25
 28,0 cm, 11" 11-1689-28



POTTS-SMITH
 19,0 cm, 7¹/₂"
 11-1691-19



FINOCHIETTO
 32,5 cm, 10⁵/₈"
 11-1693-27

Lungenscheren, Dammscheren, Nabelschnurscheren
 Lobectomy Scissors, Episiotomy Scissors, Umbilical Cord Scissors
 Tijera para lobectomía, Tijeras para episiotomía, Tijeras umbilicales
 Forbici per lobo, Forbici per episiotomia, Forbici ombelicali



WALDMANN
 18,0 cm, 7"
 11-1695-18



BRAUN-STADLER
 14,5 cm, 5³/₄" 11-1701-14
 20,0 cm, 8" 11-1701-20



20,0 cm, 8"
 11-1703-20



MOD. USA
 10,5 cm, 4¹/₈"
 11-1706-10



BUSCH
 13,5 cm, 5³/₈" 11-1707-13
 16,0 cm, 6¹/₄" 11-1707-16



SCHUMACHER
 16,0 cm, 16¹/₄"
 11-1709-16

Drahtscheren, Verband- und Kleiderstoffscheren
Wire Scissors, Bandage and Cloth Scissors
Cizallas corta-alambres, Tijeras para vendajes y tela
Forbici taglia cavo, Forbici per bendaggi e vestiti



gezahnt
 serrated
 dentada
 dentata

UNIVERSAL
 12,0 cm, 4³/₄"
 11-1800-12



LISTER

9,0 cm, 3 ¹ / ₂ "	11-1900-09
11,0 cm, 4 ³ / ₈ "	11-1900-11
14,0 cm, 5 ¹ / ₂ "	11-1900-14
18,0 cm, 7"	11-1900-18
20,0 cm, 8"	11-1900-20



LISTER

18,5 cm, 7 ¹ / ₄ "	11-1901-18
21,0 cm, 8 ¹ / ₄ "	11-1901-21



LISTER-EXCENTRIC

16,0 cm, 6 ¹ / ₄ "	11-1903-16
19,0 cm, 7 ¹ / ₂ "	11-1903-19

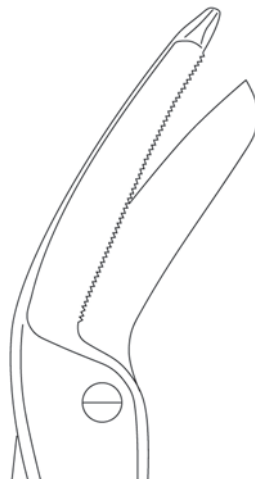

gezahnt
 serrated
 dentada
 dentata



BERGMANN

23,0 cm, 9"	11-1905-23
-------------	-------------------

Verband- und Kleiderstoffscheren, Gipscheren
Bandage and Cloth Scissors, Plaster-of-Paris Shears
Tijeras para vendajes y tela, Cizallas para escayolas
Forbici per bendaggi e vestiti, Cesioie per gessi

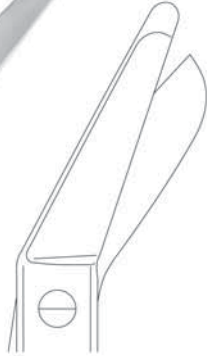

gezahnt
serrated
dentada
dentata



ESMARCH
 20,0 cm, 8" **11-1907-20**
 22,0 cm, 8⁵/₈" **11-1907-22**

KNOWLES
 14,0 cm, 5¹/₂"
11-1920-14

BRUNS
 24,0 cm, 9¹/₂"
11-1909-24
11-1910-24

LORENZ
 23,0 cm, 9"
11-1930-23

bis 134°C autoklavierbar
 autoclavable up to 134°C
 esterilizabile en autoclave hasta 134°C
 Sterilizzabile in autoclave fino 134°C



16,0 cm, 6¹/₄" **11-1940-16**
 18,0 cm, 7" **11-1940-18**
 20,0 cm, 8" **11-1940-20**
 23,0 cm, 9" **11-1940-23**

SMITH
(MOD. USA)



gezahnt
serrated
dentada
dentata

20,0 cm, 8"
11-1941-20



gezahnt
serrated
dentada
dentata

UNIVERSAL
 14,0 cm, 5¹/₂" **11-1950-14**
 16,0 cm, 6¹/₄" **11-1950-16**
 18,0 cm, 7" **11-1950-18**

Chirurgische Scheren mit Hartmetallschneiden
 Surgical Scissors with tungsten carbide edges
 Tijeras para cirugía con filos de carburo tungsteno
 Forbici per chirurgia con lame in carburo di tungsteno



STANDARD

14,5 cm, 5 ³ / ₄ "	12-1000-14
16,5 cm, 6 ¹ / ₂ "	12-1000-16
18,5 cm, 7 ¹ / ₄ "	12-1000-18



STANDARD

14,5 cm, 5 ³ / ₄ "	12-1001-14
16,5 cm, 6 ¹ / ₂ "	12-1001-16
18,5 cm, 7 ¹ / ₄ "	12-1001-18



STANDARD

14,5 cm, 5 ³ / ₄ "	12-1002-14
16,5 cm, 6 ¹ / ₂ "	12-1002-16
18,5 cm, 7 ¹ / ₄ "	12-1002-18



STANDARD

14,5 cm, 5 ³ / ₄ "	12-1003-14
16,5 cm, 6 ¹ / ₂ "	12-1003-16
18,5 cm, 7 ¹ / ₄ "	12-1003-18



STANDARD

14,5 cm, 5 ³ / ₄ "	12-1004-14
16,5 cm, 6 ¹ / ₂ "	12-1004-16
18,5 cm, 7 ¹ / ₄ "	12-1004-18



STANDARD

14,5 cm, 5 ³ / ₄ "	12-1005-14
16,5 cm, 6 ¹ / ₂ "	12-1005-16
18,5 cm, 7 ¹ / ₄ "	12-1005-18

Chirurgische Scheren mit Hartmetallschneiden
 Surgical Scissors with tungsten carbide edges
 Tijeras para cirugía con filos de carburo tungsteno
 Forbici per chirurgia con lame in carburo di tungsteno

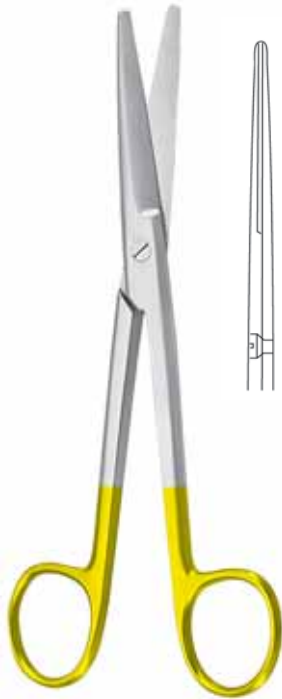

MAYO

14,5 cm, 5 ³ / ₄ "	12-1100-14
17,0 cm, 6 ³ / ₄ "	12-1100-17
23,0 cm, 9"	12-1100-23

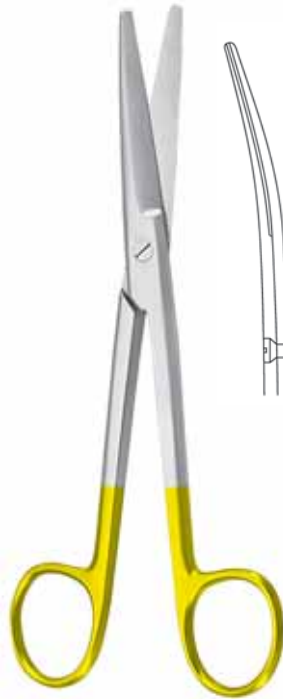

MAYO

14,5 cm, 5 ³ / ₄ "	12-1101-14
17,0 cm, 6 ³ / ₄ "	12-1101-17
23,0 cm, 9"	12-1101-23



MAYO-STILLE

15,0 cm, 6"	12-1102-15
17,0 cm, 6 ³ / ₄ "	12-1102-17



MAYO-STILLE

15,0 cm, 6"	12-1103-15
17,0 cm, 6 ³ / ₄ "	12-1103-17



LEXER

16,0 cm, 6 ¹ / ₄ "	12-1140-16
21,0 cm, 8 ¹ / ₄ "	12-1140-21



LEXER

16,0 cm, 6 ¹ / ₄ "	12-1141-16
21,0 cm, 8 ¹ / ₄ "	12-1141-21

Präparierscheren mit Hartmetallschneiden
Dissecting Scissors with tungsten carbide edges
Tijeras para disección con filos de carburo tungsteno
Forbici per dissezione con lame in carburo di tungsteno

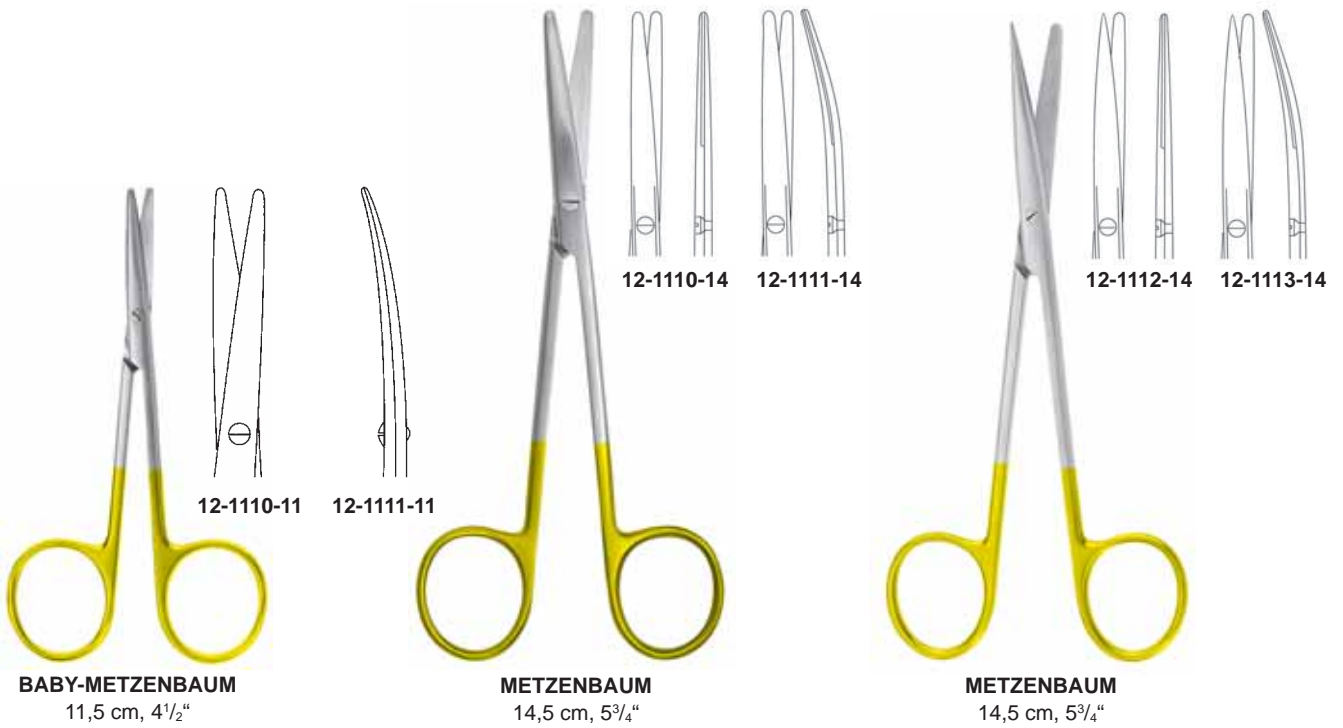



18,0 cm, 7"	12-1112-18
20,0 cm, 8"	12-1112-20
23,0 cm, 9"	12-1112-23
25,0 cm, 10"	12-1112-25
28,0 cm, 11"	12-1112-28
30,0 cm, 12"	12-1112-30

METZENBAUM

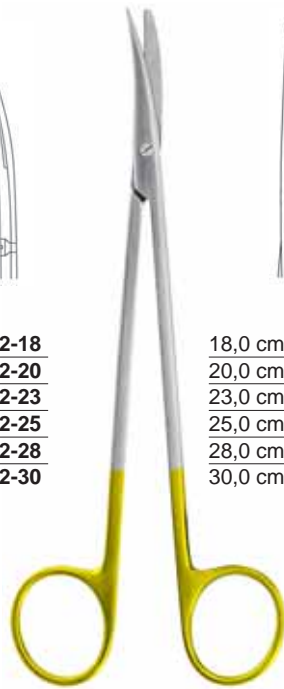

18,0 cm, 7"	12-1113-18
20,0 cm, 8"	12-1113-20
23,0 cm, 9"	12-1113-23
25,0 cm, 10"	12-1113-25
28,0 cm, 11"	12-1113-28
30,0 cm, 12"	12-1113-30

METZENBAUM

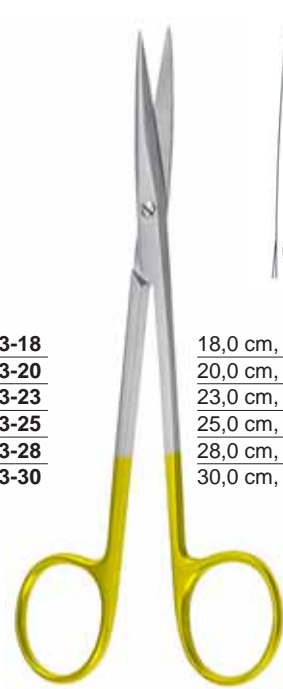

18,0 cm, 7"	12-1114-18
20,0 cm, 8"	12-1114-20
23,0 cm, 9"	12-1114-23
25,0 cm, 10"	12-1114-25
28,0 cm, 11"	12-1114-28
30,0 cm, 12"	12-1114-30

METZENBAUM

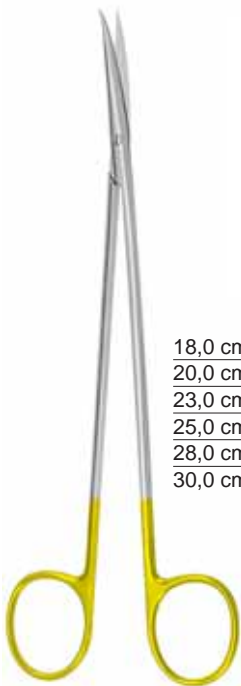

18,0 cm, 7"	12-1115-18
20,0 cm, 8"	12-1115-20
23,0 cm, 9"	12-1115-23
25,0 cm, 10"	12-1115-25
28,0 cm, 11"	12-1115-28
30,0 cm, 12"	12-1115-30

METZENBAUM

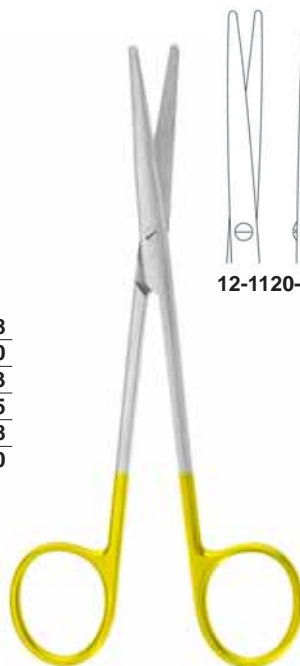

12-1120-14 12-1121-14

METZENBAUM-FINO
14,5 cm, 5³/₄"



12-1124-14 12-1125-14

METZENBAUM-FINO
14,5 cm, 5³/₄"

Präparierscheren mit Hartmetallschneiden
Dissecting Scissors with tungsten carbide edges
Tijeras para disección con filos de carburo tungsteno
Forbici per dissezione con lame in carburo di tungsteno

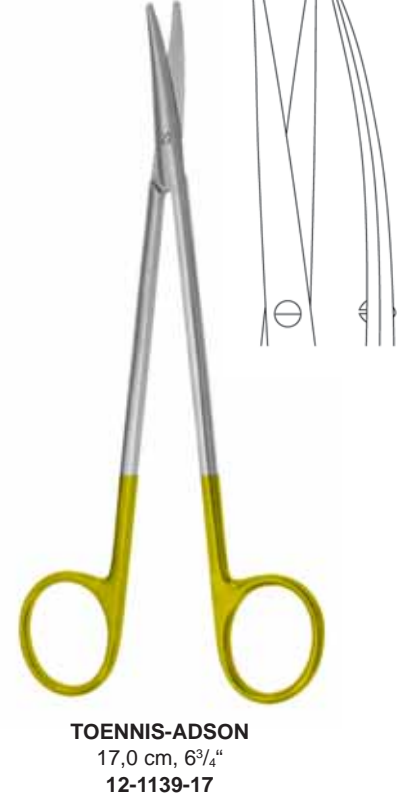
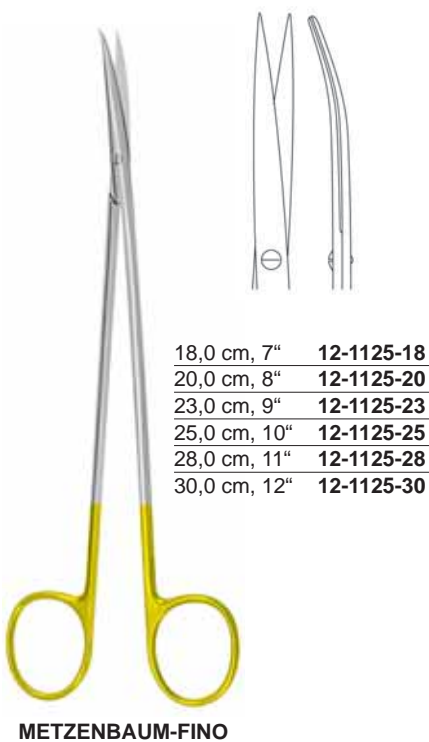
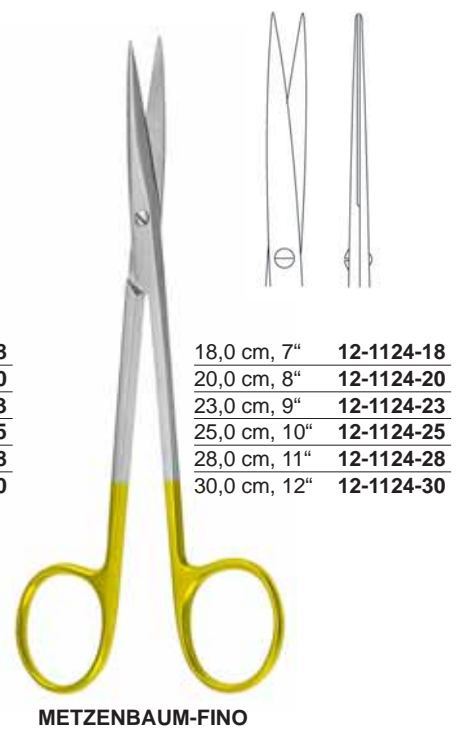
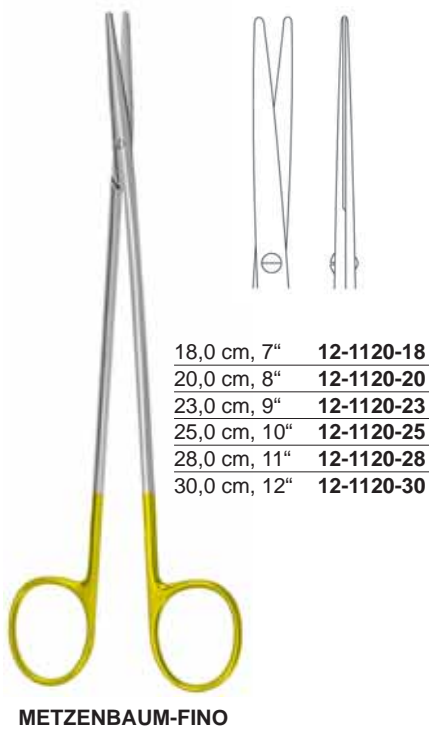

Präparierscheren mit Hartmetallschneiden
 Dissecting Scissors with tungsten carbide edges
 Tijeras para disección con filos de carburo tungsteno
 Forbici per dissezione con lame in carburo di tungsteno

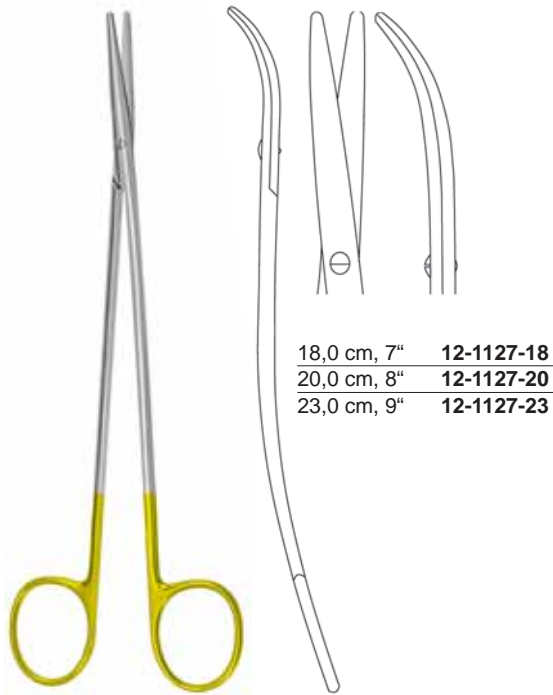

18,0 cm, 7"	12-1127-18
20,0 cm, 8"	12-1127-20
23,0 cm, 9"	12-1127-23

METZENBAUM-FINO S

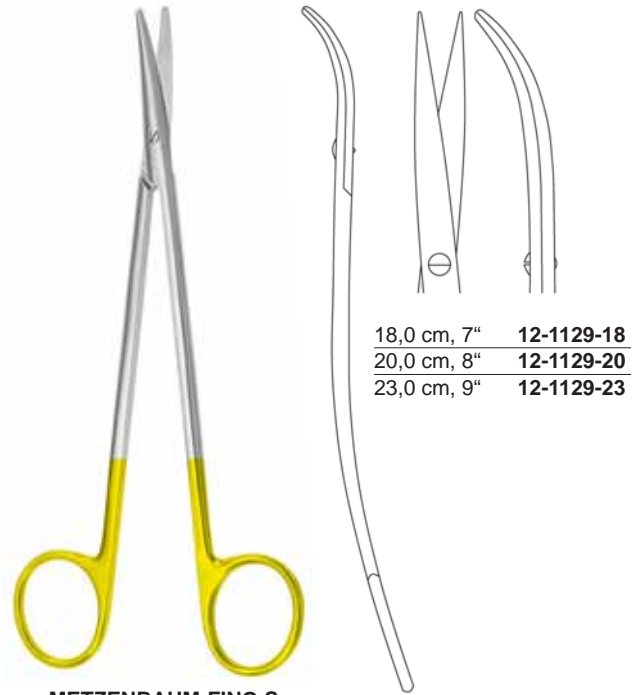

18,0 cm, 7"	12-1129-18
20,0 cm, 8"	12-1129-20
23,0 cm, 9"	12-1129-23

METZENBAUM-FINO S



REYNOLDS
 15,0 cm, 6"
 12-1210-15



REYNOLDS
 15,0 cm, 6"
 12-1211-15



HYSTEREKTOMY
 25,5 cm, 10"
 12-1663-25



HYSTEREKTOMY
 25,0 cm, 9³/₄"
 12-1665-25

Gynäkologische Scheren mit Hartmetallschneiden
 Gynecology Scissors with tungsten carbide edges
 Tijeras para ginecología con filos de carburo tungsteno
 Forbici per ginecologia con lame in carburo di tungsteno



SIMS



20,0 cm, 8"	12-1600-20	12-1602-20	12-1604-20
23,0 cm, 9"	12-1600-23	12-1602-23	12-1604-23



SIMS



20,0 cm, 8"	12-1601-20	12-1603-20	12-1605-20
23,0 cm, 9"	12-1601-23	12-1603-23	12-1605-23

Gefäßscheren mit Hartmetallschneiden
 Vascular Scissors with tungsten carbide edges
 Tijeras vasculares con filos de carburo tungsteno
 Forbici vascolari con lame in carburo di tungsteno

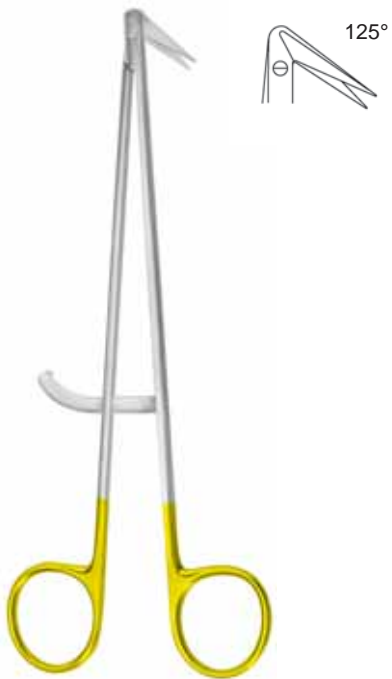

DIETRICH
 17,5 cm, 6⁵/₈"
 12-1552-17



POTTS DE MARTEL
 24,0 cm, 9¹/₂"
 12-1548-24



DE BAKEY

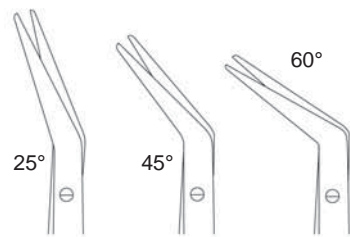

20,0 cm, 8"	12-1543-25	12-1543-45	12-1543-60
23,0 cm, 9"	12-1545-25	12-1545-45	12-1545-60

Gefäßscheren mit Hartmetallschneiden
Vascular Scissors with tungsten carbide edges
Tijeras vasculares con filos de carburo tungsteno
Forbici vascolari con lame in carburo di tungsteno

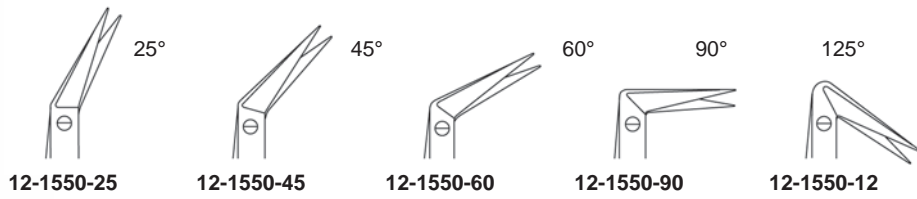

DIETRICH-HEGEMANN
 18,0 cm, 7"

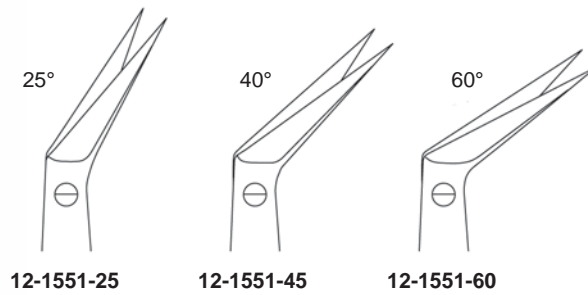

POTTS-SMITH
 18,0 cm, 7 1/2"

Scheren mit Hartmetallschneiden
 Scissors with tungsten carbide edges
 Tijeras con filos de carburo tungsteno
 Forbici con lame in carburo di tungsteno



12-1244-11

12-1245-11

IRIS
 11,5 cm, 4½"



gezahnt
 serrated
 dentada
 dentata

UNIVERSAL
 12,0 cm, 4¾"
 12-1800-12



LISTER
 18,0 cm, 7"
 12-1900-18

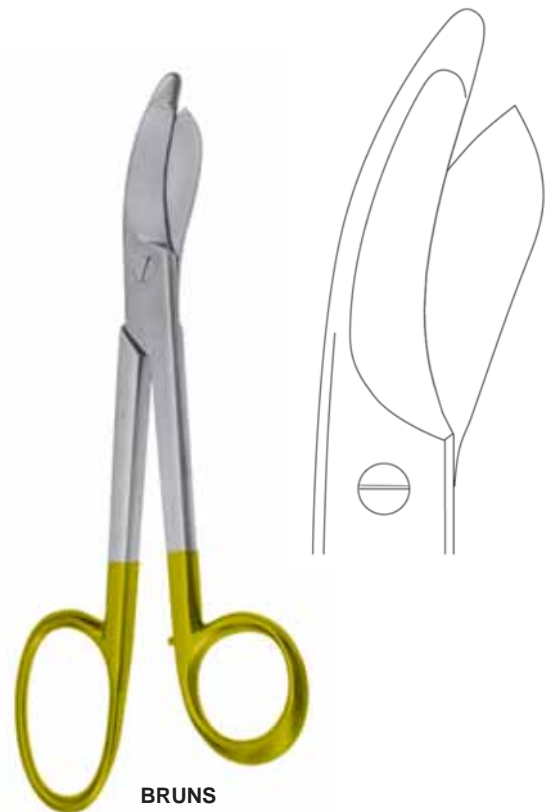

BRUNS
 24,0 cm, 9½"
 12-1909-24

Super-Cut Scheren
 Super-Cut Scissors
 Tijeras Super-Cut
 Forbici Super-Cut



MAYO
 17,0 cm, 6³/₄"

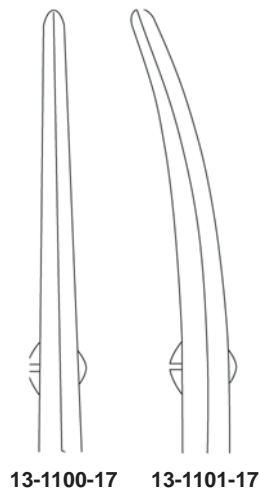

13-1100-17 13-1101-17

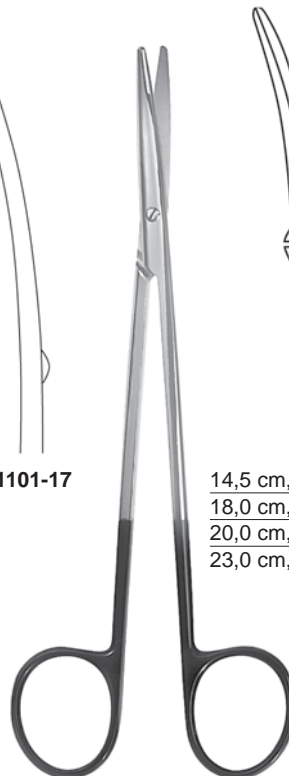

METZENBAUM

14,5 cm, 5³/₄" 13-1111-14
 18,0 cm, 7" 13-1111-18
 20,0 cm, 8" 13-1111-20
 23,0 cm, 9" 13-1111-23

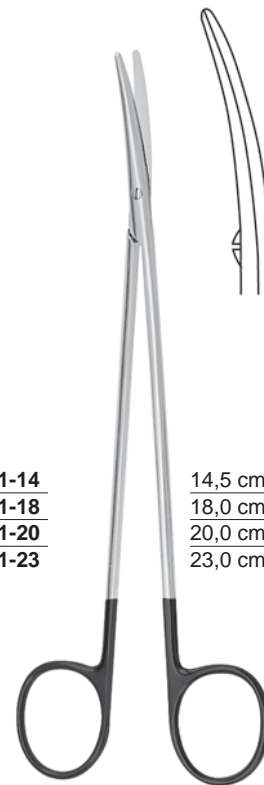

METZENBAUM-FINO

14,5 cm, 5³/₄" 13-1121-14
 18,0 cm, 7" 13-1121-18
 20,0 cm, 8" 13-1121-20
 23,0 cm, 9" 13-1121-23



KAYE FACE LIFT



15,0 cm, 6" 13-1129-15
 19,0 cm, 7¹/₂" 13-1129-19



JABALEY
 13,0 cm, 5"
 13-1130-13



ENDARTERECTOMY
 18,0 cm, 7"
 13-1133-18



TOENNIS-ADSON
 17,0 cm, 6³/₄"
 13-1139-17





STRABISMUS
 11,5 cm, 4 1/2"

JAMISON
 15,0 cm, 6" **13-1218-15**
 18,0 cm, 7" **13-1218-18**

REYNOLDS
 12,5 cm, 5"
13-1210-12

BABY-METZENBAUM
 11,0 cm, 4 3/8" **13-1110-11**
 14,5 cm, 5 3/4" **13-1110-14**



IRIS
 11,0 cm, 4 3/8"
13-1244-11

IRIS
 11,0 cm, 4 3/8"
13-1245-11

STEVENS TENOTOMY
 11,0 cm, 4 3/8"
13-1290-11

STEVENS TENOTOMY
 11,0 cm, 4 3/8"
13-1291-11

Super-Cut Scheren
 Super-Cut Scissors
 Tijeras Super-Cut
 Forbici Super-Cut



PAR TYPE
 12,0 cm, 4³/₄"
 13-1200-12



PAR TYPE
 12,0 cm, 4³/₄"
 13-1201-12



POTTS
 19,0 cm, 7¹/₂"



13-1551-25

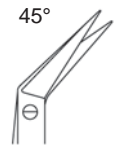

13-1551-45

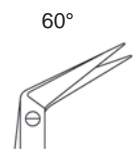

13-1551-60



FOMON
 14,5 cm, 5³/₄"
 13-1343-15



COTTLE
 16,5 cm, 6¹/₂"
 13-1511-16



**Mikro-Scheren
Micro Scissors
Micro-Tijeras
Micro-Forbici**

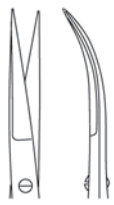

15-1081-11

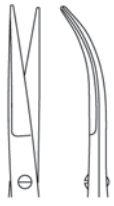

15-1083-11

WESTCOTT
11,0 cm, 4³/₈"



gezahnt
serrated
dentada
dentata

GOMEL

14,0 cm, 5 ¹ / ₂ "	15-1241-14Z
16,0 cm, 6 ¹ / ₄ "	15-1241-16Z



Mikro-Präparierscheren
Micro-dissecting scissors
Micro-tijeras de disección
Micro-forbici per dissezione

HEPP SCHEIDEL

14,0 cm, 5 ¹ / ₂ "	15-1243-14
16,0 cm, 6 ¹ / ₄ "	15-1243-16

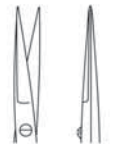
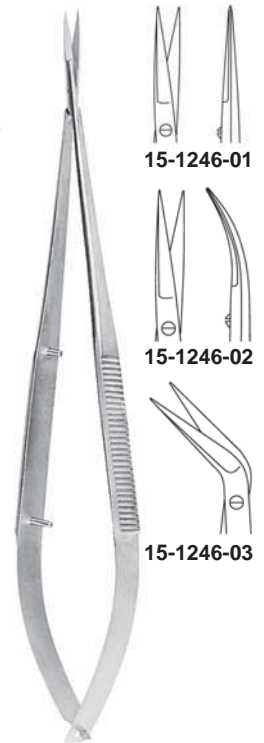

15-1246-01

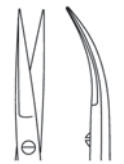

15-1246-02

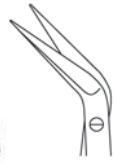

15-1246-03

18,5 cm, 7¹/₄"



STEVENS



18,5 cm, 7 ¹ / ₄ "	15-1290-01	15-1290-02	15-1290-03	15-1290-04
22,5 cm, 8 ³ / ₄ "	15-1291-01	15-1291-02	15-1291-03	15-1291-04



18,5 cm, 7 ¹ / ₄ "	15-1292-01	15-1292-02
22,5 cm, 8 ³ / ₄ "	15-1293-01	15-1293-02

Mikro-Scheren, Mikro-Disektionsscheren
Micro Scissors, Micro Dissecting Scissors
Micro-Tijeras, Micro-Tijeras de disección
Micro-Forbici, Micro-Forbici per dissezione



18,0 cm, 7"



15-1270-25

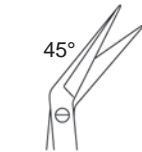

15-1270-45

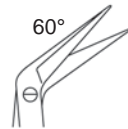

15-1270-60

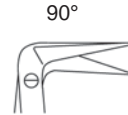

15-1270-90



15-1270-12



15-1271-25

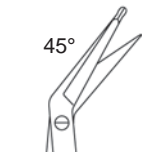

15-1271-45

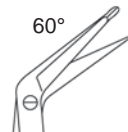

15-1271-60

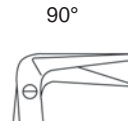

15-1271-90



15-1271-12



15,0 cm, 6"
15-1223-15



15,0 cm, 6"
15-1223-15Z



gezahnt
serrated
dentada
dentata



15,0 cm, 6"
15-1201-15



18,0 cm, 7"
15-1201-18

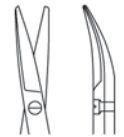

Mikro-Adventitiascheren
Micro Adventitia Scissors
Micro-Tijeras Adventitia
Micro-Forbici Adventitia



15,0 cm, 6"
 15-1232-15



15,0 cm, 6"
 15-1232-15Z



gezahnt
 serrated
 dentada
 dentata



15,0 cm, 6"
 15-1203-15



18,0 cm, 7"
 15-1203-18

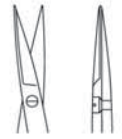

Pinzetten
Forceps
Pinzas
Pinze



Anatomische Pinzetten
 Dissecting Forceps
 Pinzas de disección
 Pinze anatomiche per dissezione



schmal
 narrow
 estrechos
 stretti



schmal
 narrow
 estrechos
 stretti



fein
 fine
 finas
 fini

STANDARD

10,5 cm, 4 ¹ / ₈ "	16-1002-10
11,5 cm, 4 ¹ / ₂ "	16-1002-11
13,0 cm, 5"	16-1002-13
14,5 cm, 5 ³ / ₄ "	16-1002-14
15,0 cm, 6"	16-1002-15
16,0 cm, 6 ¹ / ₄ "	16-1002-16
18,0 cm, 7"	16-1002-18
20,0 cm, 8"	16-1002-20
25,0 cm, 10"	16-1002-25
30,0 cm, 12"	16-1002-30

STANDARD

10,5 cm, 4 ¹ / ₈ "	16-1003-10
11,5 cm, 4 ¹ / ₂ "	16-1003-11
13,0 cm, 5"	16-1003-13
14,5 cm, 5 ³ / ₄ "	16-1003-14
15,0 cm, 6"	16-1003-15
16,0 cm, 6 ¹ / ₄ "	16-1003-16
18,0 cm, 7"	16-1003-18
20,0 cm, 8"	16-1003-20
25,0 cm, 10"	16-1003-25
30,0 cm, 12"	16-1003-30

STANDARD

10,5 cm, 4 ¹ / ₈ "	16-1004-10
11,5 cm, 4 ¹ / ₂ "	16-1004-11
13,0 cm, 5"	16-1004-13
14,5 cm, 5 ³ / ₄ "	16-1004-14
15,0 cm, 6"	16-1004-15
16,0 cm, 6 ¹ / ₄ "	16-1004-16
18,0 cm, 7"	16-1004-18
20,0 cm, 8"	16-1004-20
25,0 cm, 10"	16-1004-25
30,0 cm, 12"	16-1004-30

STANDARD

10,5 cm, 4 ¹ / ₈ "	16-1010-10
11,5 cm, 4 ¹ / ₂ "	16-1010-11
13,0 cm, 5"	16-1010-13
14,5 cm, 5 ³ / ₄ "	16-1010-14
15,0 cm, 6"	16-1010-15
16,0 cm, 6 ¹ / ₄ "	16-1010-16
18,0 cm, 7"	16-1010-18
20,0 cm, 8"	16-1010-20
25,0 cm, 10"	16-1010-25
30,0 cm, 12"	16-1010-30

Anatomische Pinzetten
Dissecting Forceps
Pinzas de disección
Pinze anatomiche per dissezione



fein
fine
finas
fini

10,5 cm, 4 ¹ / ₈ "	16-1011-10
11,5 cm, 4 ¹ / ₂ "	16-1011-11
13,0 cm, 5"	16-1011-13
14,5 cm, 5 ³ / ₄ "	16-1011-14
16,0 cm, 6 ¹ / ₄ "	16-1011-16
18,0 cm, 7"	16-1011-18
20,0 cm, 8"	16-1011-20
25,0 cm, 10"	16-1011-25
30,0 cm, 12"	16-1011-30



fein
fine
finas
fini

mit Stift
with pin
con perno
con espiga

10,5 cm, 4 ¹ / ₈ "	16-1018-10
11,5 cm, 4 ¹ / ₂ "	16-1018-11
13,0 cm, 5"	16-1018-13
14,5 cm, 5 ³ / ₄ "	16-1018-14
16,0 cm, 6 ¹ / ₄ "	16-1018-16
18,0 cm, 7"	16-1018-18
20,0 cm, 8"	16-1018-20
25,0 cm, 10"	16-1018-25
30,0 cm, 12"	16-1018-30



MOD. USA

12,0 cm, 4 ³ / ₄ "	16-1006-10
13,0 cm, 5"	16-1006-13
14,5 cm, 5 ³ / ₄ "	16-1006-14
15,0 cm, 6"	16-1006-15
18,0 cm, 7"	16-1006-18
20,0 cm, 8"	16-1006-20
25,5 cm, 10"	16-1006-25
30,0 cm, 12"	16-1006-30



schmal
narrow
estrechos
stretti

MOD. USA

12,0 cm, 4 ³ / ₄ "	16-1012-11
13,0 cm, 5"	16-1012-13
14,5 cm, 5 ³ / ₄ "	16-1012-14
15,0 cm, 6"	16-1012-15
18,0 cm, 7"	16-1012-18
20,0 cm, 8"	16-1012-20
25,5 cm, 10"	16-1012-25

Anatomische Pinzetten
 Dissecting Forceps
 Pinzas de disección
 Pinze anatomiche per dissezione



ADSON
 12,0 cm, 4³/₄" **16-1070-12**
 15,0 cm, 6" **16-1070-15**



MICRO-ADSON
 12,0 cm, 4³/₄" **16-1076-12**
 15,0 cm, 6" **16-1076-15**



STILLE
 15,0 cm, 6"
16-1008-15



MC INDOE
 15,0 cm, 6"
16-1158-15



TAYLOR
 17,5 cm, 6⁵/₈"
16-1114-17



TAYLOR
 17,5 cm, 6⁵/₈"
16-1115-17



TAYLOR
 18,5 cm, 7¹/₄"
16-1117-18



GERALD
 18,0 cm, 7"
16-1102-18

Anatomische Pinzetten
 Dissecting Forceps
 Pinzas de disección
 Pinze anatomiche per dissezione



GERALD
 18,0 cm, 7"
 16-1103-18



POTTS-SMITH
 18,0 cm, 7" **16-1026-18**
 21,0 cm, 8¹/₄" **16-1026-21**
 25,0 cm, 10" **16-1026-25**



POTTS-SMITH
 18,0 cm, 7" **16-1027-18**
 21,0 cm, 8¹/₄" **16-1027-21**
 25,0 cm, 10" **16-1027-25**



englische Modelle
 english patterns
 modelos ingleses
 modelli inglese

13,0 cm, 5" **16-1036-13**
 14,5 cm, 5³/₄" **16-1036-14**
 15,0 cm, 6" **16-1036-15**



SEMKEN
 12,5 cm, 5" **16-1040-12**
 15,0 cm, 6" **16-1040-15**



CUSHING
 17,5 cm, 6⁵/₈" **16-1092-17**



CUSHING
 17,5 cm, 6⁵/₈" **16-1093-17**



BROPHY
 20,0 cm, 8" **16-1094-20**

Anatomische Pinzetten
 Dissecting Forceps
 Pinzas de disección
 Pinze anatomiche per dissezione



BROPHY
 20,0 cm, 8"
 16-1095-20



BONNEY
 18,0 cm, 7"
 16-1120-18



SINGLE-TUTTLE
 23,0 cm, 9"
 16-1516-23



DENNIS BROWN
 20,0 cm, 8"
 16-1126-20



DUEHRSEN
 20,0 cm, 8"
 16-1470-20



WAUGH
 15,0 cm, 6" 16-1130-15
 20,0 cm, 8" 16-1130-20



RAMSEY
 18,0 cm, 7"
 16-1136-18

 1 x 2



 2 x 3



 3 x 4



 4 x 5



STANDARD

10,5 cm, 4 ¹ / ₈ "	16-1200-10
11,5 cm, 4 ¹ / ₂ "	16-1200-11
13,0 cm, 5"	16-1200-13
14,5 cm, 5 ³ / ₄ "	16-1200-14
15,0 cm, 6"	16-1200-15
16,0 cm, 6 ¹ / ₄ "	16-1200-16
18,0 cm, 7"	16-1200-18
20,0 cm, 8"	16-1200-20
25,0 cm, 10"	16-1200-25
30,0 cm, 12"	16-1200-30

11,5 cm, 4 ¹ / ₂ "	16-1252-11
13,0 cm, 5"	16-1252-13
14,5 cm, 5 ³ / ₄ "	16-1252-14
16,0 cm, 6 ¹ / ₄ "	16-1252-16
18,0 cm, 7"	16-1252-18
20,0 cm, 8"	16-1252-20
25,0 cm, 10"	16-1252-25
30,0 cm, 12"	16-1252-30

13,0 cm, 5"	16-1254-13
14,5 cm, 5 ³ / ₄ "	16-1254-14
16,0 cm, 6 ¹ / ₄ "	16-1254-16
18,0 cm, 7"	16-1254-18
20,0 cm, 8"	16-1254-20

13,0 cm, 5"	16-1256-13
14,5 cm, 5 ³ / ₄ "	16-1256-14
16,0 cm, 6 ¹ / ₄ "	16-1256-16
18,0 cm, 7"	16-1256-18
20,0 cm, 8"	16-1256-20

Chirurgische Pinzetten
Tissue Forceps
Pinzas quirúrgicas
Pinze per chirurgia

↔ 1 x 2



fein
fine
finas
fini

13,0 cm, 5"	16-1210-13
14,5 cm, 5 ³ / ₄ "	16-1210-14
15,5 cm, 6"	16-1210-15
16,0 cm, 6 ¹ / ₄ "	16-1210-16
18,0 cm, 7"	16-1210-18
20,0 cm, 8"	16-1210-20
25,0 cm, 10"	16-1210-25
30,0 cm, 12"	16-1210-30

↔ 1 x 2



mit Stift
with pin
con perno
con espiga

13,0 cm, 5"	16-1218-13
14,5 cm, 5 ³ / ₄ "	16-1218-14
15,5 cm, 6"	16-1218-15
16,0 cm, 6 ¹ / ₄ "	16-1218-16
18,0 cm, 7"	16-1218-18
20,0 cm, 8"	16-1218-20
25,0 cm, 10"	16-1218-25
30,0 cm, 12"	16-121-30

↔ 1 x 2



mit Stift
with pin
con perno
con espiga

13,0 cm, 5"	16-1219-13
14,5 cm, 5 ³ / ₄ "	16-1219-14
16,0 cm, 6 ¹ / ₄ "	16-1219-16
18,0 cm, 7"	16-1219-18
20,0 cm, 8"	16-1219-20

↔ 1 x 2



englische Modelle
english patterns
modelos ingleses
modelli inglese

13,0 cm, 5"	16-1236-13
14,5 cm, 5 ³ / ₄ "	16-1236-14
15,0 cm, 6"	16-1236-15

↔ 1 x 2



MOD. USA

12,0 cm, 4 ³ / ₄ "	16-1206-12
13,0 cm, 5"	16-1206-13
14,5 cm, 5 ³ / ₄ "	16-1206-14
15,5 cm, 6"	16-1206-15
18,0 cm, 7"	16-1206-18
20,0 cm, 8"	16-1206-20
25,0 cm, 10"	16-1206-25
30,0 cm, 12"	16-1206-30

↔ 2 x 3



MOD. USA

12,0 cm, 4 ³ / ₄ "	16-1212-12
13,0 cm, 5"	16-1212-13
14,5 cm, 5 ³ / ₄ "	16-1212-14
15,5 cm, 6"	16-1212-15
18,0 cm, 7"	16-1212-18
20,0 cm, 8"	16-1212-20
25,0 cm, 10"	16-1212-25
30,0 cm, 12"	16-1212-30

↔ 1 x 2



ADSON

12,0 cm, 4 ³ / ₄ "	16-1270-12
15,0 cm, 6"	16-1270-15

↔ 1 x 2



MICRO-ADSON

12,0 cm, 4 ³ / ₄ "	16-1276-12
15,0 cm, 6"	16-1276-15

Chirurgische Pinzetten
Tissue Forceps
Pinzas quirúrgicas
Pinze per chirurgia

 2 x 3



ADSON

12,0 cm, 4³/₄" **16-1074-12**
15,0 cm, 6" **16-1074-15**

 1 x 2



ADSON-BROWN

12,0 cm, 4³/₄" **16-1288-12**
15,0 cm, 6" **16-1288-15**



ADSON

12,0 cm, 4³/₄"
16-1282-12

 1 x 2



STILLE

15,0 cm, 6"
16-1208-15

 2 x 3



STILLE

15,0 cm, 6"
16-1209-15

 1 x 2



GILLIES

15,0 cm, 6"
16-1300-15

 2 x 3



ADLERKREUTZ

15,0 cm, 6" **16-1382-15**
20,0 cm, 8" **16-1382-20**

 4 x 5



ADLERKREUTZ

15,0 cm, 6" **16-1384-15**
20,0 cm, 8" **16-1384-20**

Chirurgische Pinzetten
Tissue Forceps
Pinzas quirúrgicas
Pinze per chirurgia

1 x 2



SEMKEN
12,5 cm, 5" **16-1240-12**
15,5 cm, 6" **16-1240-15**

2 x 3



SEMKEN
12,5 cm, 5" **16-1242-12**

1 x 2



MC INDOE
15,0 cm, 6" **16-1358-15**

1 x 2



TAYLOR
17,5 cm, 6⁵/₈" **16-1314-17**

1 x 2



TAYLOR
17,5 cm, 6⁵/₈" **16-1315-17**

1 x 2



TAYLOR
17,5 cm, 6⁵/₈" **16-1317-17**

1 x 2



GERALD
18,0 cm, 7" **16-1302-18**

1 x 2



GERALD
18,0 cm, 7" **16-1303-18**

Chirurgische Pinzetten
Tissue Forceps
Pinzas quirúrgicas
Pinze per chirurgia

1 x 2



CUSHING
17,5 cm, 6⁵/₈"
16-1292-17

1 x 2



CUSHING
17,5 cm, 6⁵/₈"
16-1293-17

1 x 2



POTTS-SMITH
18,0 cm, 7" 16-1226-18
21,0 cm, 8¹/₄" 16-1226-21
25,0 cm, 10" 16-1226-25

1 x 2



POTTS-SMITH
18,0 cm, 7" 16-1227-18
21,0 cm, 8¹/₄" 16-1227-21
25,0 cm, 10" 16-1227-25

1 x 2



WAUGH
15,0 cm, 6" 16-1330-15
20,0 cm, 8" 16-1330-20

1 x 2



BROPHY
20,0 cm, 8" 16-1294-20

x 2



BROPHY
20,0 cm, 8" 16-1295-20



RUSS. MODELL
15,0 cm, 6" 16-1456-15
20,0 cm, 8" 16-1456-20
25,0 cm, 10" 16-1456-25

Chirurgische Pinzetten
Tissue Forceps
Pinzas quirúrgicas
Pinze per chirurgia



DURINGE
14,5 cm, 5³/₄" **16-1460-14**
16,0 cm, 6¹/₄" **16-1460-16**
20,0 cm, 8" **16-1460-20**



DUEHRSSEN
20,0 cm, 8"

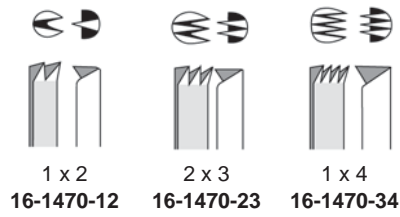

NELSON
15,0 cm, 6" **16-1518-15**
20,0 cm, 8" **16-1518-20**
23,0 cm, 9" **16-1518-23**



DUVAL
14,0 cm, 5¹/₂"

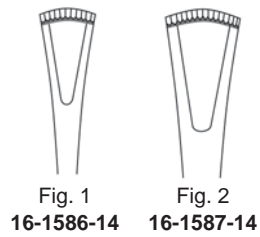

COLLIN-DUVAL
20,0 cm, 8"

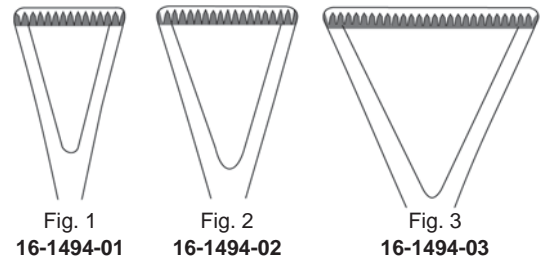

Chirurgische Pinzetten
Tissue Forceps
Pinzas quirúrgicas
Pinze per chirurgia

1 x 2

1 x 2



LANE

14,5 cm, 5³/₄" 16-1420-14
20,0 cm, 8" 16-1420-20

2 x 3



LANE

14,5 cm, 5³/₄" 16-1422-14
20,0 cm, 8" 16-1422-20

7 x 7



BROWN

15,0 cm, 6" 16-1410-15
20,0 cm, 8" 16-1410-20
25,0 cm, 10" 16-1410-25



TREVES

13,0 cm, 5" 16-1510-13
15,0 cm, 6" 16-1510-15

1 x 2



RAMSEY
18,0 cm, 7"
16-1520-18

2 x 3



RAMSEY
18,0 cm, 7"
16-1522-18

1 x 2



RAMSEY
18,0 cm, 7"
16-1590-18

2 x 3



RAMSEY
18,0 cm, 7"
16-1592-18

**Splitterpinzetten
Splinter Forceps
Pinzas para espinas
Pinze per schegge**

1 x 2



8,0 cm, 3¹/₄" **16-1662-08**
 9,0 cm, 3¹/₂" **16-1662-09**
 10,5 cm, 4¹/₈" **16-1662-10**
 11,5 cm, 4¹/₂" **16-1662-11**
 13,0 cm, 5" **16-1662-13**
 14,5 cm, 5¹/₂" **16-1662-14**

8,0 cm, 3¹/₄" **16-1663-08**
 9,0 cm, 3¹/₂" **16-1663-09**
 10,5 cm, 4¹/₈" **16-1663-10**
 11,5 cm, 4¹/₂" **16-1663-11**
 13,0 cm, 5" **16-1663-13**
 14,5 cm, 5¹/₂" **16-1663-14**

8,0 cm, 3¹/₄" **16-1666-08**
 9,0 cm, 3¹/₂" **16-1666-09**
 10,5 cm, 4¹/₈" **16-1666-10**
 11,5 cm, 4¹/₂" **16-1666-11**
 13,0 cm, 5" **16-1666-13**
 14,5 cm, 5¹/₂" **16-1666-14**

8,0 cm, 3¹/₄" **16-1667-08**
 9,0 cm, 3¹/₂" **16-1667-09**
 10,5 cm, 4¹/₈" **16-1667-10**
 11,5 cm, 4¹/₂" **16-1667-11**
 13,0 cm, 5" **16-1667-13**
 14,5 cm, 5¹/₂" **16-1667-14**

Splitterpinzetten, Mikro-Pinzetten
 Splinter Forceps, Micro Forceps
 Pinzas para espinas, Pinzas para microscopia
 Pinze per schegge, Pinze per microscopia



HUNTER
 10,5 cm, 4¹/₄"
 16-1652-10



HUNTER
 10,5 cm, 4¹/₄"
 16-1653-10



WALTER-CARMALT
 10,5 cm, 4¹/₄"
 16-1656-10



WALTER-CARMALT
 10,5 cm, 4¹/₄"
 16-1657-10



FEILCHENFELD
 7,5 cm, 3¹/₈" 16-1650-07
 9,0 cm, 3¹/₂" 16-1650-09
 11,5 cm, 4¹/₂" 16-1650-11



10,0 cm, 4"
 16-1806-10



10,0 cm, 4"
 16-1807-10



10,0 cm, 4"
 16-1809-10

Mikro-Pinzetten
Micro Forceps
Pinzas para microscopia
Pinze per microscopia



GRAEFE
10,0 cm, 4"
16-1810-10



GRAEFE
10,0 cm, 4"
16-1811-10



GRAEFE
10,0 cm, 4"
16-1813-10



GRAEFE
10,0 cm, 4"
16-1814-10



GRAEFE
10,0 cm, 4"
16-1815-10



GRAEFE
10,0 cm, 4"
16-1817-10

Uhrmacher Pinzetten, Gefäßdilatoren
 Jeweller's Forceps, Vessel Dilators
 Pinzas de relojería, Dilatadores vasculares
 Pinze per orologiaio, Dilatatori vascolari



Fig. 3
 11,5 cm, 4 1/2"
 16-1601-03



Fig. 4
 11,5 cm, 4 1/2"
 16-1601-04



Fig. 5
 11,5 cm, 4 1/2"
 16-1601-05



Fig. 7
 11,5 cm, 4 1/2"
 16-1601-07

0,3 mm x 45°



11,0 cm, 4 3/8"
 16-1620-01

0,3 mm x 90°



11,0 cm, 4 3/8"
 16-1620-02

0,3 mm



11,0 cm, 4 3/8"
 16-1620-03

0,3 mm x 45°



11,0 cm, 4 3/8"
 16-1620-04

diamantbeschichtet
 diamond coated
 diamantato
 diamantato

Gefäßdilatoren, Atraumatische Pinzetten
 Vessel Dilators, Atraumatic Forceps
 Dilatadores vasculares, Pinzas atraumáticas
 Dilatatori vascolari, Pinze anatomiche atraumatica

0,3 mm



9 mm

12,0 cm, 4³/₄"
 16-1634-12

0,3 mm



9 mm

13,5 cm, 5³/₈"
 16-1634-13

0,4 mm



9 mm

13,5 cm, 5³/₈"
 16-1635-13

0,3 mm x 45°



9 mm

13,5 cm, 5³/₈"
 16-1637-13



1,5 mm



2,0 mm



2,4 mm



2,8 mm



16,0 cm, 6 ¹ / ₄ "	16-1700-16	16-1702-16	16-1704-16	16-1706-16
20,0 cm, 8"	16-1700-20	16-1702-20	16-1704-20	16-1706-20
24,0 cm, 9 ¹ / ₂ "	16-1700-24	16-1702-24	16-1704-24	16-1706-24
30,0 cm, 12"	16-1700-30	16-1702-30	16-1704-30	16-1706-30

2,8 mm



3,5 mm



3,5 mm



16,0 cm, 6 ¹ / ₄ "	16-1716-16	16-1708-16	16-1718-16
20,0 cm, 8"	16-1716-20	16-1708-20	16-1718-20
24,0 cm, 9 ¹ / ₂ "	16-1716-24	16-1708-24	16-1718-24
30,0 cm, 12"	16-1716-30	16-1708-30	16-1718-30



1,5 mm



2,0 mm



16,0 cm, 6 ¹ / ₄ "	16-1701-16	16-1703-16
20,0 cm, 8"	16-1701-20	16-1703-20
24,0 cm, 9 ¹ / ₂ "	16-1701-24	16-1703-24
30,0 cm, 12"	16-1701-30	16-1703-30

DE BAKEY

DE BAKEY

Pinzetten mit Hartmetalleinlagen
 Forceps with tungsten carbide inserts
 Pinzas con bocas de carburo tungsteno
 Pinze con morsi in carburo di tungsteno



STANDARD

14,5 cm, 5 ³ / ₄ "	17-1200-14
16,0 cm, 6 ¹ / ₄ "	17-1200-16
18,0 cm, 7"	17-1200-18
20,0 cm, 8"	17-1200-20
25,0 cm, 10"	17-1200-25
30,0 cm, 12"	17-1200-30



STANDARD

14,0 cm, 5 ¹ / ₂ "	17-1208-14
16,0 cm, 6 ¹ / ₄ "	17-1208-16
18,0 cm, 7"	17-1208-18
20,0 cm, 8"	17-1208-20
25,0 cm, 10"	17-1208-25
30,0 cm, 12"	17-1208-30



STANDARD

12,5 cm, 5"	17-1040-12
15,0 cm, 6"	17-1040-15



STANDARD

15,0 cm, 6"	17-1140-15
23,0 cm, 9"	17-1140-23
25,0 cm, 10"	17-1140-25

Pinzetten mit Hartmetalleinlagen
 Forceps with tungsten carbide inserts
 Pinzas con bocas de carburo tungsteno
 Pinze con morsi in carburo di tungsteno



GILLIES
 15,0 cm, 6"
 17-1300-15



MC INDOE
 15,0 cm, 6"
 17-1158-15



17-1102-17



17-1302-17



POTTS-SMITH
 15,0 cm, 6" 17-1026-15
 18,0 cm, 7" 17-1026-18
 20,0 cm, 8" 17-1026-20



BONNEY
 17,5 cm, 6⁵/₈"
 17-1590-17



17-1092-17

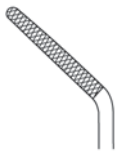

17-1093-17

CUSHING
 17,5 cm, 6⁵/₈"



CUSHING-TAYLOR
 18,0 cm, 7"
 17-1117-18

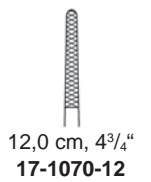

12,0 cm, 4³/₄"
 17-1070-12

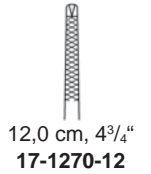

12,0 cm, 4³/₄"
 17-1270-12

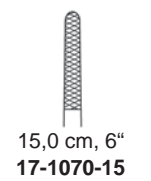

15,0 cm, 6"
 17-1070-15

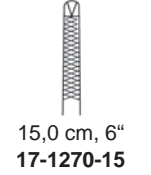

15,0 cm, 6"
 17-1270-15

ADSON
 17,5 cm, 6⁵/₈"

Tuch-, Schlauchklemmen, Tupferzangen

Towel Clamps, Sponge and Dressing Forceps, Tubing Clamps

Pinzas de campo, Pinzas para vendajes y torundas y para tubos

Pinze per fissare le compresse, per medicatura e tamponi, e per tubi



Tuchklemmen
Towel Clamps
Pinzas de campo
Pinze per fissare le compresse



SCHAEDEL
9,0 cm, 3 1/2"
22-1101-09



ENGL. MODELL
9,0 cm, 3 1/2"
22-1109-09



JONES
5,0 cm, 2" 22-1105-05
7,0 cm, 2 3/4" 22-1105-07
9,0 cm, 3 1/2" 22-1105-09



JONES
9,0 cm, 3 1/2"
22-1107-09

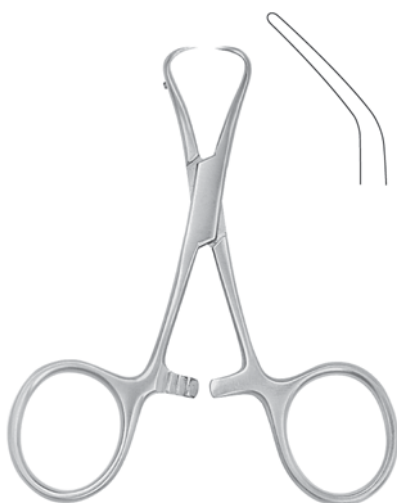

BACKHAUS
9,0 cm, 3 1/2" 22-1000-09
11,0 cm, 4 3/8" 22-1000-11
13,0 cm, 5" 22-1000-13
15,0 cm, 6" 22-1000-15



mit Schlauch- oder Kabelhalter
with clip for tubing or cable
con porta-tubo o porta-cable
con porta-tubo o porta-cavo

11,0 cm, 4 3/8"
22-1005-11



ROEDER
13,0 cm, 5"
22-1010-13

Tuchklemmen
Towel Clamps
Pinzas de campo
Pinze per fissare le compresse



ROEDER
15,0 cm, 5"
22-1010-15



BERNHARD
16,5 cm, 6 1/2"
22-1044-16

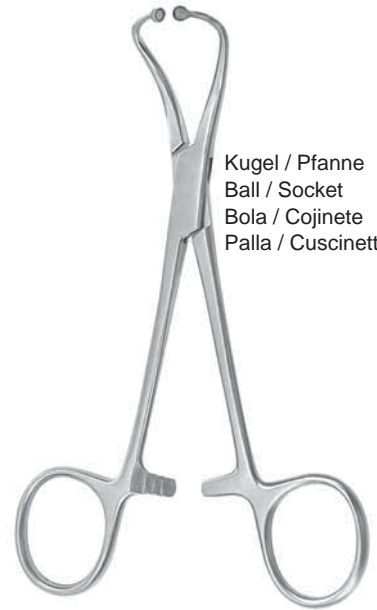

Kugel / Pfanne
Ball / Socket
Bola / Cojinete
Palla / Cuscinetto

13,0 cm, 5"
22-1024-13

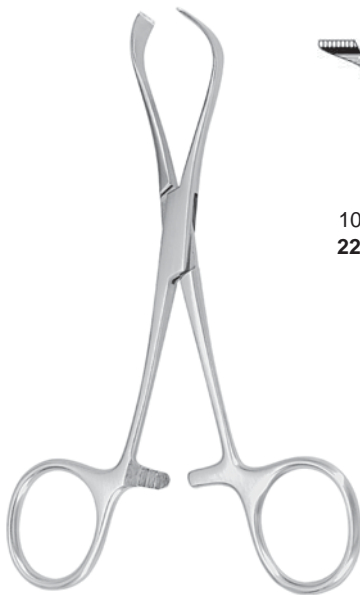

LORNA



10,0 cm, 4"
22-1014-10



13,0 cm, 5"
22-1014-13



LANE
15,0 cm, 6" 22-1040-15
18,0 cm, 7" 22-1040-18
20,0 cm, 8" 22-1040-20

Tuchklemmen, Korn- und Tupferzangen
 Towel Clamps, Sponge and Dressing Forceps
 Pinzas de campo, Pinzas para vendajes y torundas
 Pinze per fissare le compresse, Pinze per medicatura e tamponi



TOHOKU



10,0 cm, 4"
 22-1020-10



13,0 cm, 5"
 22-1020-13



PEERS
 14,5 cm, 5³/₄"
 22-1030-14



LISTER
 13,0 cm, 5" 22-1360-13
 16,0 cm, 6¹/₄" 22-1360-16
 18,0 cm, 7" 22-1360-18



BRYANT
 13,0 cm, 5"
 22-1351-13

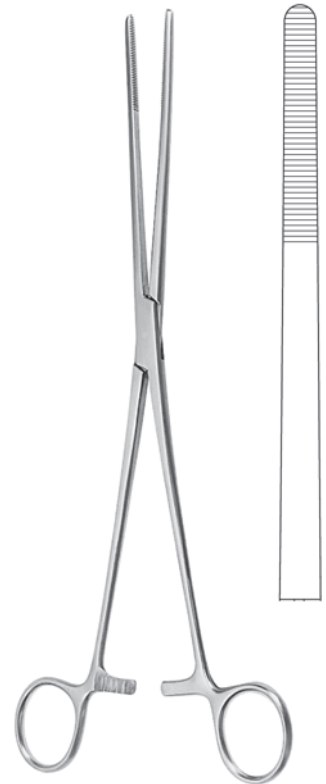

BOZEMANN
 26,0 cm, 10¹/₄"
 22-1320-26

Korn- und Tupferzangen
Sponge and Dressing Forceps
Pinzas para vendajes y torundas
Pinze per medicatura e tamponi

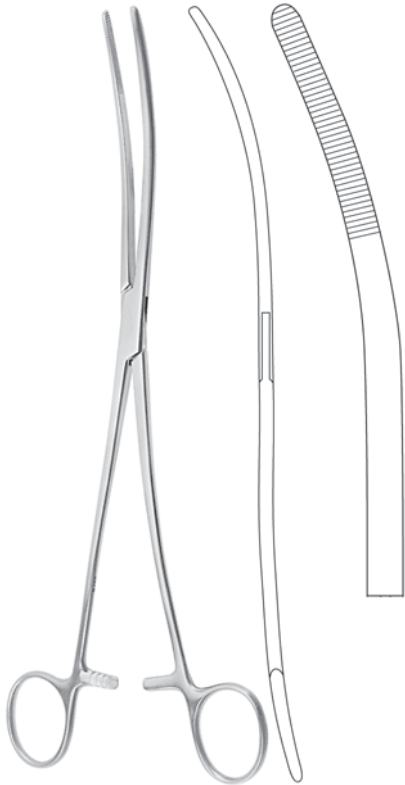

BOZEMANN
 26,0 cm, 10¹/₄"
 22-1321-26



COLLIN
 25,0 cm, 9³/₄"
 22-1300-25



CHERON
 25,0 cm, 9³/₄"
 22-1303-25



PELKMANN
 25,0 cm, 9³/₄"

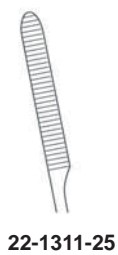

ULRICH

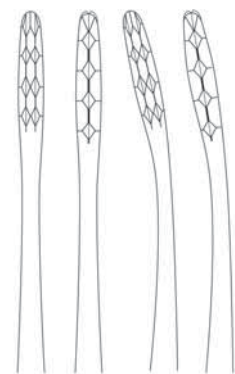

22,0 cm, 8⁵/₈" 22-1200-22 22-1201-22
 25,0 cm, 9³/₄" 22-1200-25 22-1201-25
 27,0 cm, 10⁵/₈" 22-1200-27 22-1201-27

Korn- und Tupferzangen
Sponge and Dressing Forceps
Pinzas para vendajes y torundas
Pinze per medicatura e tamponi



20,0 cm, 8"	22-1210-20	22-1211-20
22,0 cm, 8 ⁵ / ₈ "	22-1210-22	22-1211-22
25,0 cm, 9 ³ / ₄ "	22-1210-25	22-1211-25
27,0 cm, 10 ⁵ / ₈ "	22-1210-27	22-1211-27

GROSS-MAIER



25,0 cm, 9 ³ / ₄ "	22-1180-25
--	-------------------

25,0 cm, 9 ³ / ₄ "	22-1181-25
--	-------------------

FOERSTER



18,0 cm, 7"	22-1160-18	22-1161-18	22-1170-18	22-1171-18
20,0 cm, 8"	22-1160-20	22-1161-20	22-1170-20	22-1171-20
25,0 cm, 9 ³ / ₄ "	22-1160-25	22-1161-25	22-1170-25	22-1171-25

FOERSTER-BALLENGER



RAMPLEY	
18,0 cm, 7"	22-1190-18
25,0 cm, 9 ³ / ₄ "	22-1190-25

Schlauchklemmen
Tubing Clamps
Pinzas para tubos
Pinze per tubi



PRESBYTERIAN

16,5 cm, 6 ¹ / ₂ "	23-1012-16
18,0 cm, 7"	23-1012-18
20,0 cm, 8"	23-1012-20

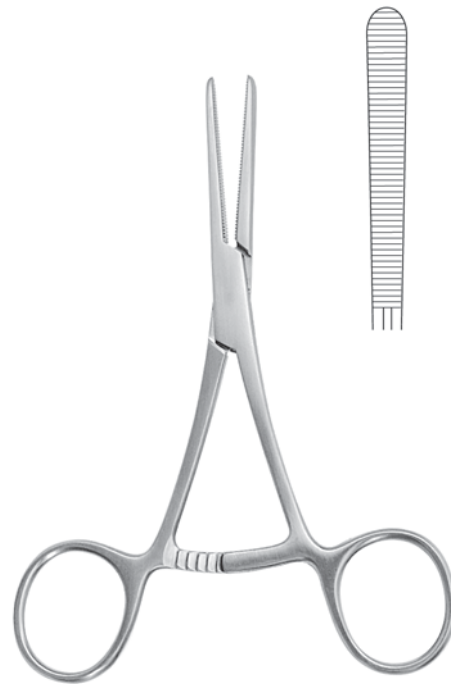

BERLIN

14,5 cm, 5³/₄"
23-1006-14

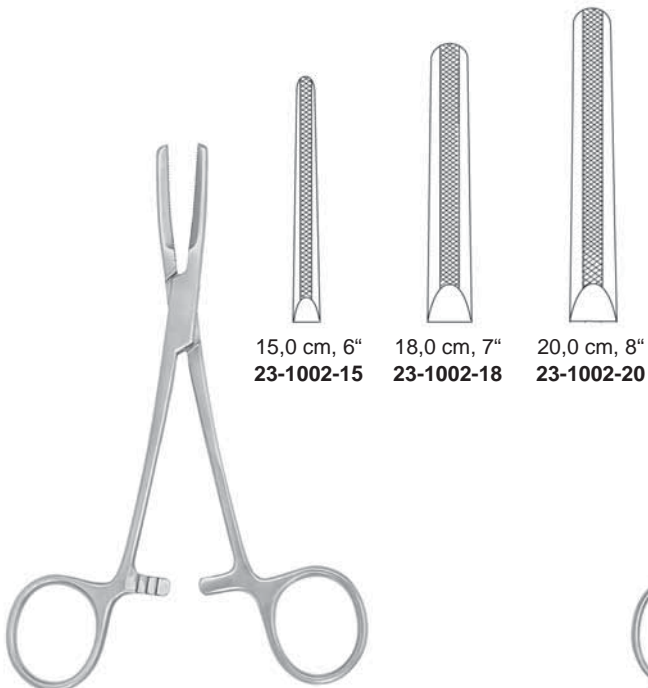

15,0 cm, 6"
23-1002-15

18,0 cm, 7"
23-1002-18

20,0 cm, 8"
23-1002-20

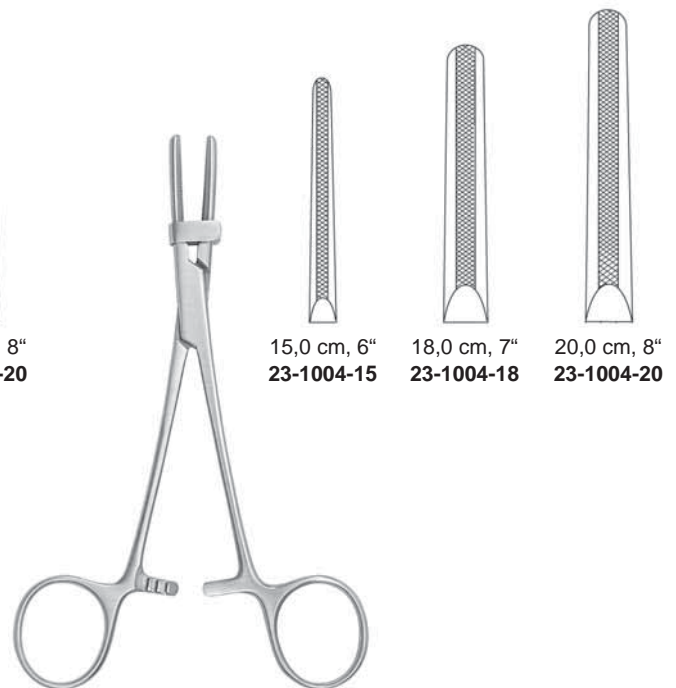

15,0 cm, 6"
23-1004-15

18,0 cm, 7"
23-1004-18

20,0 cm, 8"
23-1004-20

Klemmen
Forceps
Pinas
Pinze



Bulldogklemmen
Bulldog Clamps
Clamps Bulldog
Pinze Bulldog



3,5 cm, 1 1/2"	20-1014-03	20-1015-03
5,0 cm, 2"	20-1014-05	20-1015-05



DIEFFENBACH



HESS
20-1520-01



HESS
20-1520-02



3,8 cm, 1 1/2"	20-1018-04	20-1019-04
5,0 cm, 2"	20-1018-05	20-1019-05
6,3 cm, 2 1/2"	20-1018-06	20-1019-06
7,6 cm, 3"	20-1018-07	20-1019-07
9,0 cm, 3 1/2"	20-1018-09	20-1019-09

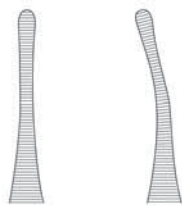

JOHNS-HOPKINS



JOHNS-HOPKINS
23,0 cm, 9"
20-1295-23



mit atraumatischer Riefung
 with non-traumatic serration
 con bocas atraumáticas
 con presa atraumatica

		L
7,5 cm, 3"	20-1292-07	2,5 cm, 1"
8,5 cm, 3 ¹ / ₄ "	20-1292-08	3,5 cm, 1 ³ / ₈ "
10,5 cm, 4 ¹ / ₈ "	20-1292-10	5,0 cm, 2"
12,0 cm, 4 ³ / ₄ "	20-1292-12	6,8 cm, 2 ³ / ₄ "

DE BAKEY



mit atraumatischer Riefung
 with non-traumatic serration
 con bocas atraumáticas
 con presa atraumatica

		L
7,0 cm, 2 ³ / ₄ "	20-1293-07	2,5 cm, 1"
8,0 cm, 3 ¹ / ₈ "	20-1293-08	3,5 cm, 1 ³ / ₈ "
10,0 cm, 3 ³ / ₄ "	20-1293-10	5,0 cm, 2"
11,5 cm, 4 ¹ / ₂ "	20-1293-12	6,8 cm, 2 ³ / ₄ "

DE BAKEY



TITANIUM
 3,5 cm, 1³/₈"
 vena **21-1032-35**
 arteria **21-1042-35**



TITANIUM
 3,5 cm, 1³/₈"
 vena **21-1033-35**
 arteria **21-1043-35**



TITANIUM
 4,0 cm, 1⁵/₈"
 vena **21-1032-40**
 arteria **21-1042-40**



TITANIUM
 4,0 cm, 1⁵/₈"
 vena **21-1033-40**
 arteria **21-1043-40**

Bulldogklemmen, Darm- und Gewebefaßzangen
Bulldog Clamps, Intestinal and Tissue Grasping Forceps
Clamps Bulldog, Pinzas intestinales y para tejidos
Pinze Bulldog, Pinze da presa per intestino e tessuti

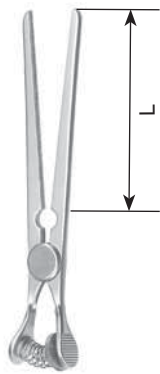

		L	
6,8 cm, 2 ³ / ₄ "	20-1298-07	3,3 cm, 1 ³ / ₈ "	
9,6 cm, 3 ³ / ₄ "	20-1298-09	5,0 cm, 2"	
11,7 cm, 4 ³ / ₄ "	20-1298-11	6,9 cm, 2 ³ / ₄ "	

GLOVER

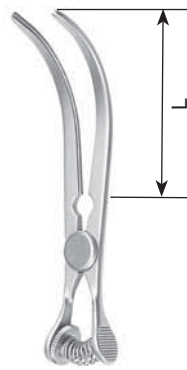

		L	
6,5 cm, 2 ¹ / ₂ "	20-1299-06	3,3 cm, 1 ³ / ₈ "	
9,1 cm, 3 ¹ / ₂ "	20-1299-09	5,0 cm, 2"	
11,0 cm, 4 ³ / ₈ "	20-1299-11	6,9 cm, 2 ³ / ₄ "	

GLOVER



CHAPUT
 13,0 cm, 5"
 24-1370-13



TUFFIER
 13,0 cm, 5"
 24-1372-13



COLLIN
 16,0 cm, 6¹/₄"
 24-1376-16

Darm- und Gewebefaßzangen
 Intestinal and Tissue Grasping Forceps
 Pinzas intestinales y para tejidos
 Pinze da presa per intestino e tessuti



PENNINGTON

15,5 cm, 6" **24-1358-15**
 20,0 cm, 8" **24-1358-20**



ATRAUMA



25,0 cm, 9³/₄"
24-1658-25



27,0 cm, 10¹/₂"
24-1658-27

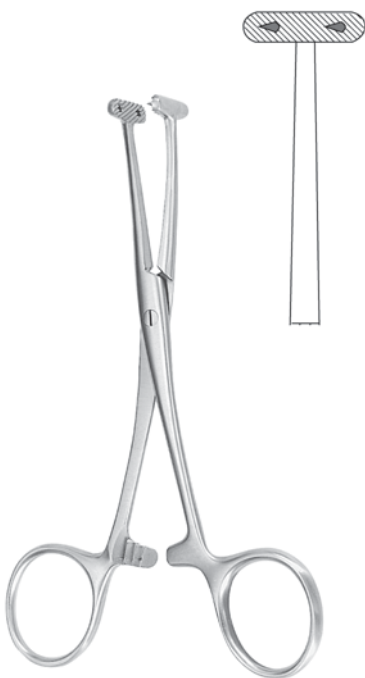

MARTEL

14,0 cm, 5¹/₂"
24-1364-14

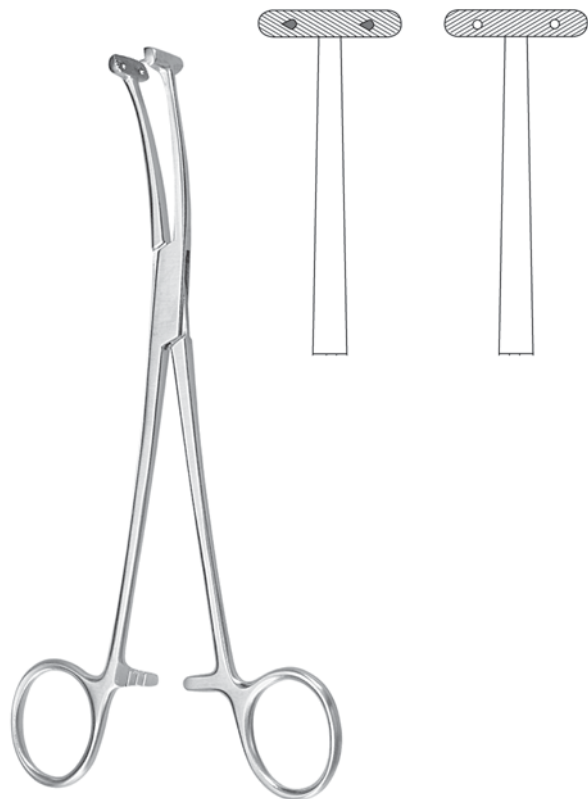

WILLET-MARTEL

19,0 cm, 7¹/₂"
24-1366-19

Arterienklemmen
 Haemostatic Forceps
 Pinzas hemostáticas
 Pinze emostatiche



PRATT
 15,0 cm, 6"
 24-1656-15



FERGUSSON

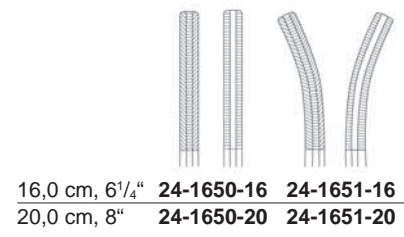

CARREL
 10,0 cm, 4"
 24-1010-10



TERRIER
 10,0 cm, 4"
 24-1016-10



KROENLEIN
 13,0 cm, 5"
 24-1369-13

Arterienklemmen
Haemostatic Forceps
Pinzas hemostáticas
Pinze emostatiche



PEAN

14,0 cm, 5½" **24-1368-14**
16,0 cm, 6¼" **24-1368-16**

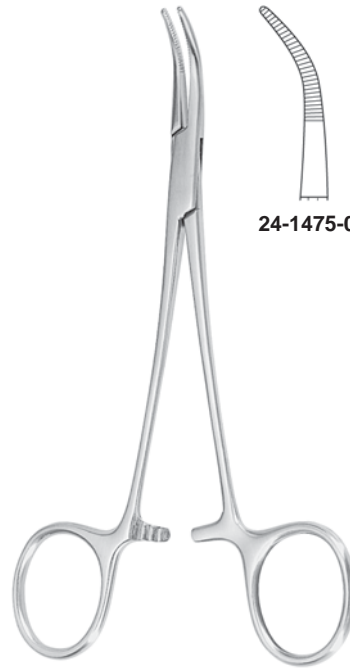

24-1475-01

24-1475-02

BABY-MIXTER

14,0 cm, 5½"



13,0 cm, 5"	24-1290-13	24-1291-13
15,0 cm, 6"	24-1290-15	24-1291-15
18,0 cm, 7"	24-1290-18	24-1291-18
20,0 cm, 8"	24-1290-20	24-1291-20

SPENCER-WELLS



24-1000-10

24-1001-10

HARTMANN

10,0 cm, 4"

Arterienklemmen
 Haemostatic Forceps
 Pinzas hemostáticas
 Pinze emostatiche

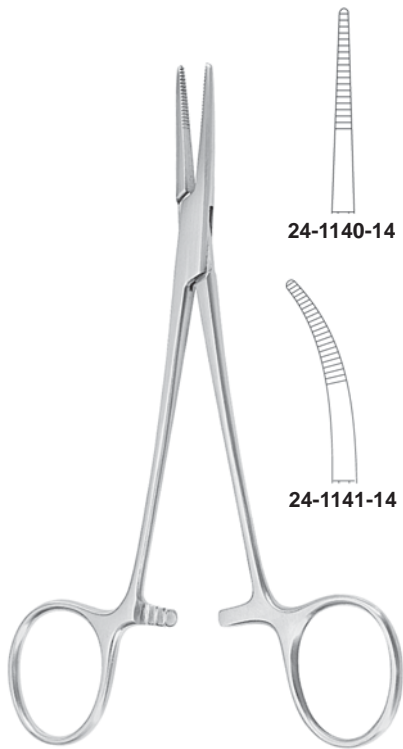

PROVICENCE-HOSPITAL
 14,0 cm, 5½"



HALSTED-MOSQUITO

12,5 cm, 5"	24-1050-12	24-1051-12
14,0 cm, 9¾"	24-1050-14	24-1051-14
	1 x 2	1 x 2
12,5 cm, 5"	24-1070-12	24-1071-12
14,0 cm, 9¾"	24-1070-14	24-1071-14



HALSTED-MOSQUITO

18,0 cm, 7"	18,0 cm, 7"	21,0 cm, 8¼"	21,0 cm, 8¼"
24-1050-18	24-1051-18	24-1050-21	24-1051-21
1 x 2	1 x 2	1 x 2	1 x 2
18,0 cm, 7"	18,0 cm, 7"	21,0 cm, 8¼"	21,0 cm, 8¼"
24-1070-18	24-1071-18	24-1070-21	24-1071-21

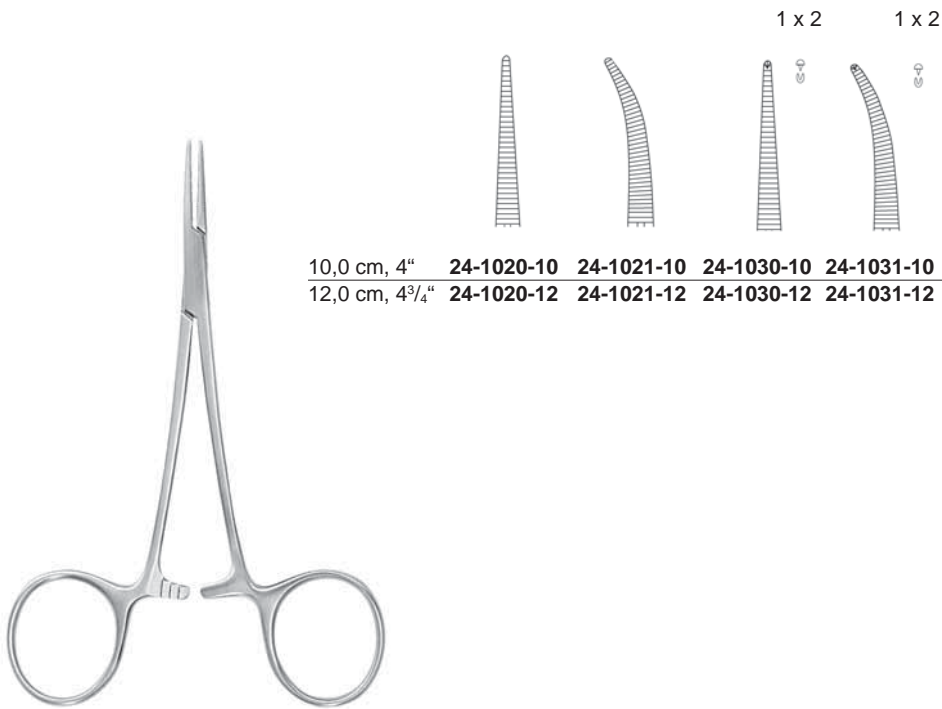

10,0 cm, 4"	24-1020-10	24-1021-10	24-1030-10	24-1031-10
12,0 cm, 4 ³ / ₄ "	24-1020-12	24-1021-12	24-1030-12	24-1031-12

MICRO-MOSQUITO

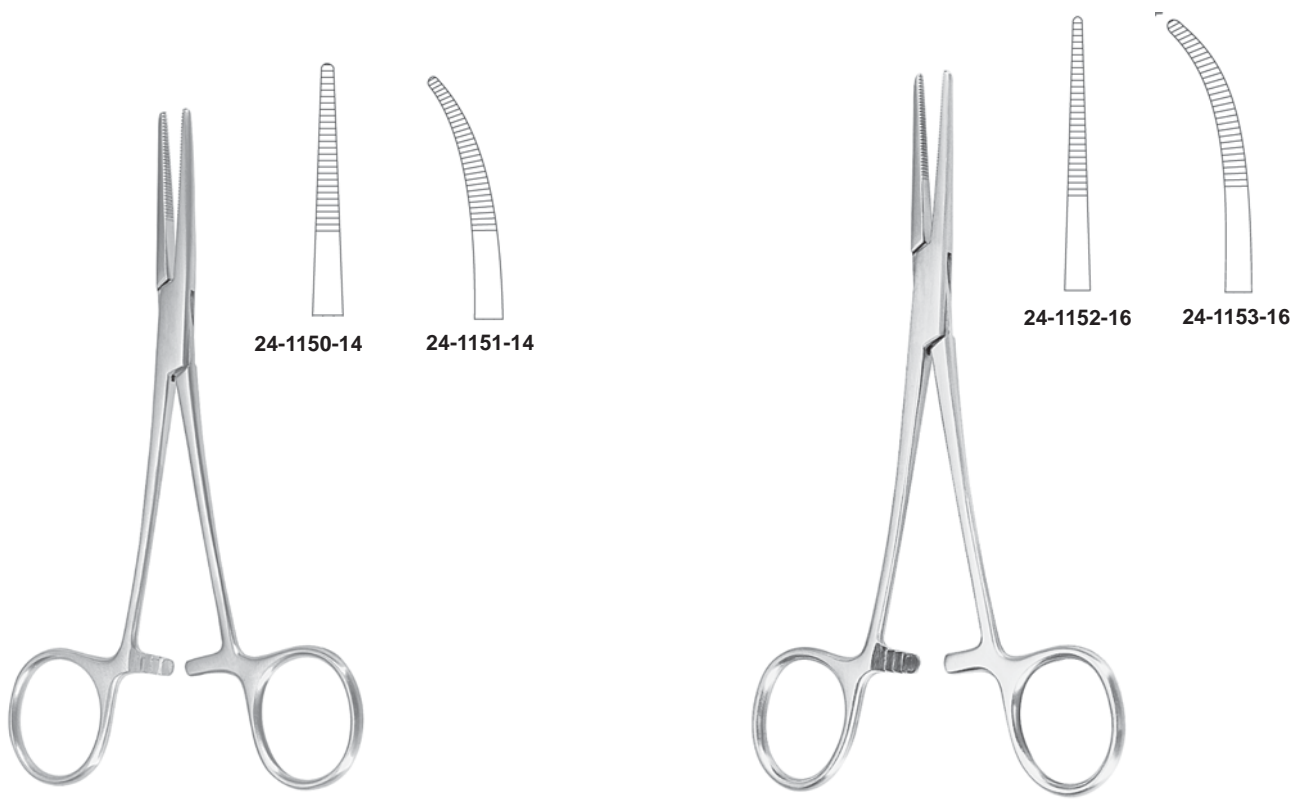

KELLY
 14,0 cm, 5¹/₂"

KELLY-RANKIN
 16,0 cm, 6¹/₄"

Arterienklemmen
 Haemostatic Forceps
 Pinzas hemostáticas
 Pinze emostatiche



LERICHE
 15,0 cm, 6"



24-1380-15



24-1381-15

1 x 2



24-1382-15

1 x 2



24-1383-15



BABY-OVERHOLT
 13,5 cm, 5 1/4"
 24-1424-14

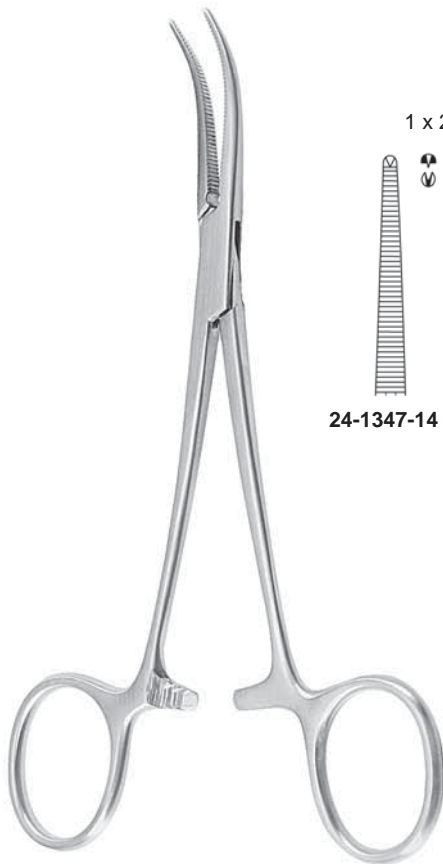

DANDY
 14,0 cm, 5 1/2"

1 x 2



24-1347-14



CRILE
 14,0 cm, 5 1/2"



24-1160-14



24-1161-14

1 x 2



24-1170-14

1 x 2



24-1171-14

Arterienklemmen
Haemostatic Forceps
inzas hemostáticas
Pinze emostatiche

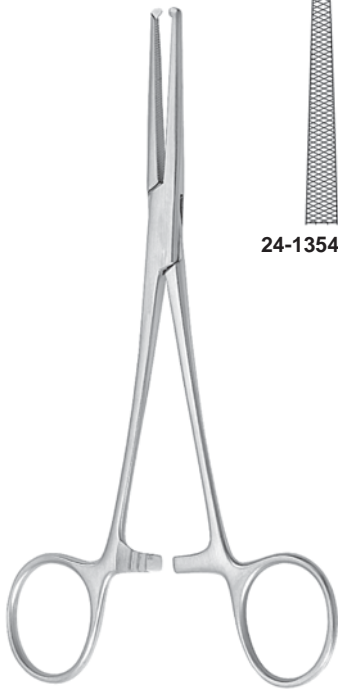

24-1354-15

DIXON-LOVELACE
15,0 cm, 6"

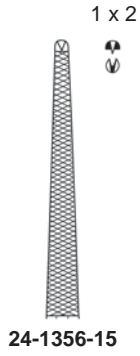

24-1540-19

BIRKETT
19,0 cm, 7 1/2"



CRILE-RANKIN
16,0 cm, 6 1/4"

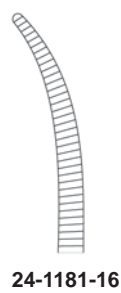
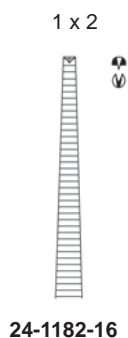
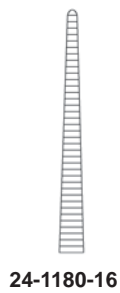

Arterienklemmen
 Haemostatic Forceps
 Pinzas hemostáticas
 Pinze emostatiche



24-1187-19



24-1185-19

SCHNIDT
 19,0 cm, 7 1/2"



24-1183-19



24-1181-19

SCHNIDT-SAWTELL
 19,0 cm, 7 1/2"



24-1414-16



24-1415-18

1 x 2



24-1412-18

1 x 2



24-1413-18

ADSON
 18,5 cm, 7 1/4"

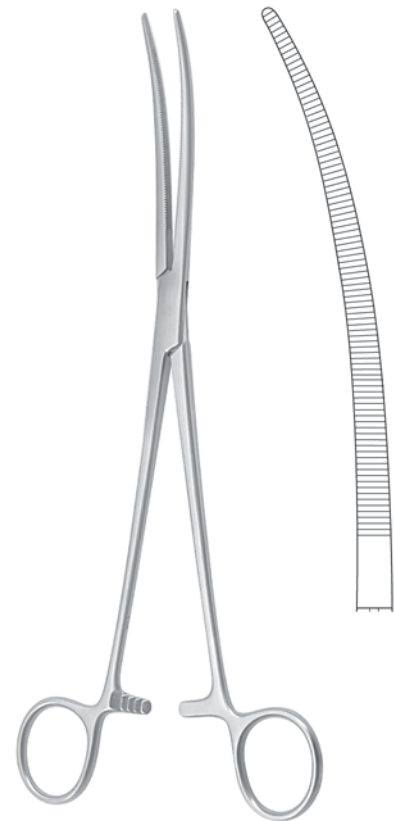

CRAFOORD
 24,0 cm, 9 1/2"
 24-1453-24

Arterienklemmen
Haemostatic Forceps
Pinzas hemostáticas
Pinze emostatiche



15,0 cm, 6" 24-1480-15 24-1481-15
18,5 cm, 7 1/4" 24-1480-18 24-1481-18

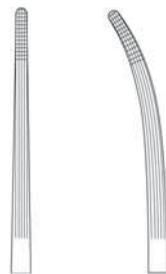

BAINBRIDGE



16,0 cm, 6 1/4" 24-1340-16 24-1341-16
20,0 cm, 8" 24-1340-20 24-1341-20

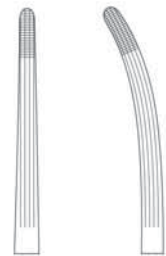

ROCHESTER-CARMALT



13,0 cm, 5" 24-1262-13 24-1263-13
14,0 cm, 5 1/2" 24-1262-14 24-1263-14
16,0 cm, 6 1/4" 24-1262-16 24-1263-16

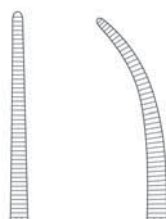

PEAN DELICATE



13,0 cm, 5" 24-1352-13 24-1353-13
14,0 cm, 5 1/2" 24-1352-14 24-1353-14
16,0 cm, 6 1/4" 24-1352-16 24-1353-16

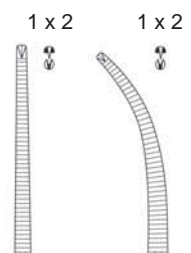

KOCHER DELICATE

Arterienklemmen
 Haemostatic Forceps
 Pinzas hemostáticas
 Pinze emostatiche



14,0 cm, 5½"	24-1260-14	24-1261-14
16,0 cm, 6¼"	24-1260-16	24-1261-16
18,0 cm, 7"	24-1260-18	24-1261-18
20,0 cm, 8"	24-1260-20	24-1261-20
22,0 cm, 8⅝"	24-1260-22	24-1261-22
24,0 cm, 9½"	24-1260-24	24-1261-24
26,0 cm, 10¼"	24-1260-26	24-1261-26
30,0 cm, 12"	24-1260-30	24-1261-30

ROCHESTER-PEAN

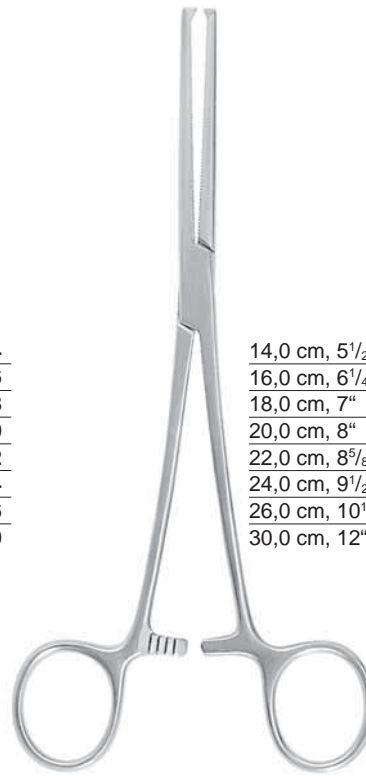

14,0 cm, 5½"	24-1350-14	24-1351-14
16,0 cm, 6¼"	24-1350-16	24-1351-16
18,0 cm, 7"	24-1350-18	24-1351-18
20,0 cm, 8"	24-1350-20	24-1351-20
22,0 cm, 8⅝"	24-1350-22	24-1351-22
24,0 cm, 9½"	24-1350-24	24-1351-24
26,0 cm, 10¼"	24-1350-26	24-1351-26
30,0 cm, 12"	24-1350-30	24-1351-30

KOCHER-OCHSNER



20,0 cm, 8"	24-1384-20	24-1385-20	24-1386-20	24-1387-20
26,0 cm, 10¼"	24-1384-26	24-1385-26	24-1386-26	24-1387-26

BENGOLEA

Arterienklemmen
Haemostatic Forceps
Pinzas hemostáticas
Pinze emostatiche

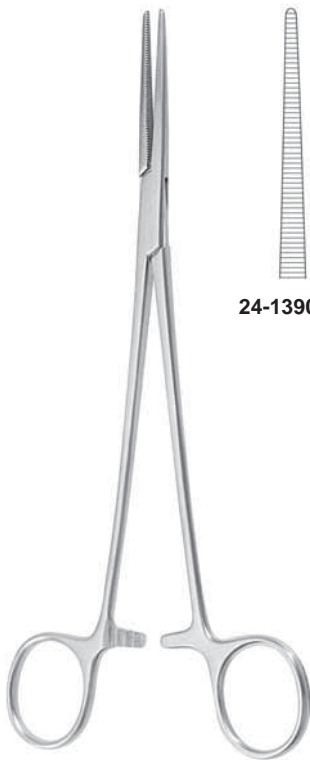

24-1390-20

24-1391-20

24-1393-20

HEISS
20,0 cm, 8"



24-1448-22

24-1449-22

ROBERTS
22,0 cm, 8⁵/₈"



24-1450-24

24-1451-24

SAROT
24,0 cm, 9¹/₂"



24-1533-01

24-1533-02

NEGUS
19,0 cm, 7¹/₂"

Präparier- und Ligaturklemmen
Dissecting and Ligature Forceps
Pinzas de disección y ligaduras
Pinze per preparazioni e legature



14,0 cm, 5½"
24-1411-14



18,0 cm, 7"
24-1411-18



MICRO-ADSON
 14,0 cm, 5½"
24-1409-14



BABY-MIXTER
 18,0 cm, 7"
24-1475-18



OVERHOLT-MIXTER
 21,0 cm, 8¼"
24-1471-21



JOHNS HOPKINS
 20,0 cm, 8"
24-1497-20

Präparier- und Ligaturklemmen
 Dissecting and Ligature Forceps
 Pinzas de disección y ligaduras
 Pinze per preparazioni e legature



OVERHOLT

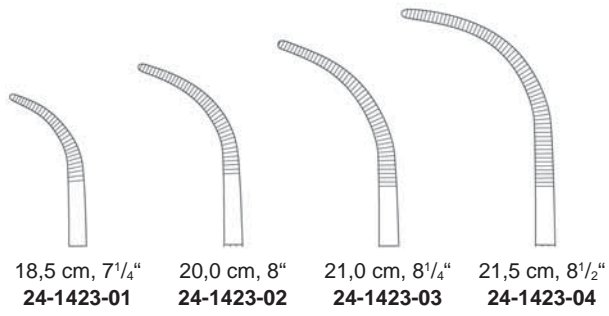

RUMEL
 23,0 cm, 9"

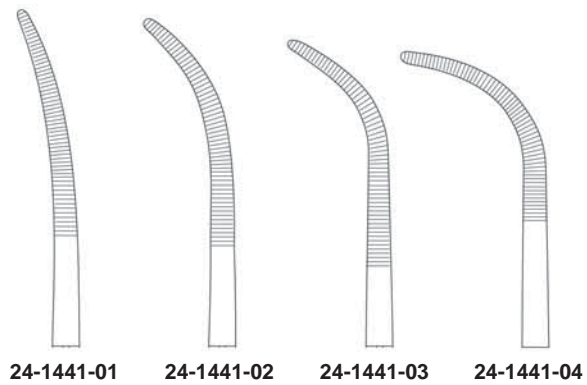

Präparier- und Ligaturklemmen
Dissecting and Ligature Forceps
Pinzas de disección y ligaduras
Pinze per preparazioni e legature



OVERHOLT-GEISSENDOERFER

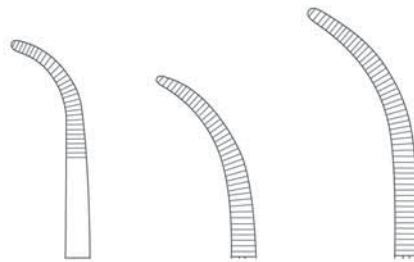

24-1421-01 20,5 cm, 7³/₄"
24-1421-02 20,0 cm, 7¹/₂"
24-1421-03 21,5 cm, 8¹/₄"

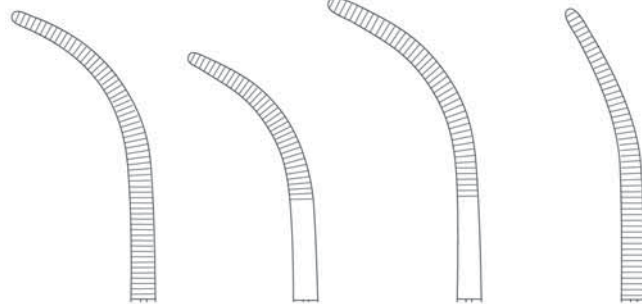

24-1421-04 22,0 cm, 8³/₄"
24-1421-05 21,5 cm, 8¹/₂"
24-1421-06 22,0 cm, 8³/₄"
24-1421-07 22,0 cm, 8³/₄"

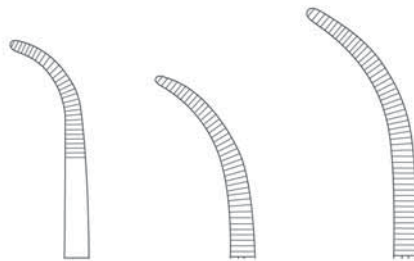

24-1422-01 27,0 cm, 10³/₄"
24-1422-02 26,0 cm, 10¹/₄"
24-1422-03 27,0 cm, 10³/₄"

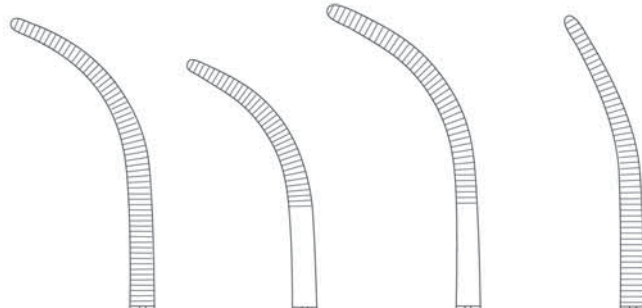

24-1422-04 27,5 cm, 10³/₄"
24-1422-05 27,5 cm, 10³/₄"
24-1422-06 28,0 cm, 11"
24-1422-07 28,0 cm, 11"

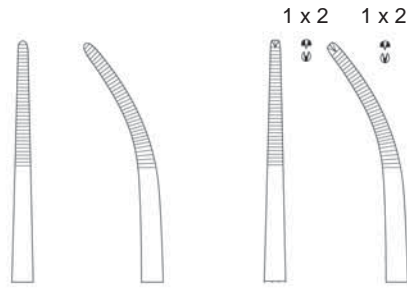

21,0 cm, 8 ¹ / ₄ "	24-1442-21	24-1443-21	24-1444-21	24-1445-21
26,0 cm, 10 ¹ / ₄ "	24-1442-26	24-1443-26	24-1444-26	24-1445-26

TOENNIS

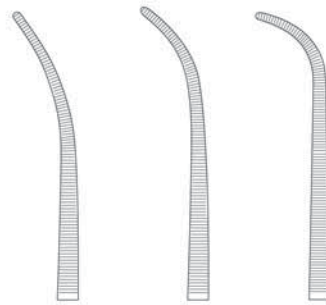

19,0 cm, 7 ¹ / ₂ "	24-1463-19	24-1465-19	24-1467-19
22,0 cm, 8 ⁵ / ₈ "	24-1463-22	24-1465-22	24-1467-22
24,0 cm, 9 ¹ / ₂ "	24-1463-24	24-1465-24	24-1467-24

KELLY

Präparier- und Ligaturklemmen
Dissecting and Ligature Forceps
Pinzas de disección y ligaduras
Pinze per preparazioni e legature



18,0 cm, 7"	24-1429-18
22,0 cm, 8 ⁵ / ₈ "	24-1429-22
25,0 cm, 9 ³ / ₄ "	24-1429-25
28,0 cm, 11"	24-1429-28

MINI-GEMINI

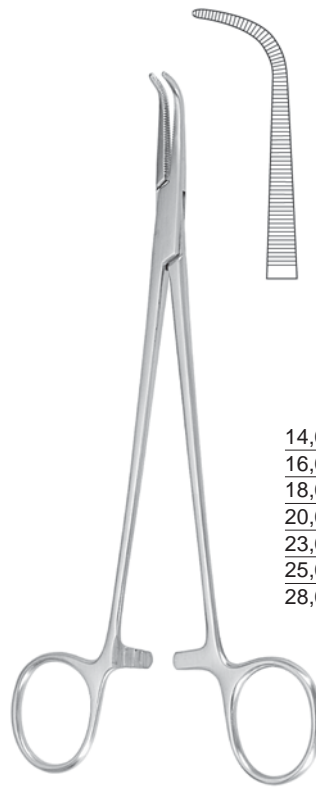

14,0 cm, 5 ¹ / ₂ "	24-1431-14
16,0 cm, 6 ¹ / ₄ "	24-1431-16
18,0 cm, 7"	24-1431-18
20,0 cm, 8"	24-1431-20
23,0 cm, 9"	24-1431-23
25,0 cm, 9 ³ / ₄ "	24-1431-25
28,0 cm, 11"	24-1431-28

GEMINI

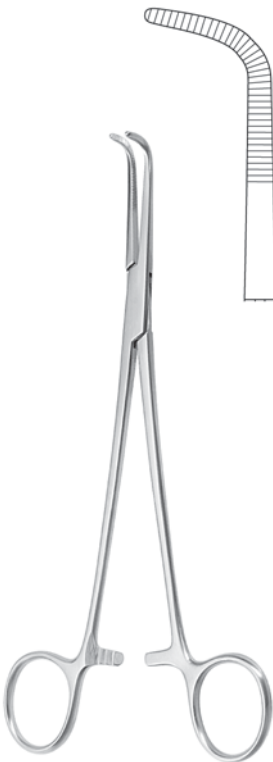

20,0 cm, 8"	24-1433-20
24,0 cm, 9 ¹ / ₂ "	24-1433-24
28,0 cm, 11"	24-1433-28

KANTROWITZ

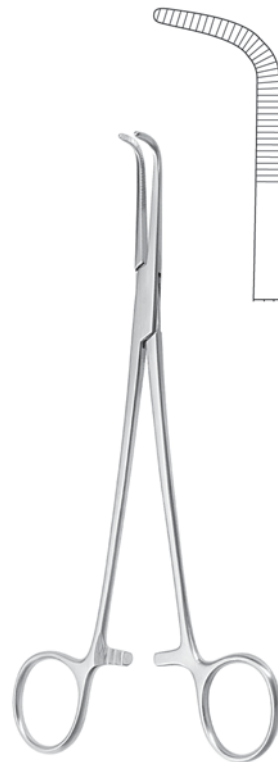

19,0 cm, 7 ¹ / ₂ "	24-1543-19
21,0 cm, 8 ¹ / ₄ "	24-1543-21
24,0 cm, 9 ¹ / ₂ "	24-1543-24

WIKSTROEM

Präparier- und Ligaturklemmen
 Dissecting and Ligature Forceps
 Pinzas de disección y ligaduras
 Pinze per preparazioni e legature



MIXTER
 15,5 cm, 6" 24-1461-15
 19,0 cm, 7½" 24-1461-19



MIXTER-O'SHAUGHNESSY
 15,5 cm, 6" 24-1477-15
 19,0 cm, 7½" 24-1477-19

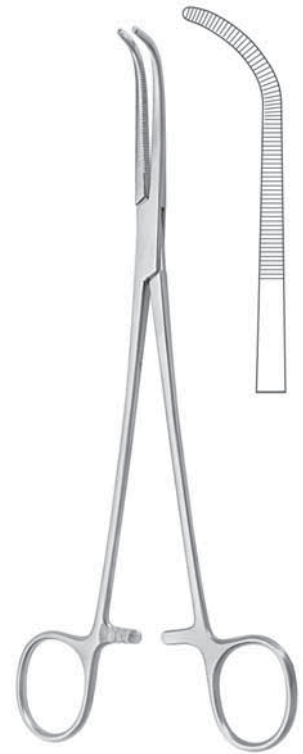

MIXTER
 22,0 cm, 8¾" 24-1473-22



MIXTER
 23,0 cm, 9" 24-1473-23

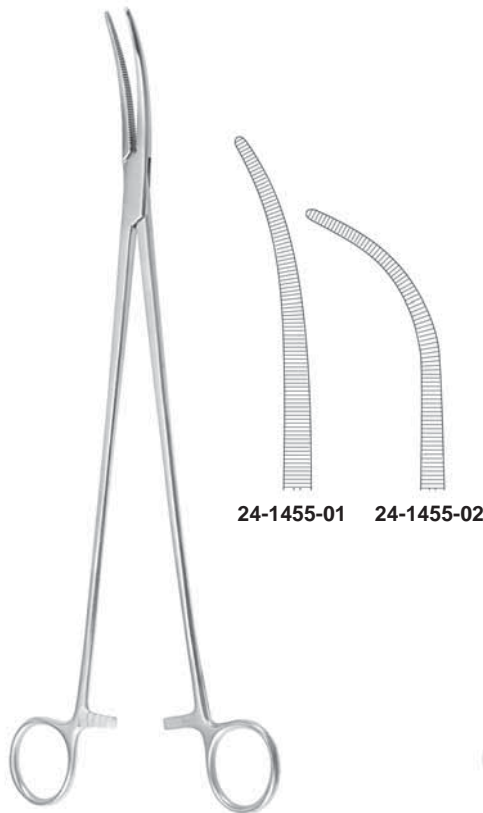

ZENKER

24-1455-01 24-1455-02

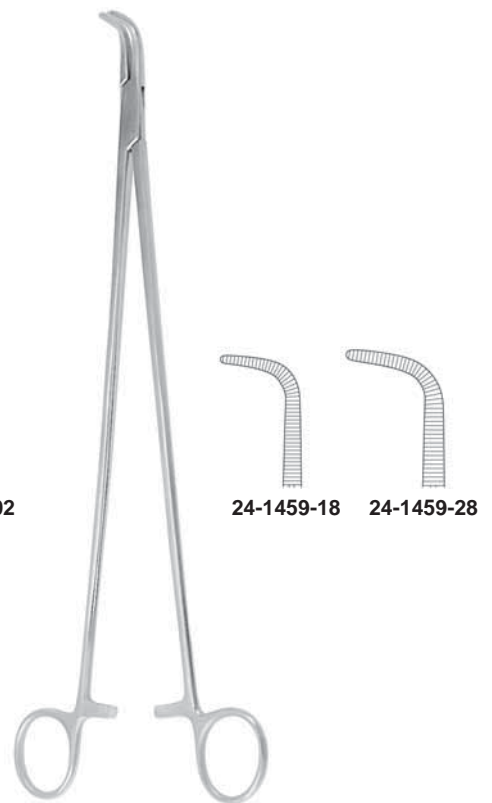

ZENKER

24-1459-18 24-1459-28

Präparier- und Ligaturklemmen
Dissecting and Ligature Forceps
Pinzas de disección y ligaduras
Pinze per preparazioni e legature



LAWRENCE
 27,5 cm, 10³/₄"
 24-1457-28

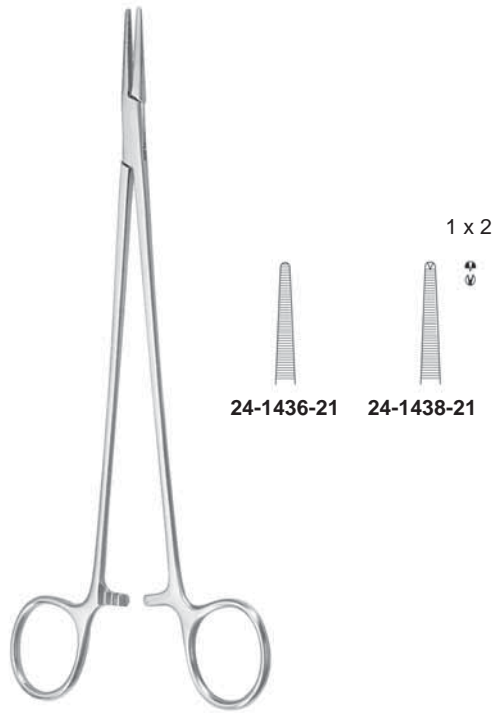

HOSEMANN
 21,0 cm, 8¹/₄"



DESJARDINS
 21,0 cm, 8¹/₄"
 24-1529-21

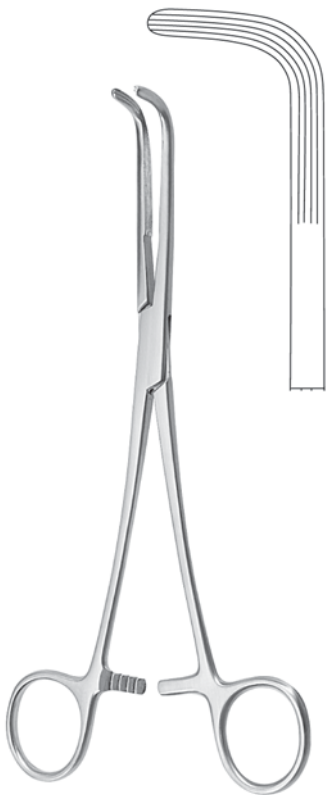

MIXTER
 22,0 cm, 8³/₄" 24-1479-22
 25,0 cm, 9³/₄" 24-1479-25
 28,0 cm, 11" 24-1479-28

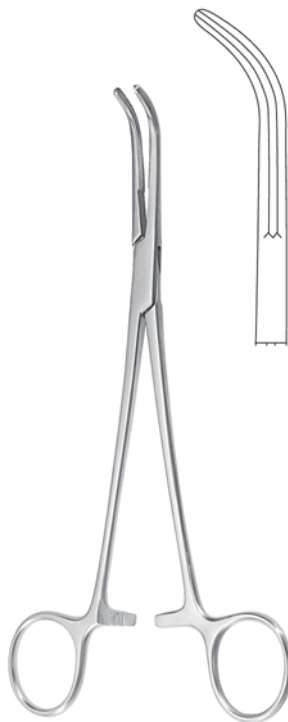

LAHEY
 19,0 cm, 7¹/₂" 24-1501-19
 23,0 cm, 9" 24-1501-23



LOWER
 18,0 cm, 7"
 24-1503-18

Präparier- und Ligaturklemmen
 Dissecting and Ligature Forceps
 Pinzas de disección y ligaduras
 Pinze per preparazioni e legature



MC QUIGG-MIXTER
 22,0 cm, 8³/₄"
 24-1507-22

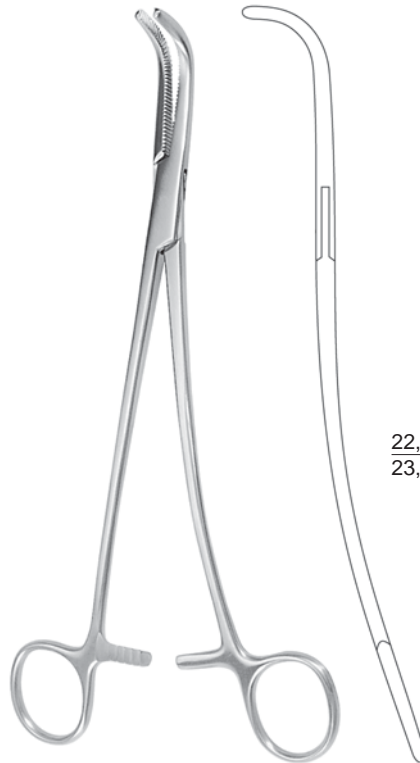

GRAY

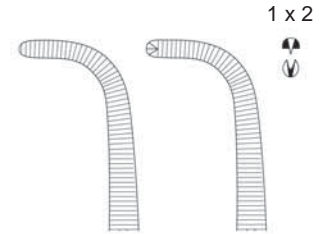

22,0 cm, 8 ³ / ₄ "	24-1523-22	24-1525-22
23,0 cm, 9"	24-1523-23	24-1525-23



CRAFOORD-SELLORS

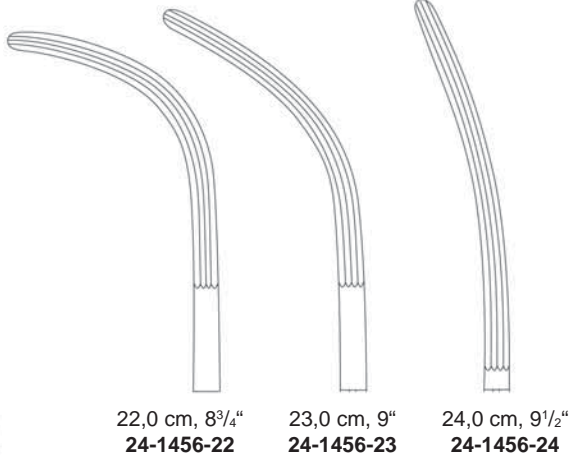

22,0 cm, 8³/₄"
 24-1456-22

23,0 cm, 9"
 24-1456-23

24,0 cm, 9¹/₂"
 24-1456-24



FINOCCHIETTO
 24,0 cm, 9¹/₂"
 24-1505-24

Gallenkanal- und Nierenstielklemmen
 Gall Duct and Kidney Pedicle Clamps
 Pinzas-clamps para pedúnculo renal
 Pinze per peduncoli renali



GUYON

20,0 cm, 8"	24-1509-20
22,0 cm, 8 ³ / ₄ "	24-1509-22
24,0 cm, 9 ¹ / ₂ "	24-1509-24



GUYON

23,0 cm, 9"
24-1513-23

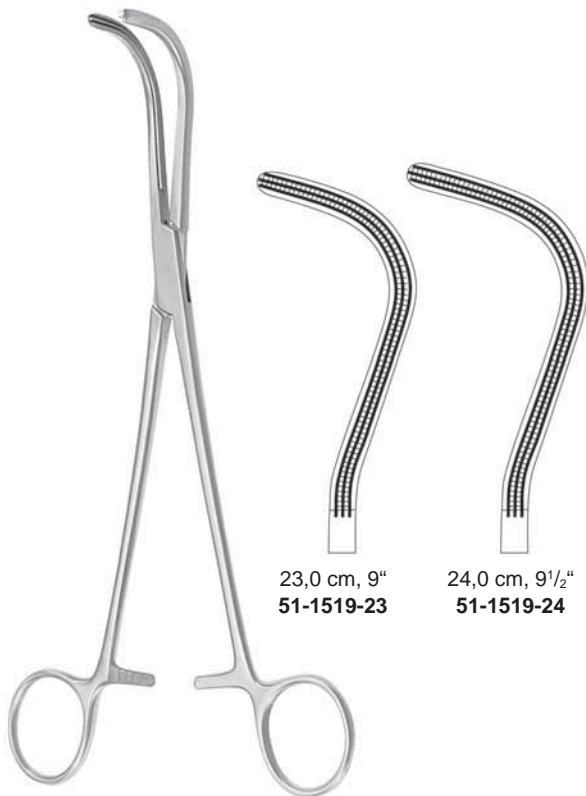

23,0 cm, 9"
51-1519-23

24,0 cm, 9¹/₂"
51-1519-24

GUYON

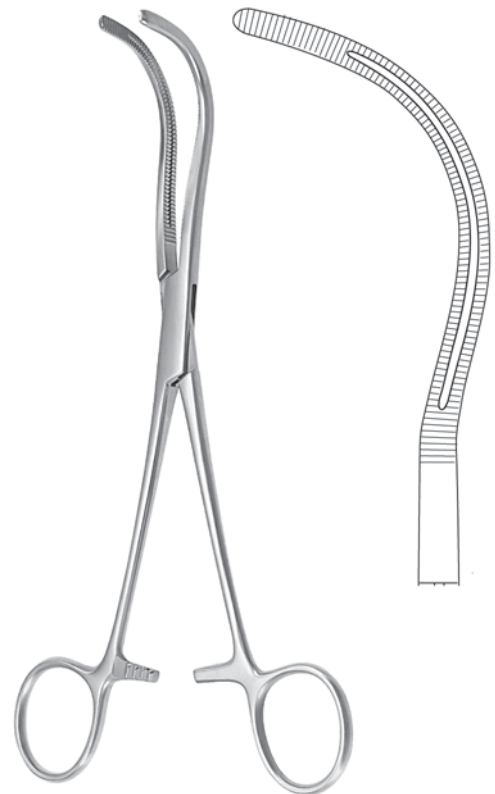

STILLE

23,0 cm, 9"
24-1511-23

Gallenkanal- und Nierenstielklemmen, Bronchusklemmen
 Gall Duct and Kidney Pedicle Clamps, Bronchus Forceps
 Pinzas-clamps para pedúnculo renal, Pinzas-clamps para bronquios
 Pinze per peduncoli renali, Pinze per legature



HERRICK
 23,0 cm, 9"
 24-1517-23



URO-TANGENTIAL



23,0 cm, 9"
 56-1055-01

24,0 cm, 9½"
 56-1055-02



LOVELACE
 20,0 cm, 8"
 48-1004-20



LOVELACE
 20,0 cm, 8"
 48-1005-20

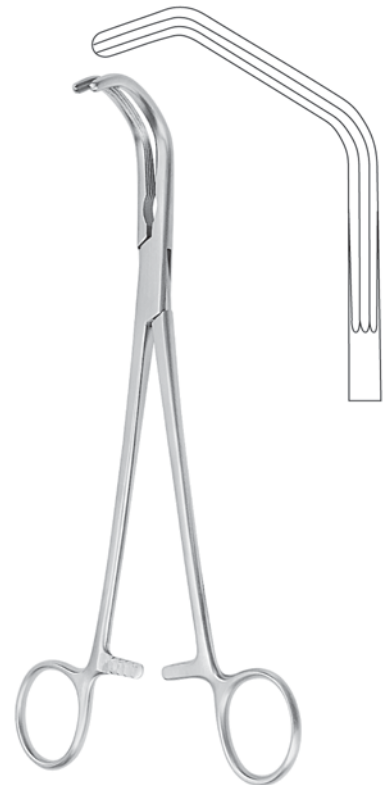

PRICE-THOMAS
 22,0 cm, 8¾"
 48-1001-22

Bronchusklemmen, Peritoneumklemmen, Hysterektomieklemmen
 Bronchus Forceps, Peritoneum Forceps, Hysterectomy Forceps
 Pinzas-clamps para bronquios, Pinzas-clamps para peritoneo y para histerectomía
 Pinze per legature, Pinze per peritoneo e per isterectomia



PRICE-THOMAS
 22,0 cm, 8³/₄"

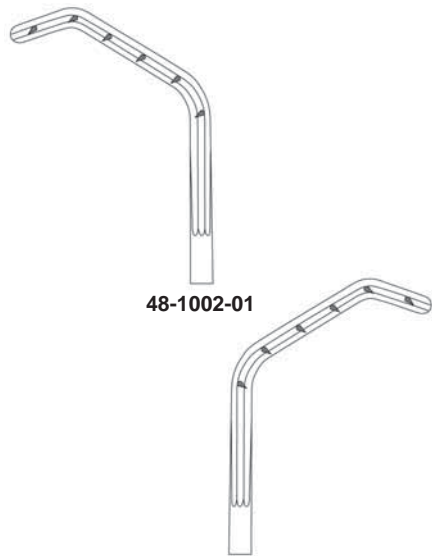

48-1002-01

48-1002-02



SEMB
 24,0 cm, 9¹/₂"

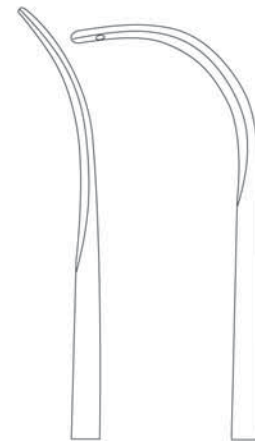

48-1003-01

48-1003-02

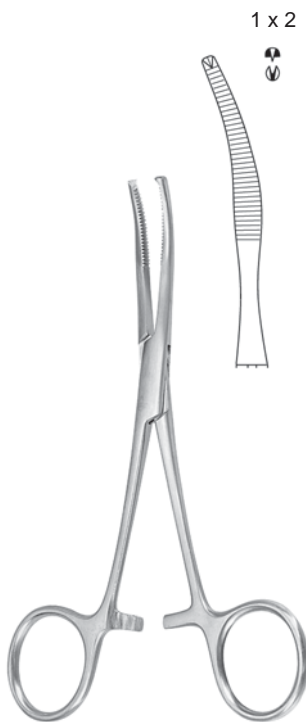

BABY-MIKULICZ
 14,0 cm, 5¹/₂"
 24-1701-14

1 x 2



1 x 2



MIKULICZ
 18,0 cm, 7"
 24-1703-18

1 x 2



1 x 2

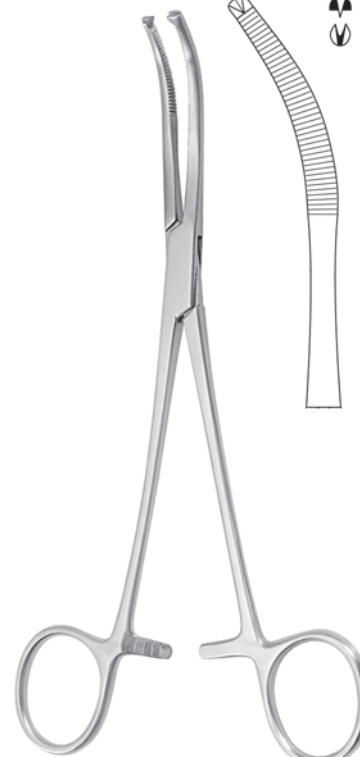

MIKULICZ
 20,0 cm, 8"
 24-1709-20

1 x 2



1 x 2

Peritoneumklemmen, Hysterektomieklemmen
 Peritoneum Forceps, Hysterectomy Forceps
 Pinzas-clamps para peritoneo y para histerectomía
 Pinze per peritoneo e per isterectomia

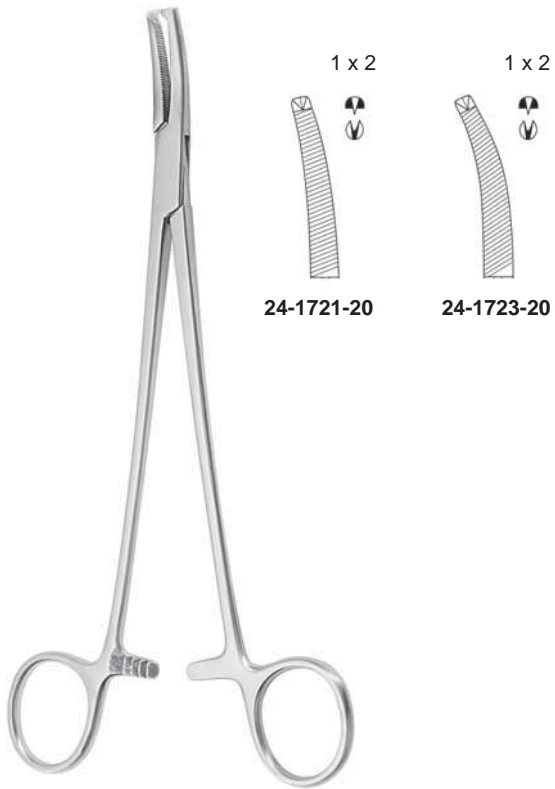

24-1721-20

24-1723-20

FAURE
 20,0 cm, 8"

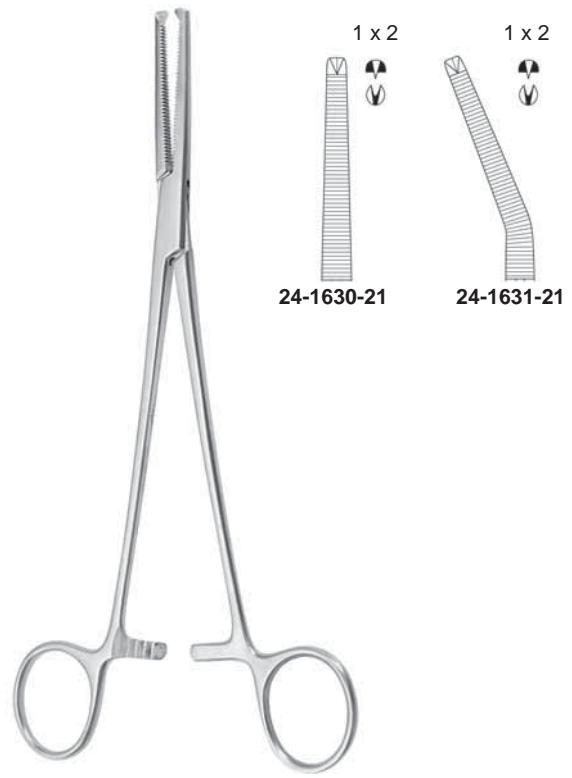

24-1630-21

24-1631-21

PHANEUF
 21,5 cm, 8½"

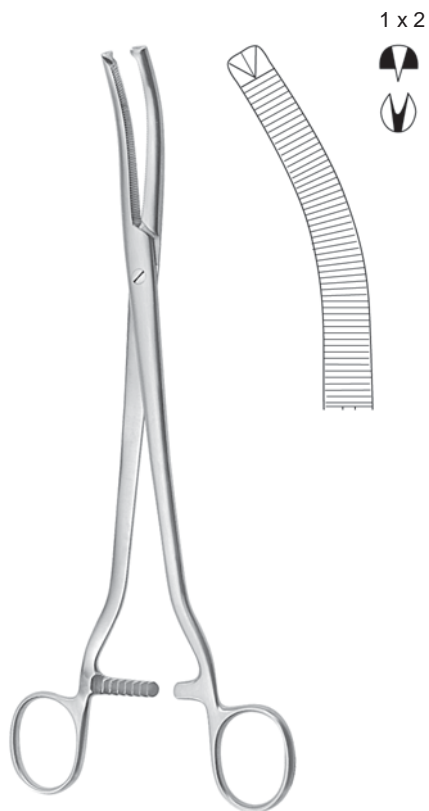

WERTHEIM
 24,0 cm, 9½"
 24-1601-24



WERTHEIM
 25,0 cm, 10"
 24-1602-25

Hysterektomieklemmen
Hysterectomy Forceps
Pinzas-clamps para histerectomía
Pinze per isterectomia

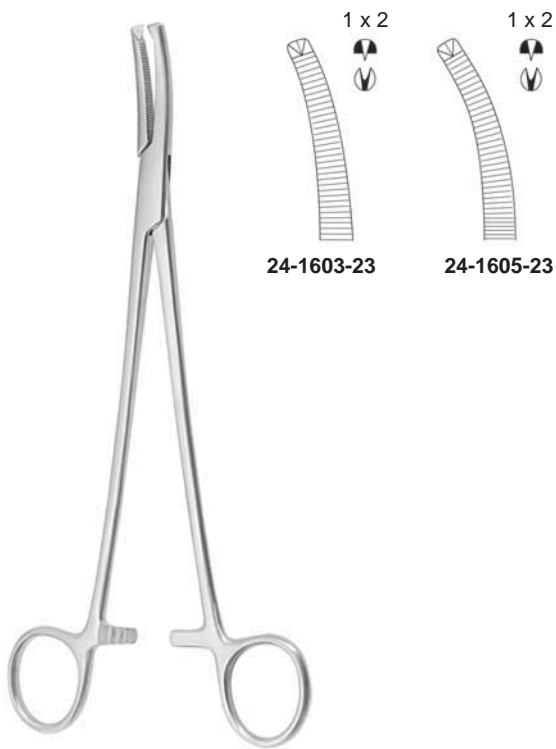

24-1603-23

24-1605-23

WERTHEIM
 23,0 cm, 9"

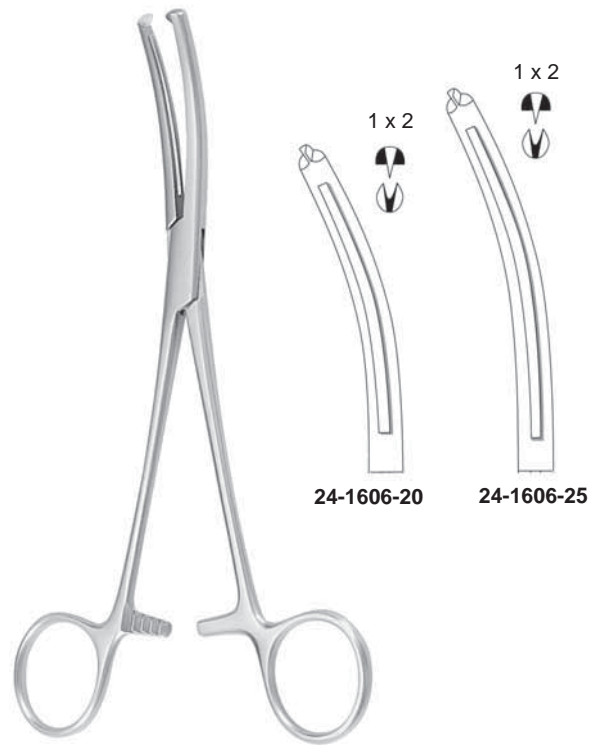

24-1606-20

24-1606-25

MAINGOT
 21,5 cm, 8½"

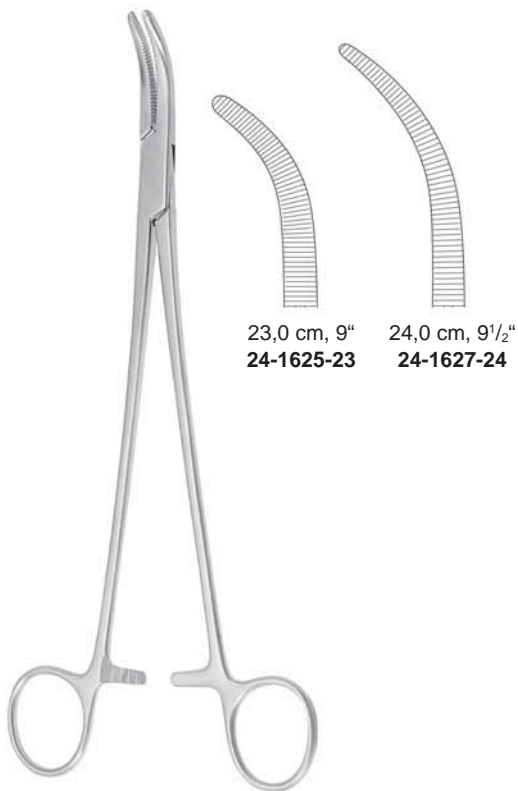

23,0 cm, 9"
 24-1625-23

24,0 cm, 9½"
 24-1627-24

MOYNIHAN



WERTHEIM-CULLEN
 21,5 cm, 8½"
 24-1629-21

Hysterektomieklemmen
 Hysterectomy Forceps
 Pinzas-clamps para histerectomía
 Pinze per isterectomia

1 x 2

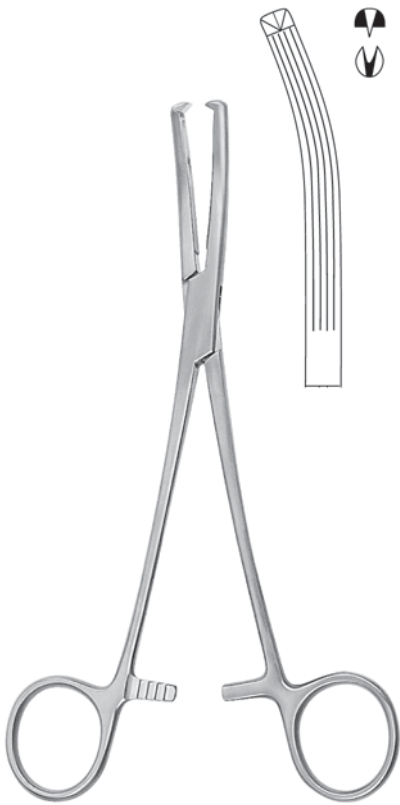

LONG
 19,0 cm, 7 1/4"
 24-1621-19

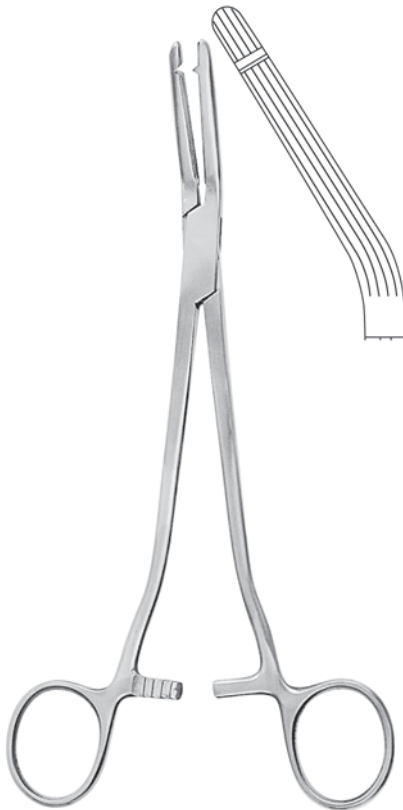

GARLAND
 21,0 cm, 8 1/4"
 24-1623-21



HEANEY
 21,0 cm, 8 1/4"
 24-1607-21

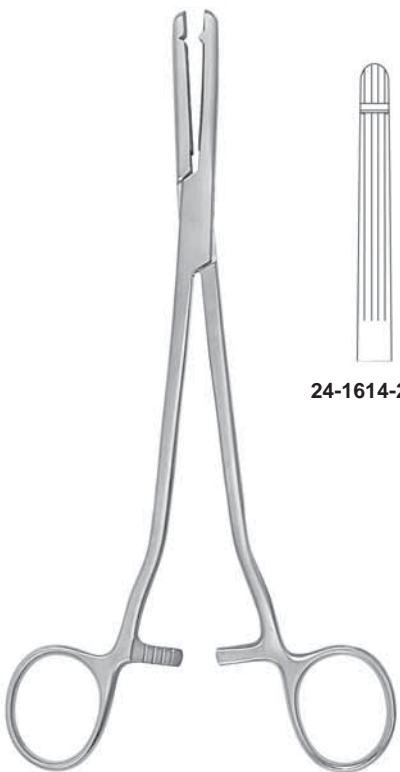

HEANEY-BALLANTINE
 21,0 cm, 8 1/4"

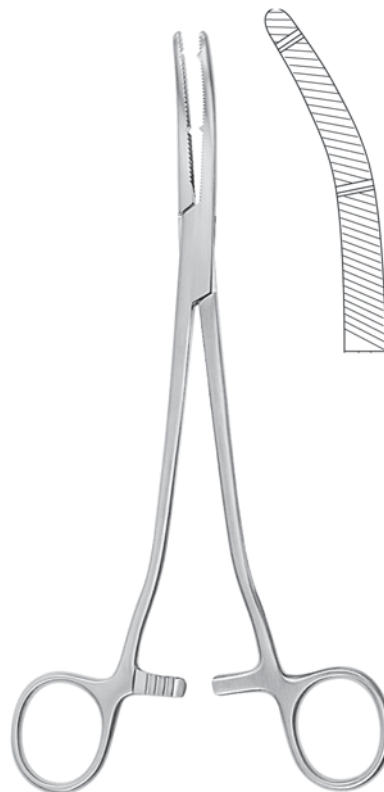
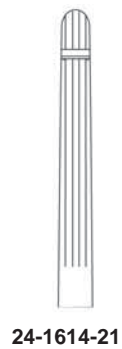

HEANEY-KANTER
 21,0 cm, 8 1/4"
 24-1617-21

Hysterektomieklemmen
Hysterectomy Forceps
Pinzas-clamps para histerectomía
Pinze per isterectomia



HEANEY

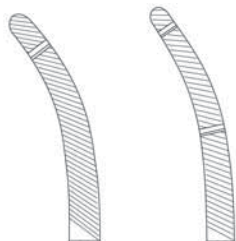

21,0 cm, 8 ¹ / ₄ "	24-1611-21	24-1613-21
23,0 cm, 9"	24-1611-23	24-1613-23

Nahtinstrumente
Suture Instruments
Instrumentos para sutura
Strumenti per sutura



Nadelhalter
Needle Holders
Porta-agujas
Portaghi

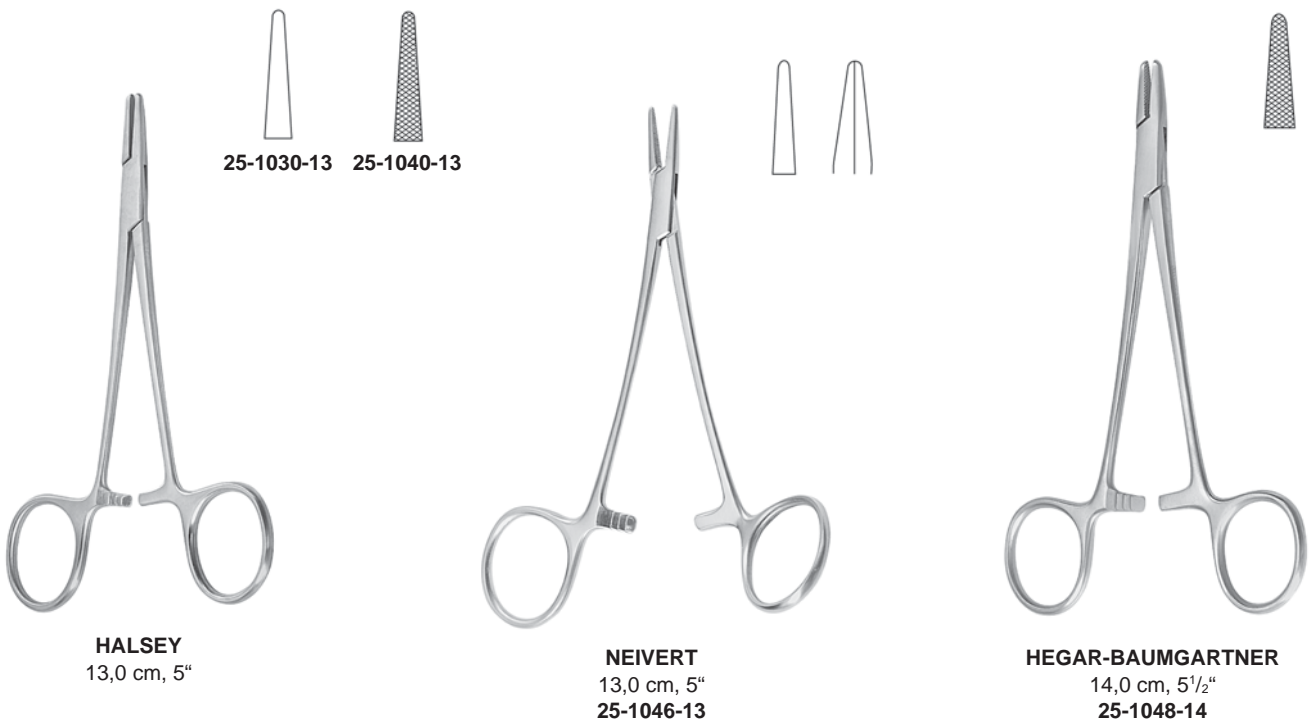
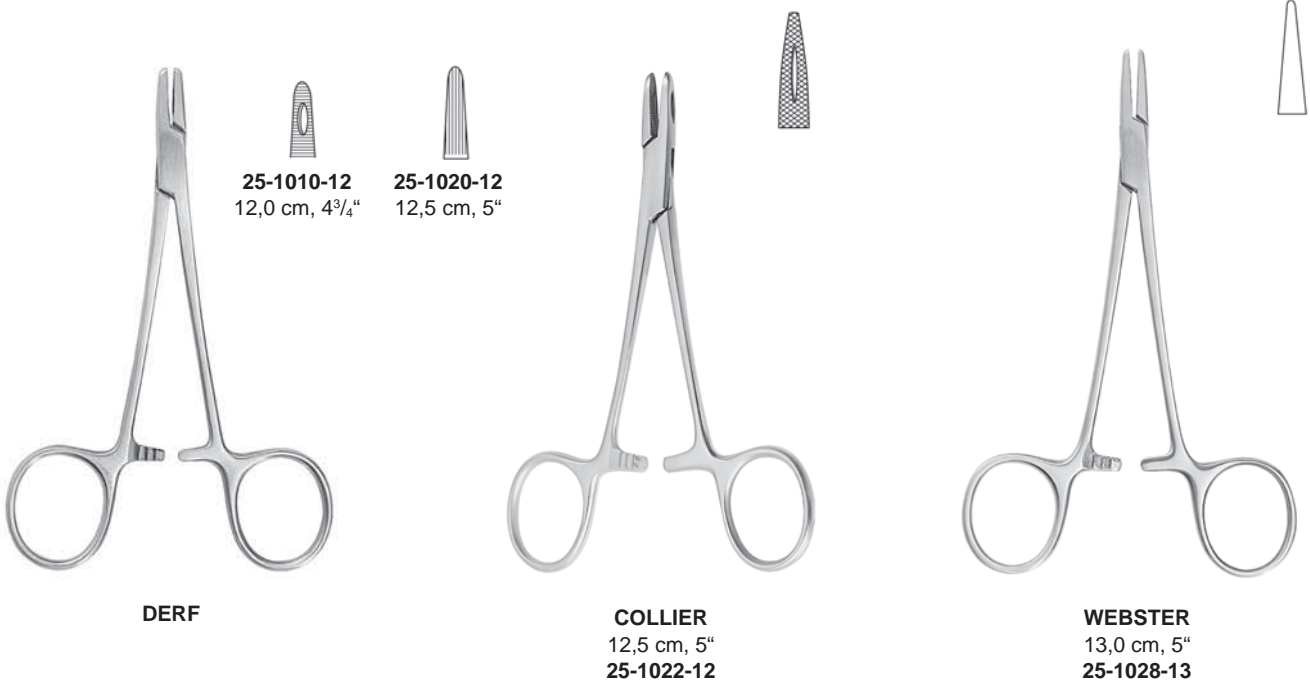

Nadelhalter
Needle Holders
Porta-agujas
Portaghi

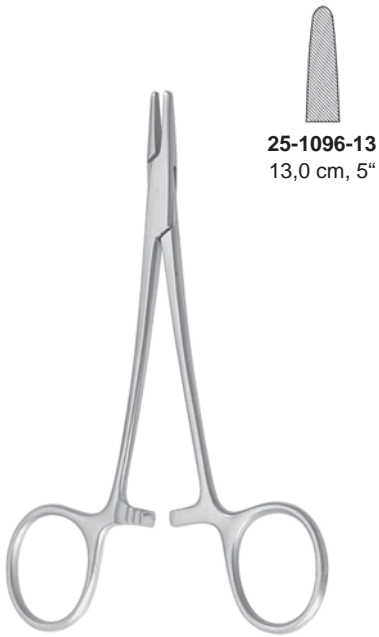

25-1096-13
13,0 cm, 5"

BROWN



CRILE-MURRAY
15,0 cm, 6"
25-1070-15

CRILE-MURRAY

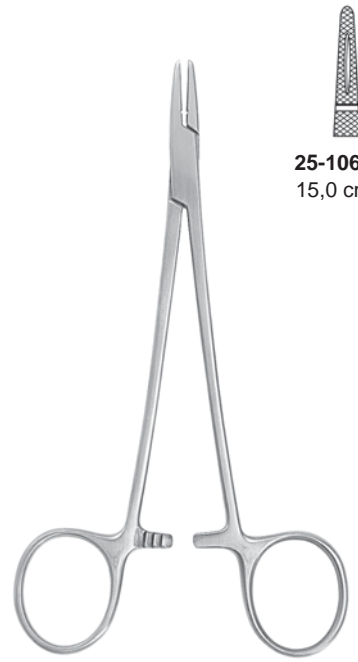

25-1060-15
15,0 cm, 6"

CRILE-WOOD



ADSON
18,0 cm, 7"
25-1192-18

ADSON



METZENBAUM
18,0 cm, 7"
25-1190-18

METZENBAUM



MASS.-GENERAL-HOSPITAL
17,0 cm, 6³/₄"
25-1072-17

MASS.-GENERAL-HOSPITAL

Nadelhalter
Needle Holders
Porta-agujas
Portaghi

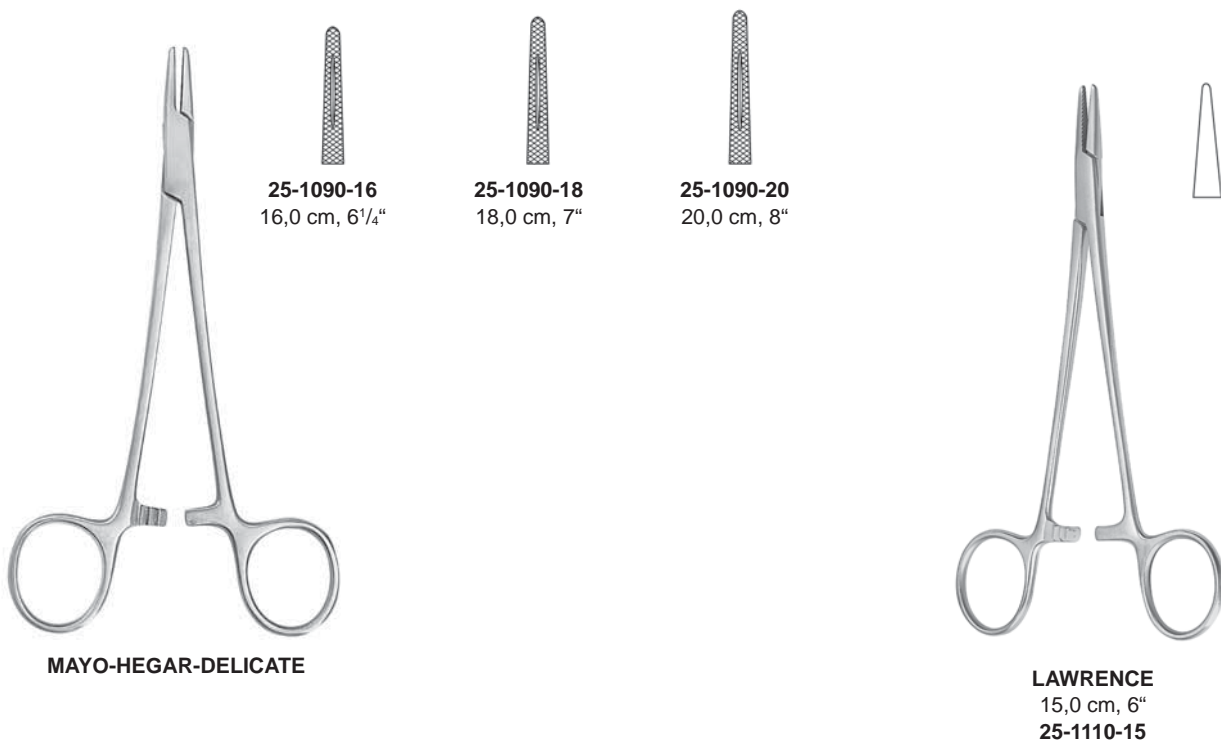

Nadelhalter
Needle Holders
Porta-agujas
Portaghi



HEANEY
21,0 cm, 8¹/₄"
25-1141-21



JAMISON
23,5 cm, 9¹/₄"
25-1148-23



MASSON
27,0 cm, 10¹/₂"
25-1150-27



FINOCCHIETTO
27,0 cm, 10¹/₂"
25-1211-27



WANGENSTEEN
27,0 cm, 10¹/₂"
25-1160-27



JOHNSON
27,0 cm, 10¹/₂"
25-1193-27

Nadelhalter
Needle Holders
Porta-agujas
Portaghi

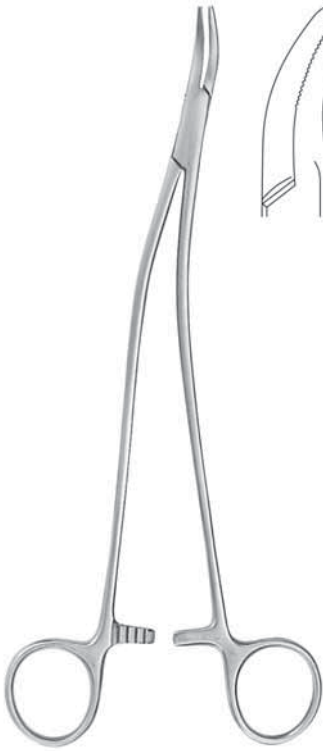

STRATTE
 23,0 cm, 9"
 25-1230-23

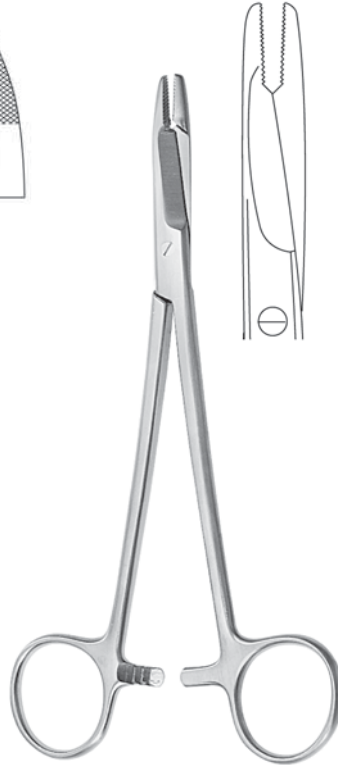

OLSEN-HEGAR
 17,0 cm, 6³/₄"
 25-1310-17

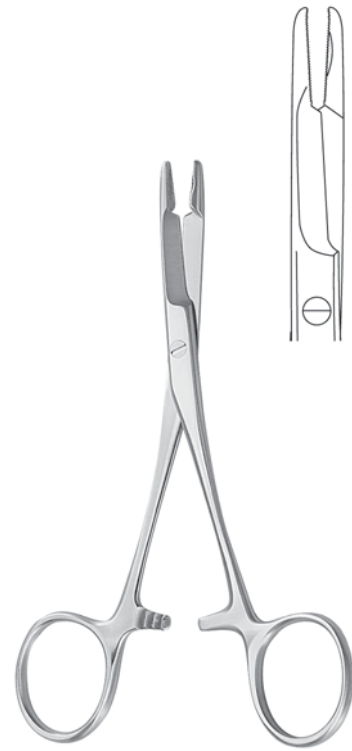

OLSEN-HEGAR
 14,0 cm, 5¹/₂"
 25-1306-14



OLSEN-HEGAR

14,0 cm, 5¹/₂"
 25-1310-14



18,0 cm, 7"
 25-1310-18



TOENNIS
 18,0 cm, 7"
 25-1362-18

Nadelhalter
Needle Holders
Porta-agujas
Portaghi



25-1350-14
14,0 cm, 5½"

MATHIEU



25-1350-17
17,0 cm, 6¾"



25-1350-20
20,0 cm, 8"



25-1356-17
17,0 cm, 6¾"

MATHIEU



25-1356-20
20,0 cm, 8"



LICHTENBERG
20,0 cm, 8"
25-1366-20



MATHIEU



25-1354-14
14,0 cm, 5½"



25-1354-17
17,0 cm, 6¾"

Nadelhalter, Mikro-Nadelhalter
Needle Holders, Micro Needle Holders
Porta-agujas, Micro Porta-agujas
Portaghi, Micro Portaghi



MATHIEU-KOCHER



25-1358-14
14,0 cm, 5 1/2"



25-1358-17
17,0 cm, 6 3/4"



25-1358-20
20,0 cm, 8"



BARRAQUER-TROUTMAN
10,0 cm, 4"



25-1550-10



25-1551-10



BARRAQUER



25-1553-10



25-1553-13



BARRAQUER
13,5 cm, 5 3/8"
25-1621-13



GOMEL
14,0 cm, 5 1/2"
25-1601-14



Mikro-Nadelhalter
 Micro Needle Holders
 Micro Porta-agujas
 Micro Portaghi



25-1600-18 25-1601-18

ohne Sperre
 without ratchet
 sin cremallera
 senza cremagliera

18,5 cm, 7 1/4"



25-1630-18 25-1631-18

mit Sperre
 with ratchet
 con cremallera
 con cremagliera

18,5 cm, 7 1/4"

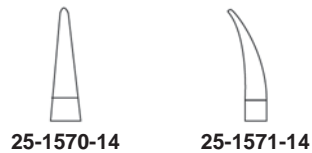

25-1570-14 25-1571-14

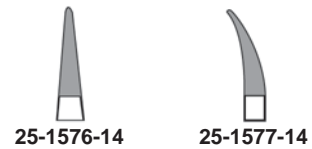

25-1576-14 25-1577-14

mit Sperre
 with ratchet
 con cremallera
 con cremagliera

CASTROVIEJO
 14,5 cm, 5 3/4"



25-1570-18 25-1571-18

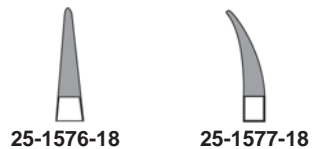

25-1576-18 25-1577-18

mit Sperre
 with ratchet
 con cremallera
 con cremagliera

CASTROVIEJO
 18,0 cm, 7"

Mikro-Nadelhalter
Micro Needle Holders
Micro Porta-agujas
Micro Portaghi

0,4 mm



gerade, ohne Sperre
 straight, without ratchet
 recta, sin cremallera
 retta, senza cremagliera

14,0 cm, 5 1/2"
25-1650-14

0,4 mm



gebogen, ohne Sperre
 curved, without ratchet
 curva, sin cremallera
 curva, senza cremagliera

14,0 cm, 5 1/2"
25-1651-14

0,4 mm



gebogen, mit Sperre
 curved, with ratchet
 curva, con cremallera
 curva, con cremagliera

14,0 cm, 5 1/2"
25-1653-14

0,5 mm



gebogen, ohne Sperre
 curved, without ratchet
 curva, sin cremallera
 curva, senza cremagliera

Ø 10 mm

14,0 cm, 5 1/2"
25-1661-14

0,5 mm



gebogen, mit Sperre
 curved, with ratchet
 curva, con cremallera
 curva, con cremagliera

Ø 10 mm

14,0 cm, 5 1/2"
25-1663-14

0,4 mm



gebogen, ohne Sperre
 curved, without ratchet
 curva, sin cremallera
 curva, senza cremagliera

Ø 8 mm

13,0 cm, 5"
25-1671-13

0,4 mm



gebogen, ohne Sperre
 curved, without ratchet
 curva, sin cremallera
 curva, senza cremagliera

Ø 8 mm

13,0 cm, 5"
25-1673-13

Nadelhalter mit Hartmetalleinlagen
 Needle Holders with tungsten carbide inserts
 Porta-agujas con bocas de carburo tungsteno
 Portaghi con morsi in carburo di tungsteno



KALT
 13,5 cm, 5³/₈"
 26-1428-14



DIETRICH

16,0 cm, 5 ³ / ₈ "	26-1250-16
18,0 cm, 7"	26-1250-18
20,0 cm, 8"	26-1250-20
23,0 cm, 9"	26-1250-23
26,0 cm, 10 ¹ / ₄ "	26-1250-26



WEBSTER
 13,0 cm, 5"
 26-1028-13



DERF
 12,0 cm, 4³/₄"
 26-1010-12



HEGAR-BAUMGARTNER

26-1048-12
 12,5 cm, 5"

26-1048-14
 14,0 cm, 5¹/₂"



WEBSTER
 13,0 cm, 5"
 26-1029-13

Nadelhalter mit Hartmetalleinlagen
Needle Holders with tungsten carbide inserts
Porta-agujas con bocas de carburo tungsteno
Portaghi con morsi in carburo di tungsteno



26-1030-13

26-1040-13

HALSEY
13,0 cm, 5"



26-1060-15
15,0 cm, 6"

26-1060-18
18,0 cm, 7"

CRILE-WOOD



26-1224-18
18,0 cm, 7"

26-1224-20
20,0 cm, 8"

26-1224-26
26,0 cm, 10 1/4"

SAROT

Nadelhalter mit Hartmetalleinlagen
Needle Holders with tungsten carbide inserts
Porta-agujas con bocas de carburo tungsteno
Portaghi con morsi in carburo di tungsteno

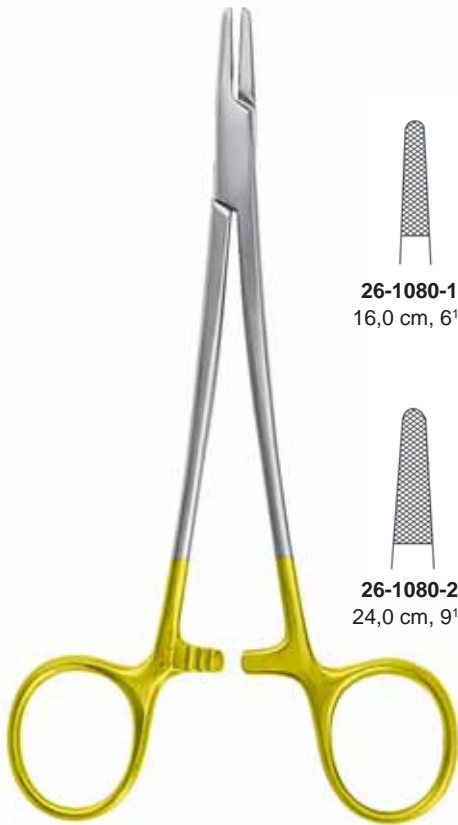

26-1080-16
16,0 cm, 6 1/4"

26-1080-18
18,0 cm, 7"

26-1080-20
20,0 cm, 8"

26-1080-24
24,0 cm, 9 1/2"

26-1080-26
26,0 cm, 10 1/4"

26-1080-30
30,0 cm, 12"

MAYO-HEGAR



26-1141-20
20,0 cm, 8"

26-1141-24
24,0 cm, 9 1/4"

26-1141-26
26,0 cm, 10 1/4"

MAYO-HEGAR (HEANEY)

Nadelhalter mit Hartmetalleinlagen
Needle Holders with tungsten carbide inserts
Porta-agujas con bocas de carburo tungsteno
Portaghi con morsi in carburo di tungsteno

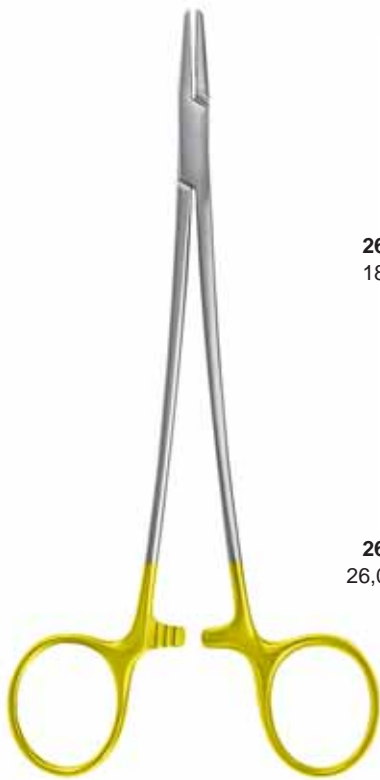

DE BAKEY



26-1114-18
18,0 cm, 7"



26-1114-20
20,0 cm, 8"



26-1114-23
23,0 cm, 9"



26-1114-26
26,0 cm, 10¹/₄"



26-1114-31
31,0 cm, 12¹/₄"



26-1114-37
37,0 cm, 14¹/₂"

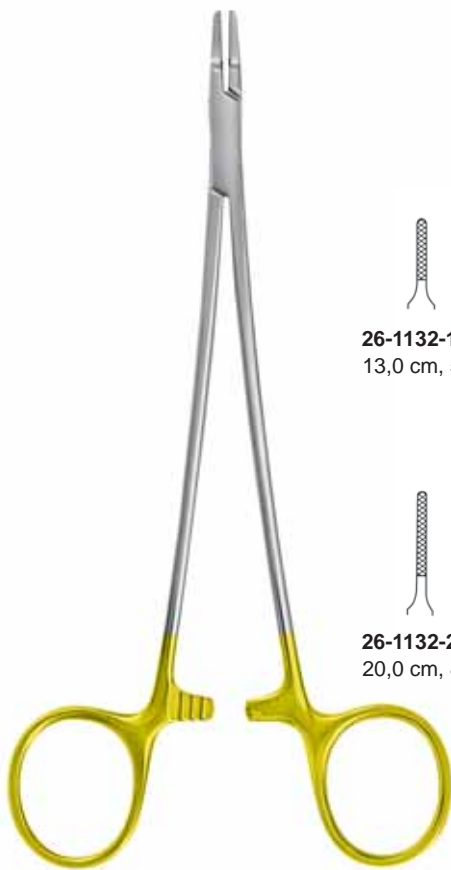

RYDER-VASCULAR



26-1132-13
13,0 cm, 5"

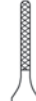

26-1132-15
15,0 cm, 6"

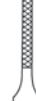

26-1132-18
18,0 cm, 7"

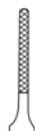

26-1132-20
20,0 cm, 8"

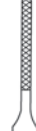

26-1132-23
23,0 cm, 9"



26-1132-26
26,0 cm, 10¹/₄"

Nadelhalter mit Hartmetalleinlagen
Needle Holders with tungsten carbide inserts
Porta-agujas con bocas de carburo tungsteno
Portaghi con morsi in carburo di tungsteno

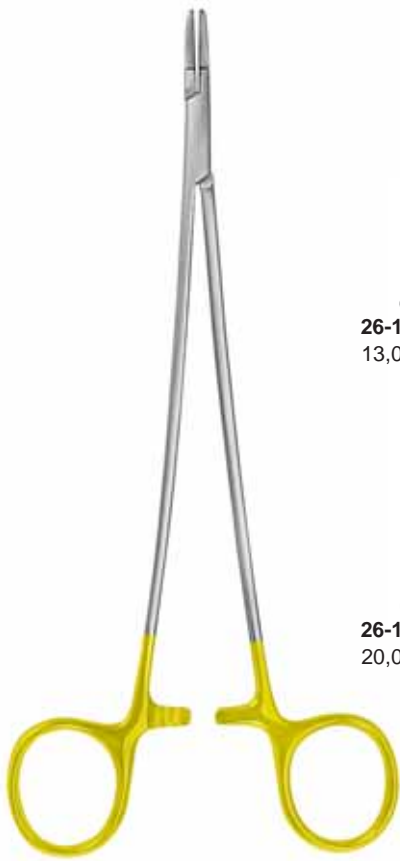

RYDER

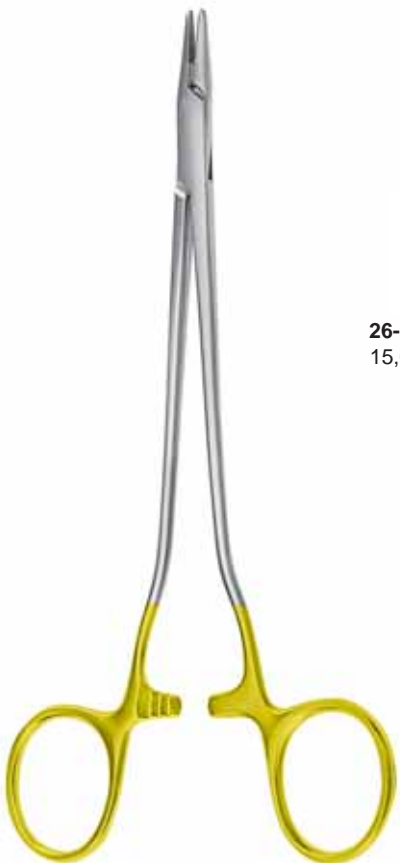
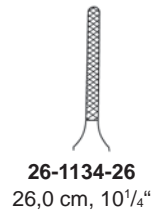
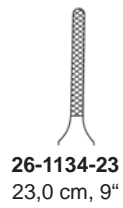
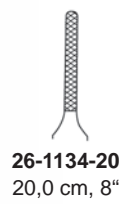
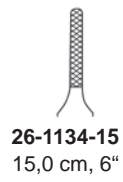

SCHWEDISCHES MODELL

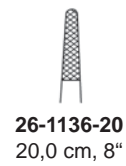
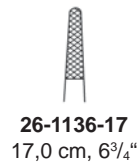
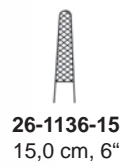

Nadelhalter mit Hartmetalleinlagen
Needle Holders with tungsten carbide inserts
Porta-agujas con bocas de carburo tungsteno
Portaghi con morsi in carburo di tungsteno

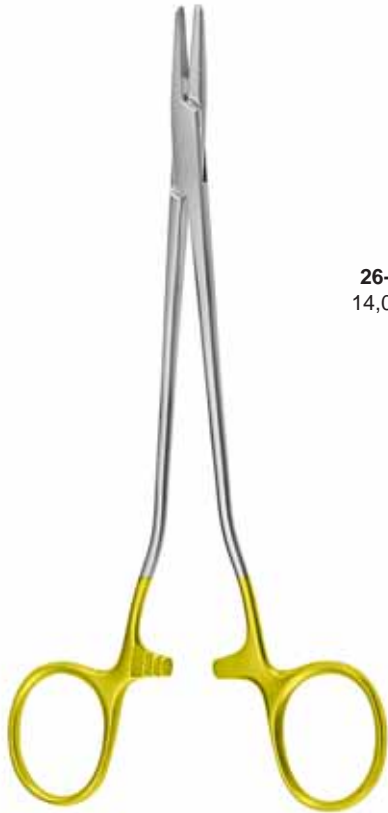

MAYO-HEGAR (HEANEY)



26-1090-14
14,0 cm, 5½"



26-1090-18
18,0 cm, 7"



26-1090-20
20,0 cm, 8"



26-1090-23
23,0 cm, 9"



FINOCCHIETTO
27,0 cm, 10½"
26-1211-27

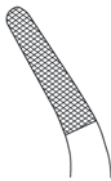

MASSON
27,0 cm, 10½"
26-1150-27



WANGENSTEEN
27,0 cm, 10½"
26-1160-27



Nadelhalter mit Hartmetalleinlagen
Needle Holders with tungsten carbide inserts
Porta-agujas con bocas de carburo tungsteno
Portaghi con morsi in carburo di tungsteno



BOZEMANN



26-1185-20
20,0 cm, 8"



26-1185-24
24,0 cm, 9⁵/₈"



26-1185-26
26,0 cm, 10¹/₄"



HEGAR



26-1084-20
20,0 cm, 8"



26-1084-24
24,0 cm, 9⁵/₈"



BARRY STERNAL



26-1240-15
15,0 cm, 6"



26-1242-20
20,0 cm, 8"

Nadelhalter mit Hartmetalleinlagen
Needle Holders with tungsten carbide inserts
Porta-agujas con bocas de carburo tungsteno
Portaghi con morsi in carburo di tungsteno



26-1230-22
 22,0 cm, 8⁵/₈"

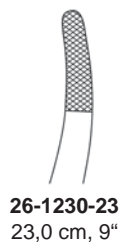

26-1230-23
 23,0 cm, 9"



GILLIES
 16,0 cm, 6¹/₄"
26-1330-16



26-1310-14
 14,0 cm, 5¹/₂"

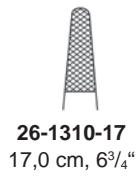

26-1310-17
 17,0 cm, 6³/₄"



26-1310-18
 18,0 cm, 7"

OLSEN-HEGAR



TOENNIS
 18,0 cm, 7"
26-1362-18

Nadelhalter mit Hartmetalleinlagen
Needle Holders with tungsten carbide inserts
Porta-agujas con bocas de carburo tungsteno
Portaghi con morsi in carburo di tungsteno



MATHIEU-KOCHER

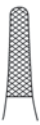

26-1358-14
14,0 cm, 5½"



26-1358-17
17,0 cm, 6¾"



26-1358-20
20,0 cm, 8"



MATHIEU



26-1350-14
14,0 cm, 5½"



26-1350-17
17,0 cm, 6¾"



26-1350-20
20,0 cm, 8"

Nadelhalter mit Hartmetalleinlagen
Needle Holders with tungsten carbide inserts
Porta-agujas con bocas de carburo tungsteno
Portaghi con morsi in carburo di tungsteno



26-1366-17
 17,0 cm, 6³/₄"



26-1366-20
 20,0 cm, 8"

LICHTENBERG



26-1356-17
 17,0 cm, 6³/₄"

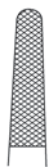

26-1356-20
 20,0 cm, 8"



26-1356-23
 23,0 cm, 9"

MATHIEU

Nadelhalter mit Hartmetalleinlagen
Needle Holders with tungsten carbide inserts
Porta-agujas con bocas de carburo tungsteno
Portaghi con morsi in carburo di tungsteno



26-1364-20
20,0 cm, 8"

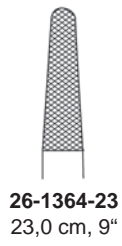

26-1364-23
23,0 cm, 9"

ZWEIFEL



26-1360-18
18,0 cm, 7"

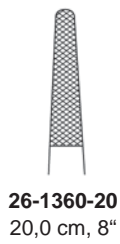

26-1360-20
20,0 cm, 8"

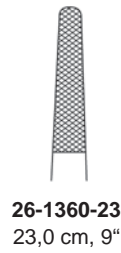

26-1360-23
23,0 cm, 9"

LANGENBECK

Nadelhalter mit Hartmetalleinlagen
Needle Holders with tungsten carbide inserts
Porta-agujas con bocas de carburo tungsteno
Portaghi con morsi in carburo di tungsteno

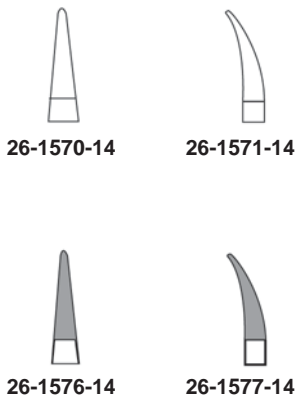

mit Sperre
with ratchet
con cremallera
con cremagliera

CASTROVIEJO
14,5 cm, 5³/₄"

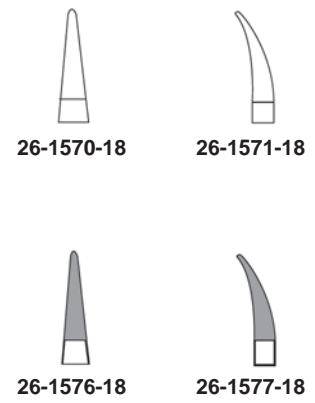

mit Sperre
with ratchet
con cremallera
con cremagliera

CASTROVIEJO
18,0 cm, 7"

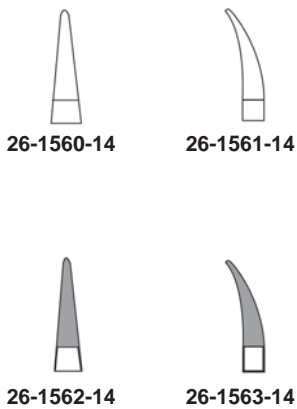

mit Sperre
with ratchet
con cremallera
con cremagliera

BARRAQUER
14,5 cm, 5³/₄"



HEPP SCHEIDEL
18,0 cm, 7"
26-1390-18



REVERDIN
 14,0 cm, 5½"

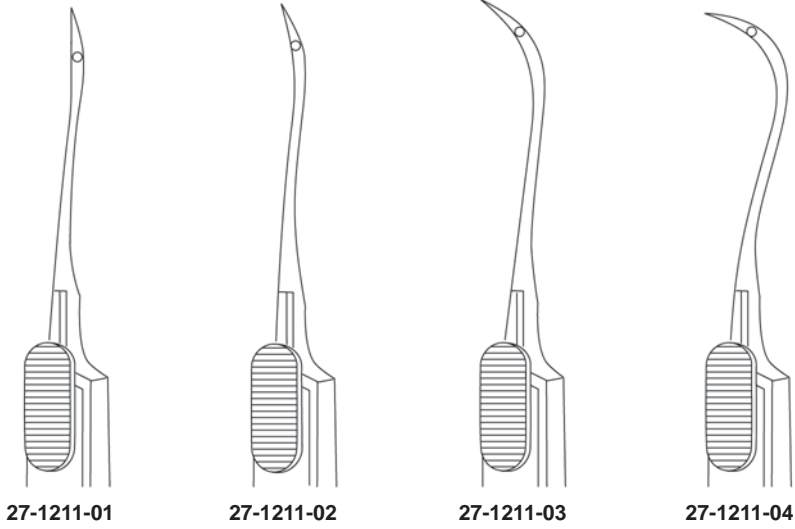

19,5 cm, 7¾"	27-1221-01	27-1221-02	27-1221-03	27-1221-04
22,5 cm, 8¾"	27-1223-01	27-1223-02	27-1223-03	27-1223-04

REVERDIN

Unterbindungsnadeln
Ligature Needles
Agujas para ligaduras
Aghi per legatura

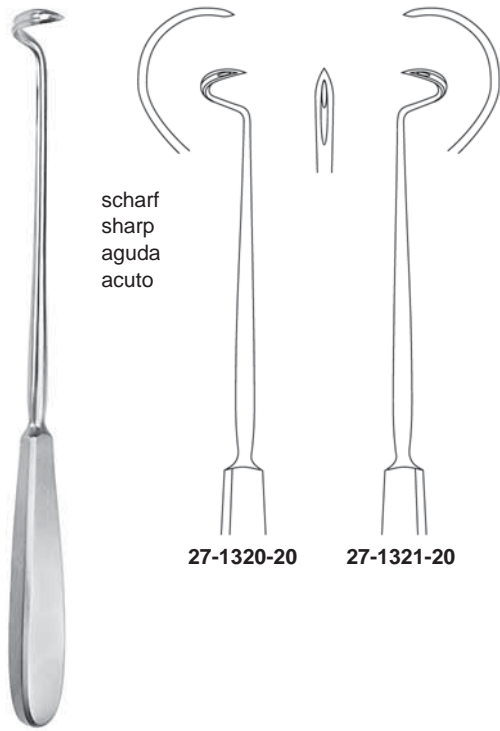

scharf
 sharp
 aguda
 acuto

27-1320-20

27-1321-20

DESCHAMPS
 20,0 cm, 8"

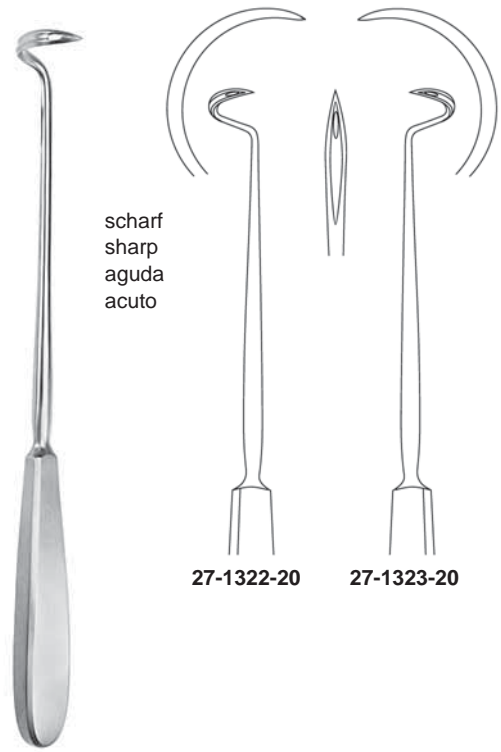

scharf
 sharp
 aguda
 acuto

27-1322-20

27-1323-20

DESCHAMPS
 20,0 cm, 8"

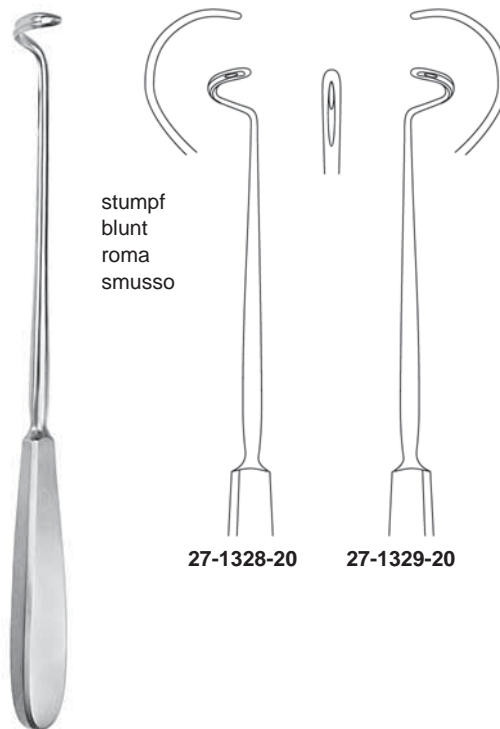

stumpf
 blunt
 roma
 smusso

27-1328-20

27-1329-20

DESCHAMPS
 20,0 cm, 8"

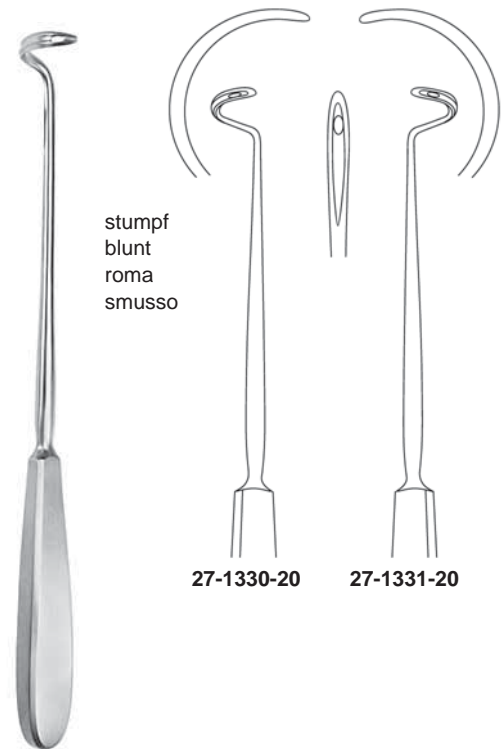

stumpf
 blunt
 roma
 smusso

27-1330-20

27-1331-20

DESCHAMPS
 20,0 cm, 8"

Unterbindungsnadeln
 Ligature Needles
 Agujas para ligaduras
 Aghi per legatura

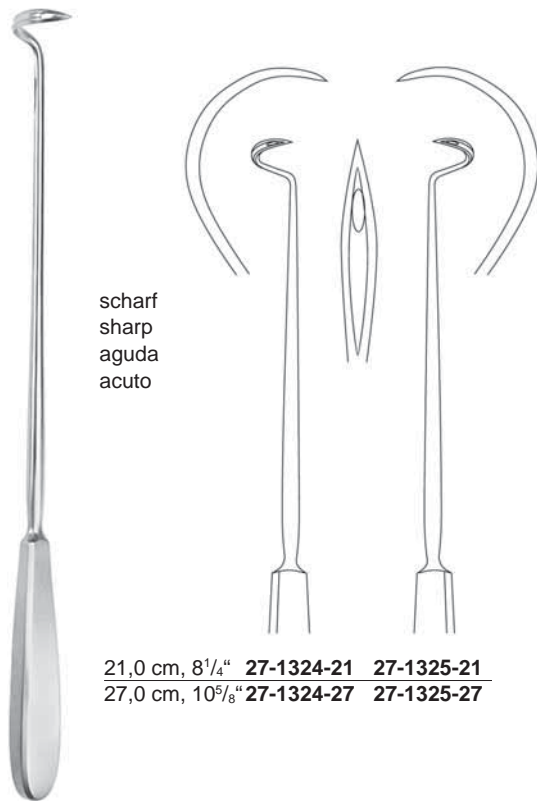

scharf
 sharp
 aguda
 acuto

21,0 cm, 8¹/₄" 27-1324-21 27-1325-21
 27,0 cm, 10⁵/₈" 27-1324-27 27-1325-27

DESCHAMPS

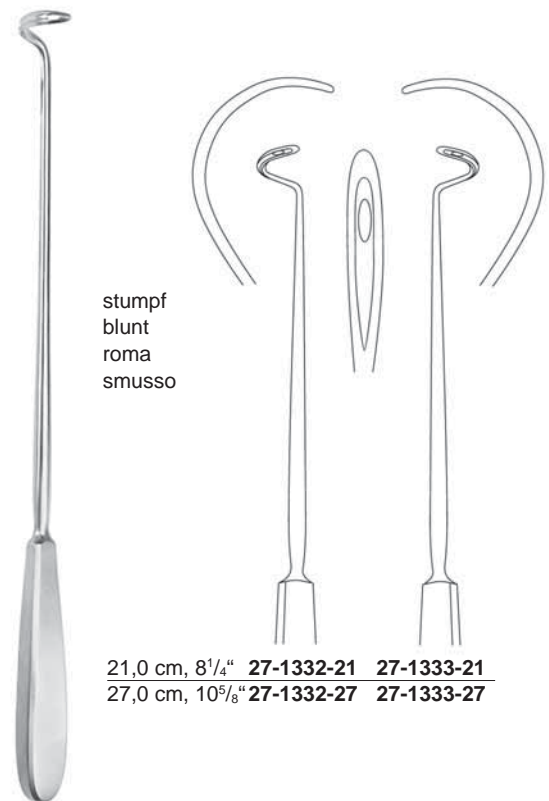

stumpf
 blunt
 roma
 smusso

21,0 cm, 8¹/₄" 27-1332-21 27-1333-21
 27,0 cm, 10⁵/₈" 27-1332-27 27-1333-27

DESCHAMPS



biegsam
 malleable
 maleable
 malleabile

20,0 cm, 8"
 27-1450-20



COOPER
 19,0 cm, 7¹/₂"
 27-1451-19



COOPER
 20,0 cm, 8"
 27-1451-20



SYME
 15,0 cm, 6"
 27-1453-15

Unterbindungsnadeln
Ligature Needles
Agujas para ligaduras
Aghi per legatura



27-1452-01

KOCHER
 19,0 cm, 7½"



27-1452-02



27-1452-03



BRUNNER
 25,0 cm, 9¾"

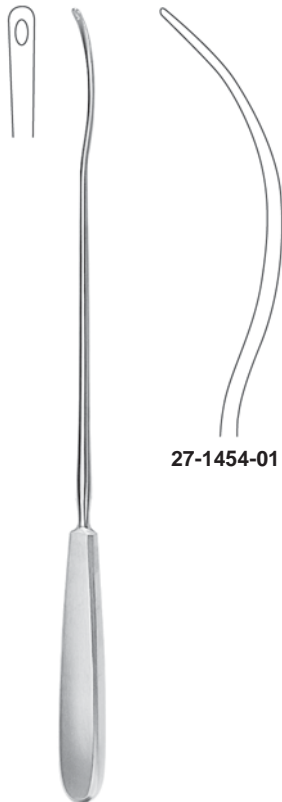

27-1454-01

BRUNNER
 30,0 cm, 11¾"



27-1454-02



SCHMIEDEN
 21,0 cm, 8¼"

27-1458-21

Unterbindungsnadeln
 Ligature Needles
 Agujas para ligaduras
 Aghi per legatura



27-1460-01



27-1460-02



27-1460-03

YOUNG-HRYNTSCHAK
 24,0 cm, 9 1/2"
 27-1460-24



DE LA ROZA
 12,0 cm, 4 3/4"
 27-1467-01



DE LA ROZA
 12,0 cm, 4 3/4"
 27-1467-02



JAKOBI
 14,0 cm, 5 1/2"
 27-1469-14



HESSEBERG
 15,0 cm, 6"
 27-1468-15



KRONECKER
 15,0 cm, 6"
 27-1470-01

Unterbindungsnadeln
Ligature Needles
Agujas para ligaduras
Aghi per legatura



KRONECKER
 15,0 cm, 6"
 27-1470-02



TRÉLAT
 23,0 cm, 9"
 27-1472-23



CLAUS
 23,0 cm, 9"
 27-1473-23



HURD
 21,0 cm, 8 1/4"
 27-1474-01



HURD
 21,0 cm, 8 1/4"
 27-1474-02



NAGER
 24,0 cm, 9 1/2"
 27-1477-24



CLAUS-EICKEN
 23,0 cm, 9"
 27-1481-23



FALK
 24,0 cm, 9 1/2"
 27-1480-01



FALK
 24,0 cm, 9 1/2"
 27-1480-02

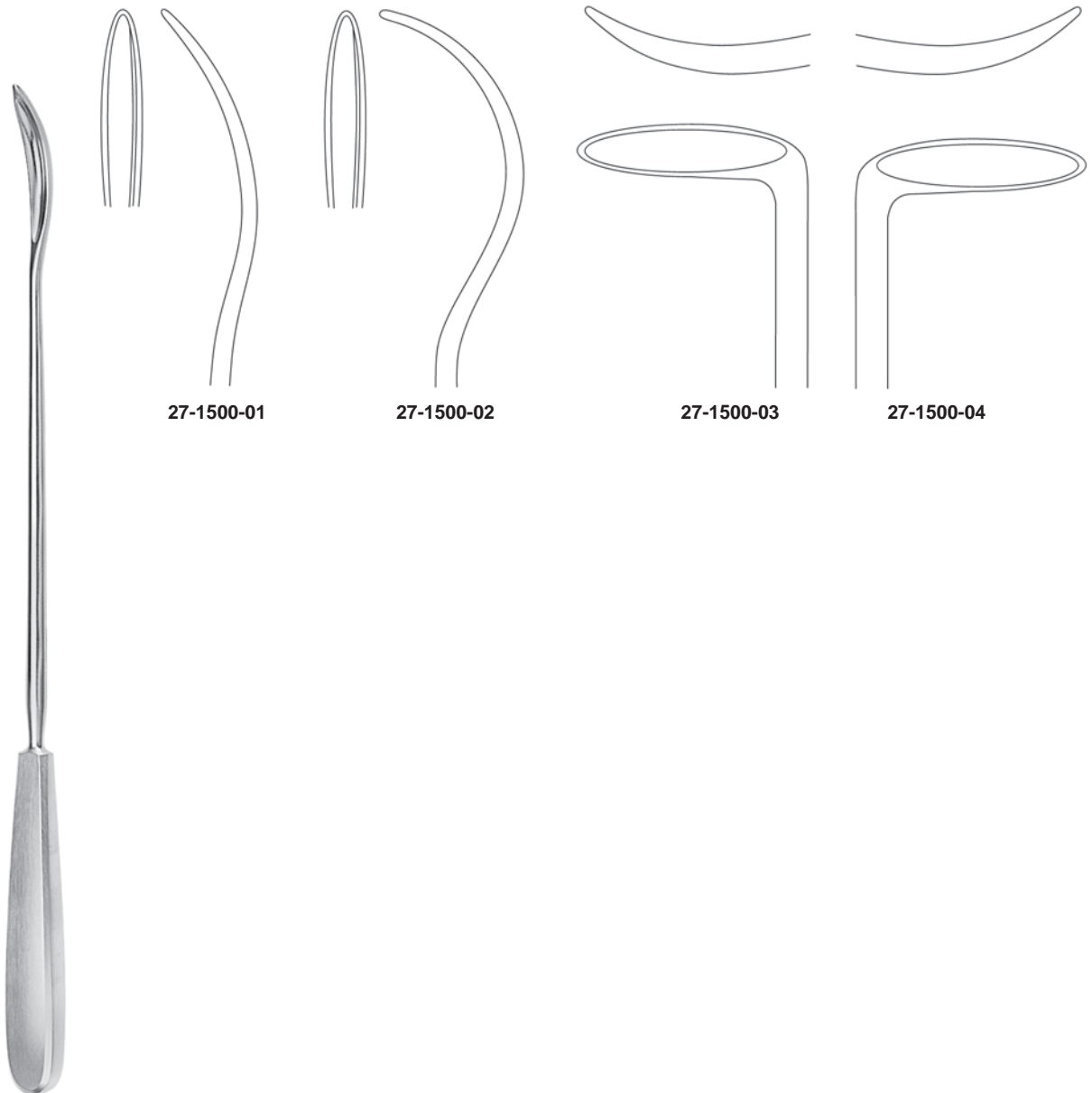

BRUNNER
30,0 cm, 11³/₄"

Führungshohlsonden
 Ligature Conductors
 Sondas conductoras
 Sonde conduttrice



PAYR
 22,0 cm, 8⁵/₈"
 27-1502-22



PAYR
 22,0 cm, 8⁵/₈"
 27-1503-22



mit Loch
 with hole
 con foro
 con ago

SCHMIEDEN-PAYR
 19,0 cm, 7¹/₂"
 27-1506-19



ohne Loch
 without hole
 sin foro
 senza ago

SCHMIEDEN
 19,0 cm, 7¹/₂"
 27-1507-19



KÖNIG
 19,5 cm, 7³/₄"
 27-1508-03



KÖNIG
 19,5 cm, 7³/₄"
 27-1508-05



KÖNIG
 19,5 cm, 7³/₄"
 27-1508-07



25,5 cm, 10"
 27-1510-25

28,0 cm, 11"
 27-1510-28

KIRSCHNER



BRUNNER-FERROZELL
 18,0 cm, 7" 27-1521-18
 27,0 cm, 10⁵/₈" 27-1521-27



KOCHER



15,0 cm, 6" 27-1513-15 27-1514-15
 16,0 cm, 6¹/₄" 27-1513-16 27-1514-16



18,0 cm, 7"
 27-1516-18

Nahtinstrumente
 Suture Instruments
 Instrumentos para sutura
 Strumenti per sutura



MOD. WIEN
 23,5 cm, 9¹/₄"
 27-1532-23



BOZEMANN
 21,0 cm, 8¹/₄"
 27-1531-21



23,0 cm, 9"
 27-1530-23



MICHEL
 12,0 cm, 4³/₄"
 27-1550-12



COLLIN
 13,0 cm, 5"
 27-1552-13



RICHTER-HEATH
 14,0 cm, 5¹/₂"
 27-1553-14



WACHENFELDT
 12,5 cm, 5"
 27-1555-01



HEGENBARTH
 12,5 cm, 5"
 27-1556-12



MICHEL
12,0 cm, 4³/₄"
27-1558-12



LANGE
10,0 cm, 4"
27-1559-10

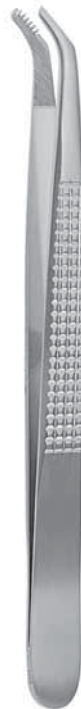

CHILDE
18,0 cm, 7"
27-1560-01



CHILDE CLIP
18,0 cm, 7"
27-1560-02

	27-1570-08	7,5 x 1,75 mm
	27-1570-11	11,0 x 2,0 mm
	27-1570-12	12,0 x 3,0 mm
	27-1570-14	14,0 x 3,0 mm
	27-1570-16	16,0 x 3,0 mm
	27-1570-18	18,0 x 3,0 mm
	27-1570-20	20,0 x 3,0 mm
	27-1570-22	22,0 x 3,0 mm

MICHEL

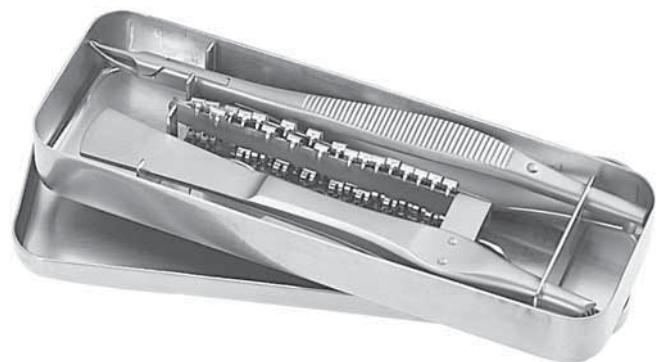

CLIP-SET
27-1558-00

bestehend aus, consisting of, compuesto de, composto da

- 1 x **27-1558-12**
- 1 x **27-1550-12**
- 50 x **27-1570-14**
- 1 x **27-1590-01** (Etui)

**Wundhaken
Retractors
Separadores
Divaricatori**



Dura- und Hauthäkchen
Dura and Skin Retractors
Gancho para piel y dura-madre
Unico per pelle e dura-madre



Fig. 1
 28-1050-01



Fig. 2
 28-1050-02

GILLIES
 18,0 cm, 7"



KILNER
 15,0 cm, 6"
 28-1054-15



FRAZIER
 13,0 cm, 5"
 28-1060-13



O'CONNOR
 16,0 cm, 6 1/4"
 28-1074-16



Fig. 1
 28-1058-01



Fig. 2
 28-1058-02



Fig. 3
 28-1058-03

KLEINERT-KUTZ
 16,0 cm, 6 1/4"



JOSEPH
 16,0 cm, 6 1/4"
 28-1062-16



GRAEFE
 16,0 cm, 6 1/4"

Fig. 1
 28-1078-01



Fig. 2
 28-1078-02



Dura- und Hauthäkchen
Dura and Skin Retractors
Gancho para piel y dura-madre
Unico per pelle e dura-madre



Fig. 1
28-1070-01



Fig. 2
28-1070-02



Fig. 3
28-1070-03



Fig. 4
28-1070-04



16,0 cm, 6 1/4"



Fig. 1
28-1080-01



Fig. 2
28-1080-02



GUTHRIE
 16,0 cm, 6 1/4"



Fig. 1
28-1086-01



Fig. 2
28-1086-02



Fig. 3
28-1086-03



Fig. 4
28-1086-04



JOSEPH
 16,0 cm, 6 1/4"

Wundhaken
Retractors
Separadores
Divaricatori



Fig. 1
28-1082-01

scharf
sharp
agudos
acuti

KNAPP
13,0 cm, 5"



Fig. 2
28-1082-02

stumpf
blunt
romo
smusso



16,0 cm, 6 1/4"



28-1088-02



28-1088-03



28-1088-04

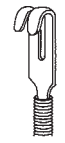

28-1089-02



28-1089-03

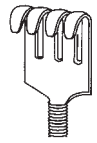

28-1089-04

flexibel · flexible · flexibles · flessibili



16,0 cm, 6 1/4"



28-1101-01



28-1101-02



28-1101-03



28-1101-04

scharf
sharp
agudos
acuti



28-1103-01



28-1103-02



28-1103-03



28-1103-04

halbscharf
semi-sharp
semi-agudos
semi-acuti



28-1102-01



28-1102-02



28-1102-03



28-1102-04

stumpf
blunt
romo
smusso

**Wundhaken
Retractors
Separadores
Divaricatori**



16,0 cm, 6¹/₄"



28-1111-01



28-1111-02



28-1111-03



28-1111-04

scharf
sharp
agudos
acuti



28-1112-01



28-1112-02



28-1112-03

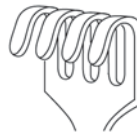

28-1112-04

stumpf
blunt
romo
smusso



CUSHING
19,0 cm, 7¹/₂"



Fig. 1
28-1140-01

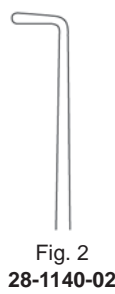
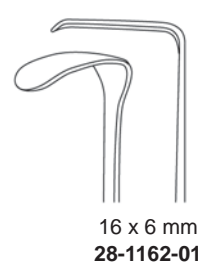

Fig. 2
28-1140-02



LANGENBECK-GREEN
16,0 cm, 6¹/₄"



16 x 6 mm
28-1162-01

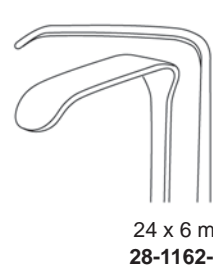

24 x 6 mm
28-1162-02

**Wundhaken
Retractors
Separadores
Divaricatori**



MEYERDING
18,0 cm, 7"



18 x 7 mm
28-1150-01



16 x 5 mm
28-1150-02



7 x 4 mm
28-1150-03



10 x 3 mm
28-1150-04



7 x 4 mm
28-1150-05



4 x 10 mm
28-1150-06



16,0 cm, 6 1/4"



14 x 8 mm
28-1166-16



SENN-GREEN
15,0 cm, 6"



10 x 6 mm
28-1160-10



20 x 6 mm
28-1160-20



MINI-LANGENBECK
16,0 cm, 6 1/4"



10 x 6 mm
28-1164-01



17 x 5 mm
28-1164-02



20 x 6 mm
28-1164-03



22 x 8 mm
28-1164-04



RAGNELL-DAVIS
14,0 cm, 5½"
28-1170-14



RAGNELL
15,0 cm, 6"
28-1174-15

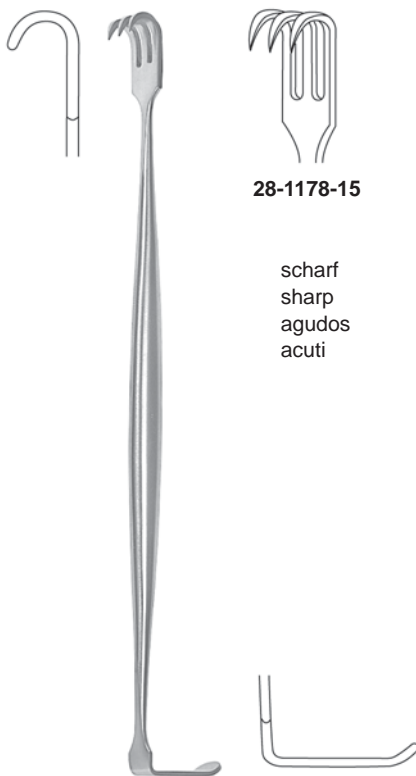

BABY SENN-MILLER
15,0 cm, 6"

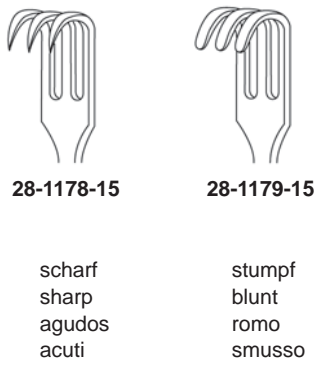

28-1178-15

scharf
sharp
agudos
acuti



28-1179-15

stumpf
blunt
romo
smusso

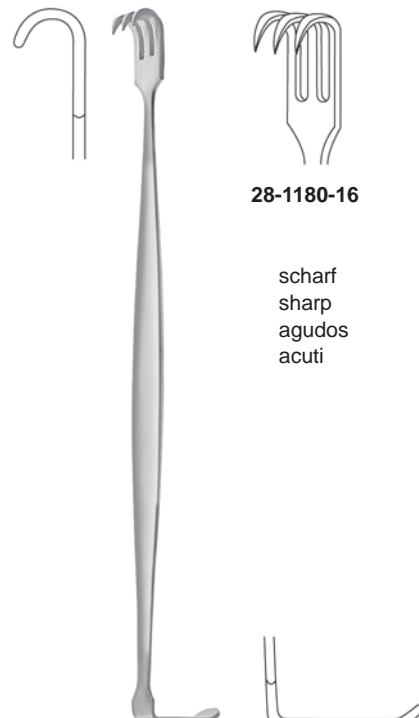

SENN-MILLER
16,0 cm, 6¼"

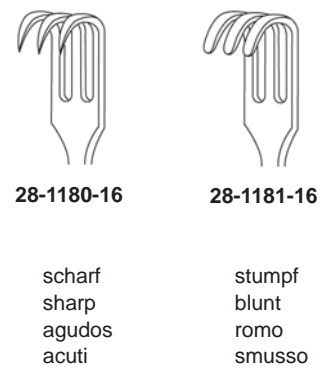

28-1180-16

scharf
sharp
agudos
acuti



28-1181-16

stumpf
blunt
romo
smusso

Wundhaken
Retractors
Separadores
Divaricatori

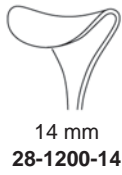

DESMARRES
13,0 cm, 5"

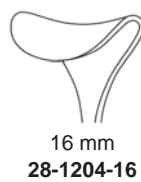
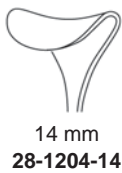
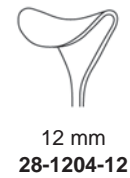

DESMARRES
16,0 cm, 6 1/4"



8 mm
28-1210-08



10 mm
28-1210-10



12 mm
28-1210-12



14 mm
28-1210-14



16 mm
28-1210-16



18 mm
28-1210-18

CUSHING
20,0 cm, 8"



8 mm
28-1212-08



10 mm
28-1212-10



12 mm
28-1212-12



14 mm
28-1212-14



16 mm
28-1212-16



18 mm
28-1212-18

CUSHING
24,0 cm, 9 1/2"

Wundhaken
Retractors
Separadores
Divaricatori



8 mm
28-1220-08



11 mm
28-1220-11



13 mm
28-1220-13



17 mm
28-1220-17



20 mm
28-1220-20



23 mm
28-1220-23

GIL-VERNET
24,0 cm, 9 1/2"



8 mm
28-1230-08



11 mm
28-1230-11



13 mm
28-1230-13



17 mm
28-1230-17



20 mm
28-1230-20



23 mm
28-1230-23

GIL-VERNET
24,0 cm, 9 1/2"



ROUX

- Fig. 1 24 x 20 mm
- Fig. 2 29 x 26 mm
- Fig. 3 33 x 29 mm
- Fig. 4 29 x 24 mm

Satz, Fig. 1-3
Set, fig. 1-3
Juego, fig. 1-3
Serie, fig. 1-3

- Fig. 1 30 x 28 mm
- Fig. 2 36 x 36 mm
- Fig. 3 38 x 43 mm
- Fig. 4 45 x 28 mm

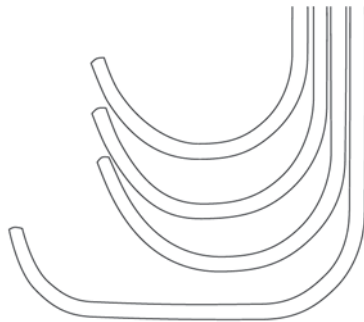
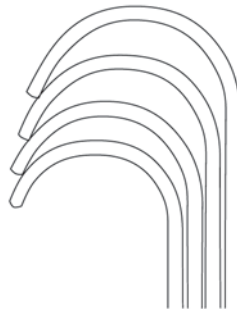
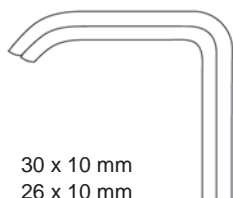

Fig. 1-3	17,0 cm, 6 ³ / ₄ "	28-1310-00
Fig. 1	14,0 cm, 5 ¹ / ₂ "	28-1310-01
Fig. 2	15,0 cm, 6"	28-1310-02
Fig. 3	17,0 cm, 6 ³ / ₄ "	28-1310-03
Fig. 4	18,0 cm, 7"	28-1310-04



FARABEUF
12,0 cm, 4³/₄"
28-1300-12

- Fig. 2 30 x 10 mm
- Fig. 1 26 x 10 mm



- Fig. 1 30 x 13 mm
- Fig. 2 34 x 13 mm

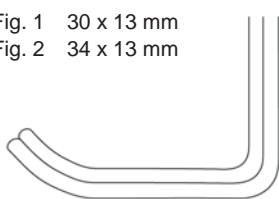

FARABEUF
15,0 cm, 5³/₄"
28-1302-15

- Fig. 2 23 x 16 mm
- Fig. 1 27 x 16 mm

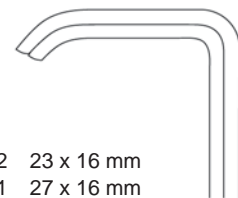

- Fig. 1 26 x 16 mm
- Fig. 2 30 x 16 mm

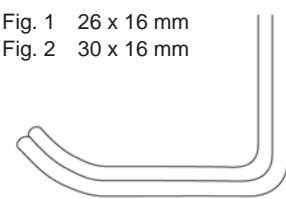

Wundhaken
Retractors
Separadores
Divaricatori



MINI-ROUX
14,0 cm, 5½"
28-1340-06



BABY-ROUX
13,0 cm, 5"
28-1342-13

18 x 17 mm

24 x 21 mm



PARKER
13,5 cm, 5¾"
28-1350-00

Fig. 2 22 x 15 mm
Fig. 1 19 x 15 mm

Fig. 1 19 x 15 mm
Fig. 2 22 x 15 mm

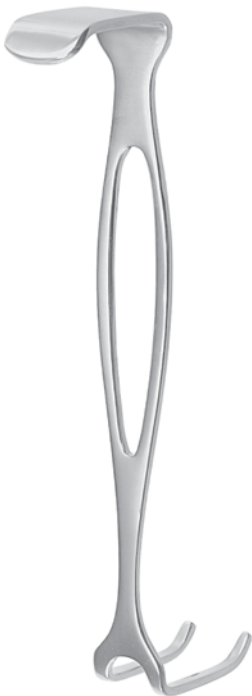

CZERNY
17,5 cm, 7"
28-1360-00

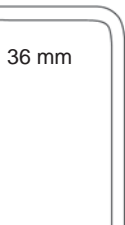

36 mm



38 x 42 mm



MATHIEU
20,0 cm, 8"
28-1380-00

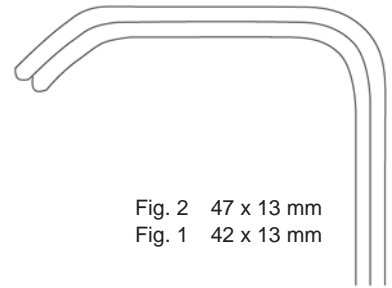

Fig. 2 47 x 13 mm
Fig. 1 42 x 13 mm

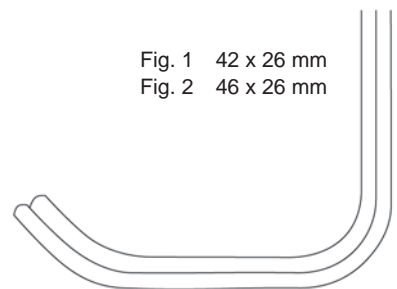

Fig. 1 42 x 26 mm
Fig. 2 46 x 26 mm

**Wundhaken
Retractors
Separadores
Divaricatori**



GOELET
19,0 cm, 7½"
28-1396-19



PARKER-LANGENBECK
21,0 cm, 8¼"
28-1390-00

Fig. 2 25 x 24 mm
Fig. 1 21 x 24 mm

Fig. 1 40 x 15 mm
Fig. 2 45 x 15 mm



CANNY RYAL

16 mm	19,0 cm, 7½"	28-1370-16
20 mm	19,0 cm, 7½"	28-1370-20
25 mm	20,0 cm, 8"	28-1370-25

**Wundhaken
Retractors
Separadores
Divaricatori**



29-1001-01



9 x 8 mm
29-1001-02



9 x 13 mm
29-1001-03



9 x 19 mm
29-1001-04



9 x 29 mm
29-1001-06

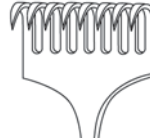

9 x 40 mm
29-1001-08

scharf
sharp
agudos
acuti

VOLKMANN
21,5 cm, 8½"



29-1003-01



9 x 8 mm
29-1003-02



9 x 13 mm
29-1003-03



9 x 19 mm
29-1003-04



9 x 29 mm
29-1003-06

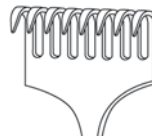

9 x 40 mm
29-1003-08

halbscharf
semi-sharp
semi-agudos
semi-acuti

VOLKMANN
21,5 cm, 8½"



VOLKMANN
21,5 cm, 8½"⁴

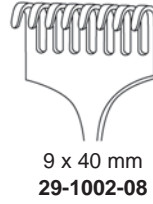
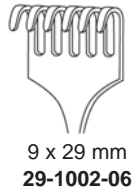
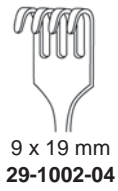
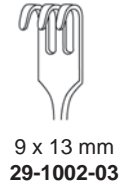
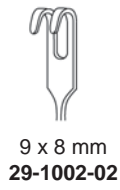

stumpf
blunt
romo
smusso



KOCHER
22,0 cm, 8⅝"⁴

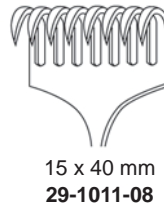
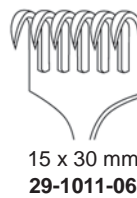
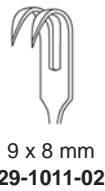

scharf
sharp
agudos
acuti

**Wundhaken
Retractors
Separadores
Divaricatori**



KOCHER
22,0 cm, 8⁵/₈"

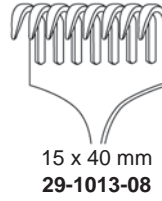
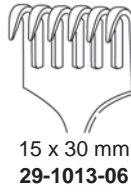
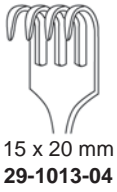
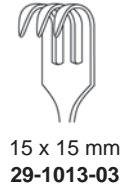
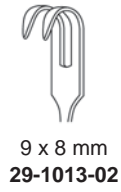

halbscharf
semi-sharp
semi-agudos
semi-acuti



KOCHER
22,0 cm, 8⁵/₈"

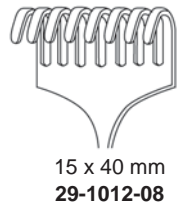
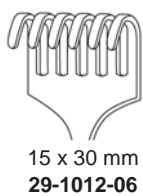
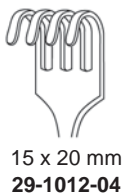
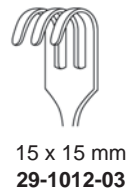
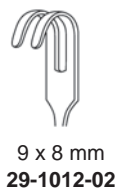

stumpf
blunt
romo
smusso

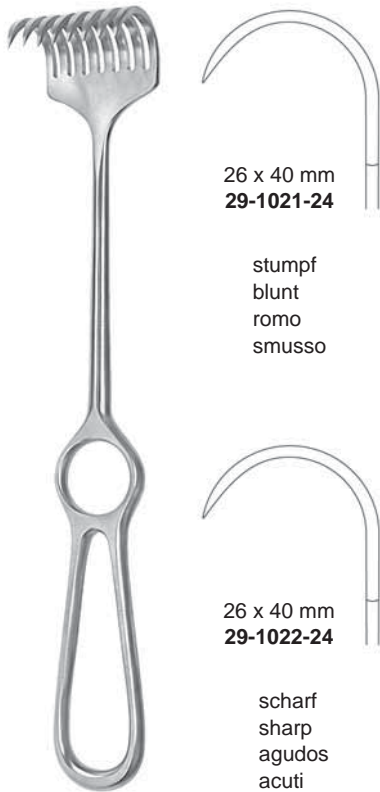

26 x 40 mm
29-1021-24

stumpf
blunt
romo
smusso

26 x 40 mm
29-1022-24

scharf
sharp
agudos
acuti

KOERTE
24,0 cm, 9 1/2"

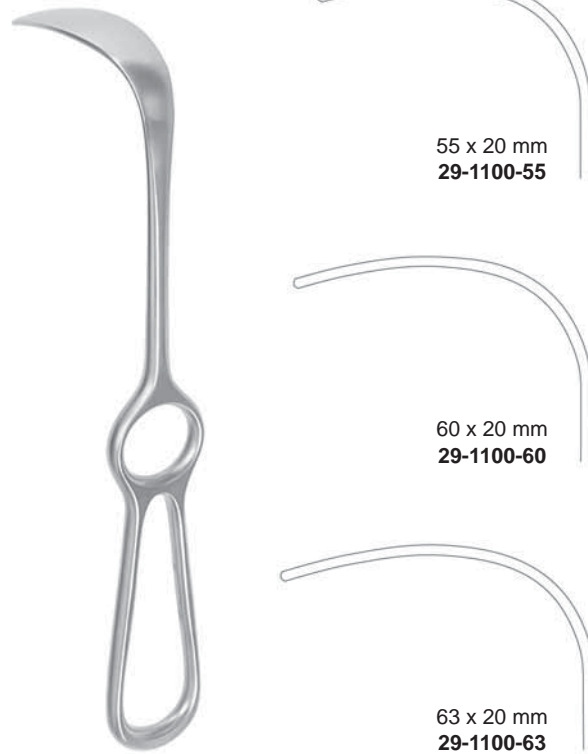

55 x 20 mm
29-1100-55

60 x 20 mm
29-1100-60

63 x 20 mm
29-1100-63

LANGENBECK
21,0 cm, 8 1/4"



ISRAEL
25,0 cm, 9 3/4"

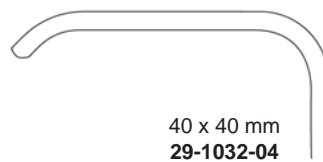

40 x 40 mm
29-1032-04

4 Zähne
4 teeth
4 dientes
4 denti

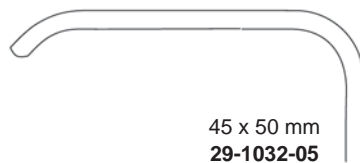

45 x 50 mm
29-1032-05

5 Zähne
5 teeth
5 dientes
5 denti

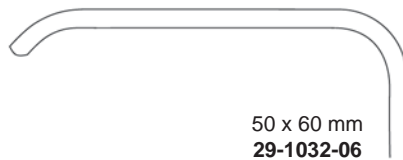

50 x 60 mm
29-1032-06

6 Zähne
6 teeth
6 dientes
6 denti



70 x 70 mm
29-1032-07

6 Zähne
6 teeth
6 dientes
6 denti

Wundhaken
Retractors
Separadores
Divaricatori



LANGENBECK
22,0 cm, 8⁵/₈"

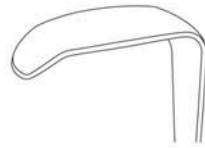

30 x 11 mm
29-1110-30



30 x 14 mm
29-1110-31



30 x 16 mm
29-1110-32



40 x 11 mm
29-1110-40



50 x 11 mm
29-1110-50



LANGENBECK
22,0 cm, 8⁵/₈"



30 x 11 mm
29-1120-30



30 x 14 mm
29-1120-31



30 x 16 mm
29-1120-32



40 x 11 mm
29-1120-40



50 x 11 mm
29-1120-50



KOCHER-LANGENBECK
21,5 cm, 8½"



22 x 6 mm
29-1130-22



25 x 6 mm
29-1130-25



25 x 8 mm
29-1130-26



35 x 8 mm
29-1130-35



35 x 11 mm
29-1130-36



35 x 15 mm
29-1130-37

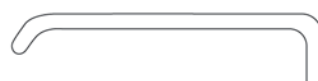

40 x 11 mm
29-1130-40



70 x 14 mm
29-1130-70



80 x 12 mm
29-1130-80



80 x 16 mm
29-1130-85

Wundhaken
Retractors
Separadores
Divaricatori



KOCHER
23,0 cm, 9"

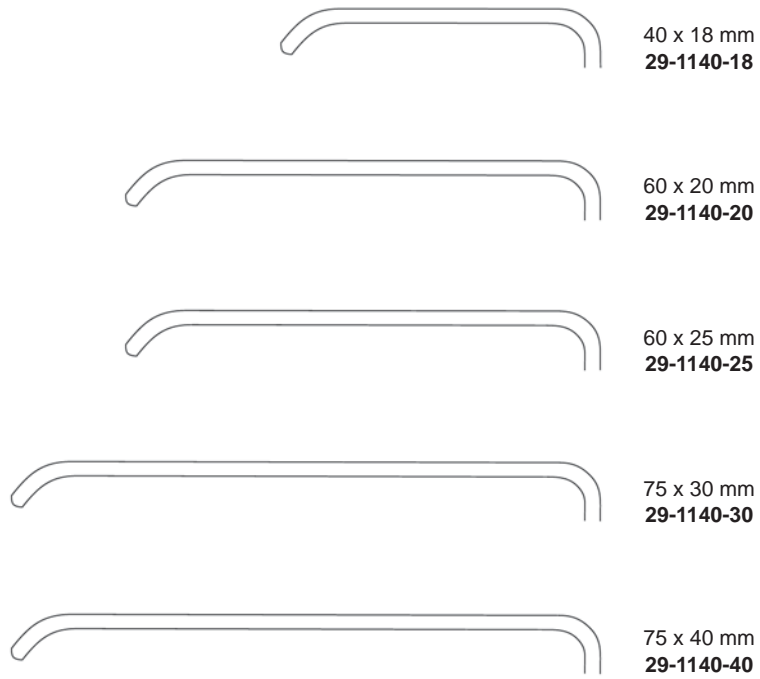

SAUERBRUCH
22,5 cm, 8¾"

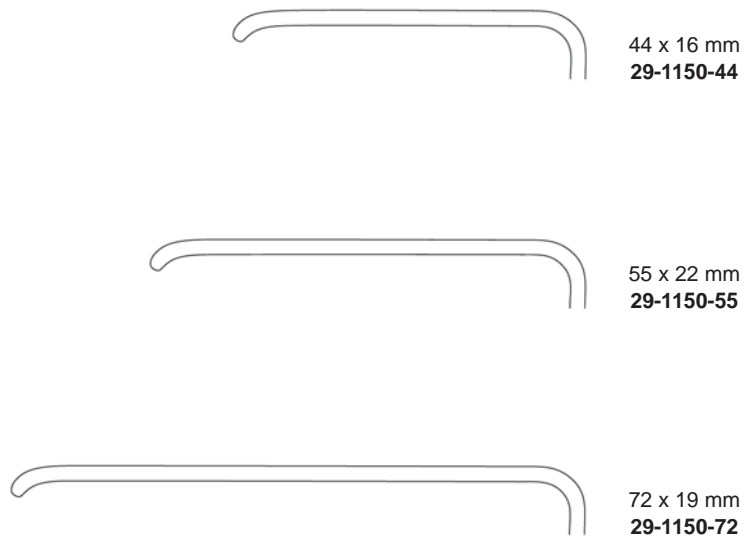



MIDDELDORPF



21,5 cm, 8¹/₂"
14 x 17 mm
29-1180-01

22,0 cm, 8⁵/₈"
20 x 22 mm
29-1180-02

23,5 cm, 9¹/₄"
26 x 30 mm
29-1180-03



MIDDELDORPF



21,5 cm, 8¹/₂"
14 x 17 mm
29-1182-01

22,0 cm, 8⁵/₈"
20 x 22 mm
29-1182-02

23,5 cm, 9¹/₄"
26 x 30 mm
29-1182-03



RICHARDSON (KELLY)
24,0 cm, 9¹/₂"

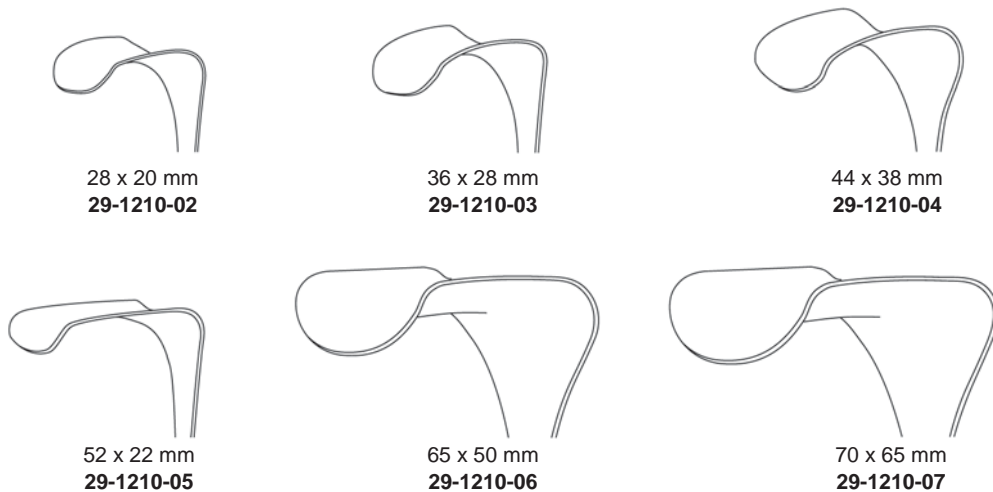

28 x 20 mm
29-1210-02

36 x 28 mm
29-1210-03

44 x 38 mm
29-1210-04

52 x 22 mm
29-1210-05

65 x 50 mm
29-1210-06

70 x 65 mm
29-1210-07

**Wundhaken
Retractors
Separadores
Divaricatori**

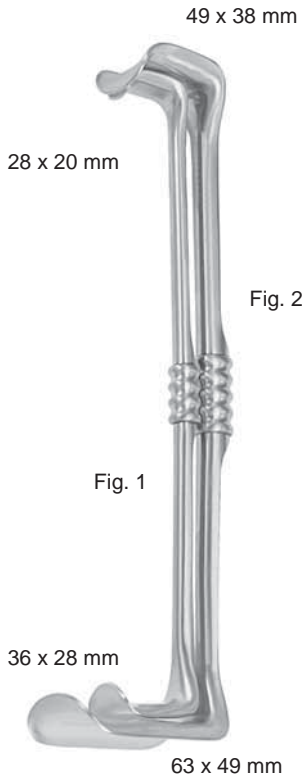
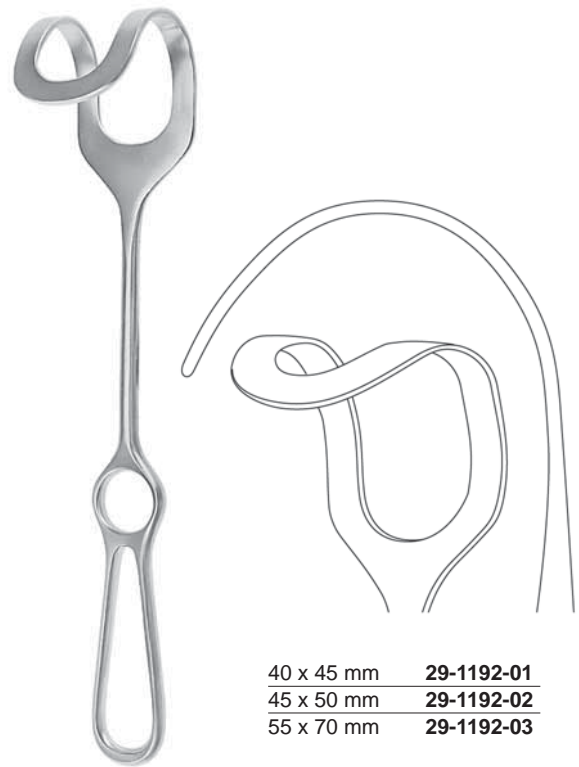

Fig. 1+2	28,0 cm, 11"	28-1200-00
Fig. 1	26,0 cm, 10 ¹ / ₄ "	28-1200-01
Fig. 2	28,0 cm, 11"	28-1200-02

RICHARDSON-EASTMAN



MIDDELDORPF
25,5 cm, 10"



FRITSCH
24,0 cm, 9¹/₂"



DOYEN
25,0 cm, 10"
29-1230-50



DOYEN-STILLE
22,0 cm, 8⁵/₈"

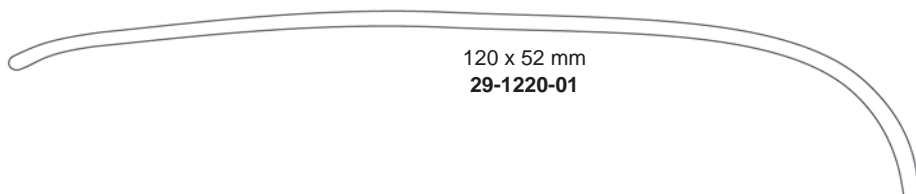

120 x 52 mm
29-1220-01

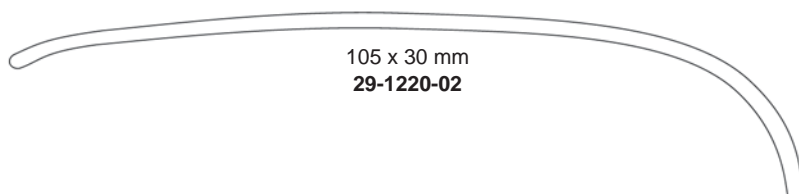

105 x 30 mm
29-1220-02

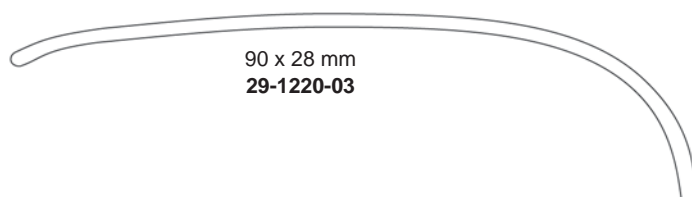

90 x 28 mm
29-1220-03



KOCHER
25,0 cm, 10"

- | | |
|------------|-------------------|
| 70 x 25 mm | 29-1250-70 |
| 80 x 42 mm | 29-1250-81 |
| 80 x 50 mm | 29-1250-82 |
| 80 x 60 mm | 29-1250-83 |

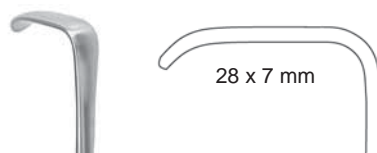

28 x 7 mm



LAHEY
19,0 cm, 7¹/₂"
29-1160-19

**Wundhaken
Retractors
Separadores
Divaricatori**

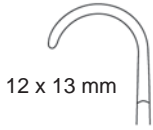

LITTLE
20,0 cm, 8"
29-1164-20



115 x 22 mm **29-1260-01**
115 x 27 mm **29-1260-02**

SIMON
28,0 cm, 11"

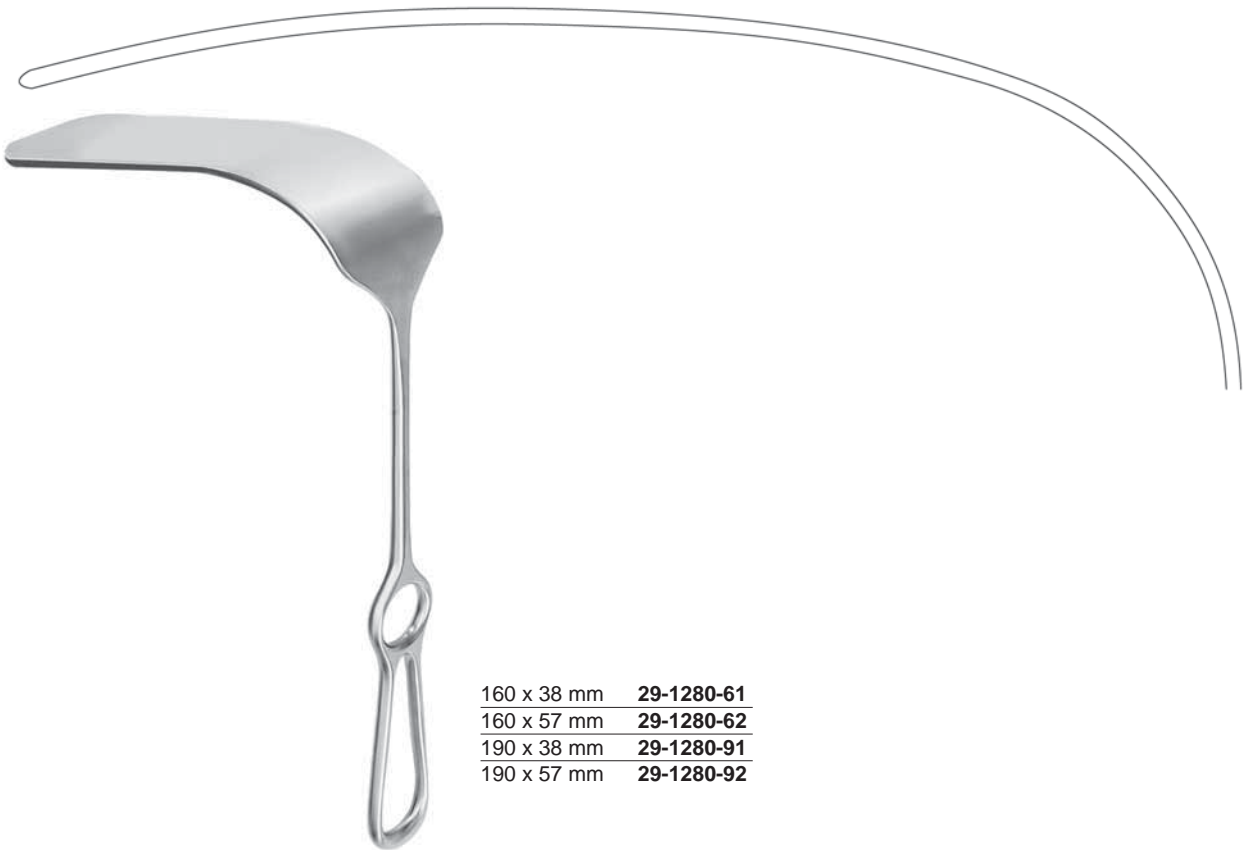

160 x 38 mm **29-1280-61**
160 x 57 mm **29-1280-62**
190 x 38 mm **29-1280-91**
190 x 57 mm **29-1280-92**

KELLY
27,0 cm, 10 1/2"



85 x 35 mm	29-1274-01
120 x 50 mm	29-1274-02
150 x 50 mm	29-1274-03

MIKULICZ
26,0 cm, 10¹/₄"



90 x 50 mm

MIKULICZ
26,0 cm, 10¹/₄"
29-1272-90



70 x 38 mm	29-1290-38
70 x 50 mm	29-1290-51

MORRIS
24,5 cm, 9⁵/₈"

Wundhaken
Retractors
Separadores
Divaricatori

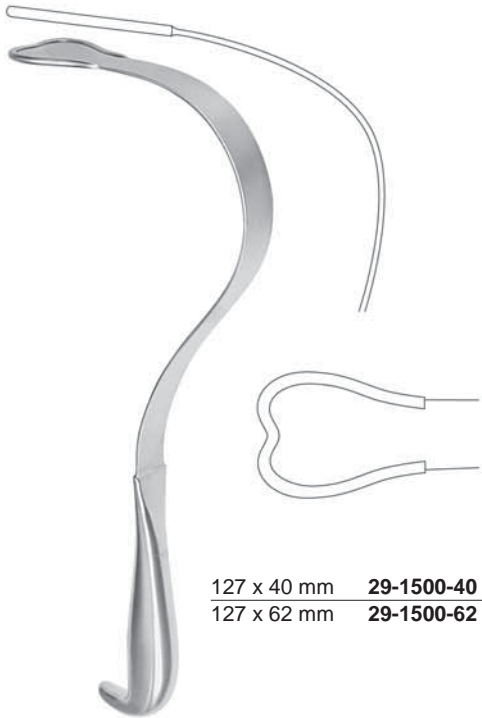

127 x 40 mm **29-1500-40**
127 x 62 mm **29-1500-62**

HARRINGTON
32,0 cm, 12 1/2"



82 x 22 mm **29-1390-01**
108 x 43 mm **29-1390-02**
115 x 65 mm **29-1390-03**

CORYKKOS
24,0 cm, 9 1/2"



ZENKER

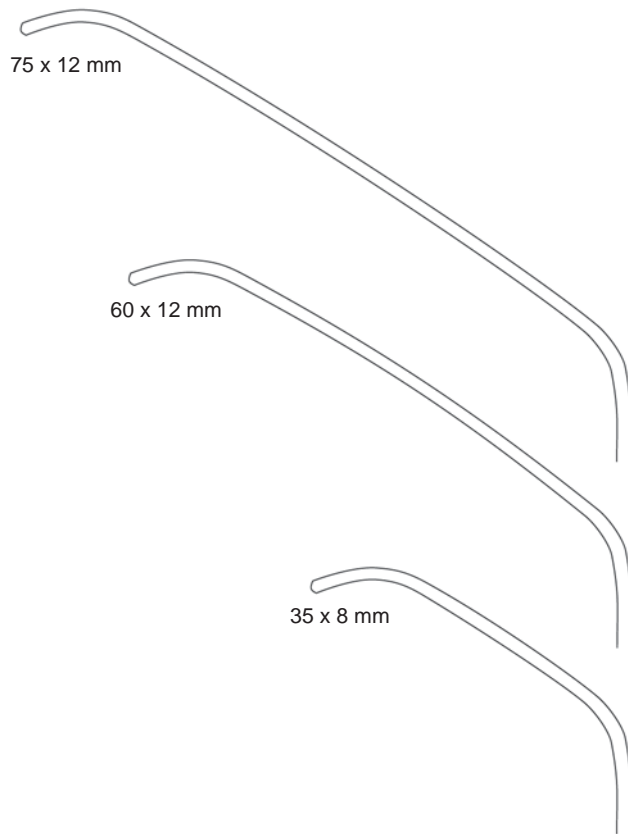

75 x 12 mm

60 x 12 mm

35 x 8 mm

25,0 cm, 9 3/4"
29-1320-25

26,0 cm, 10 1/4"
29-1320-26

27,5 cm, 10 3/4"
29-1320-27



MEYERDING
22,5 cm, 8¾"

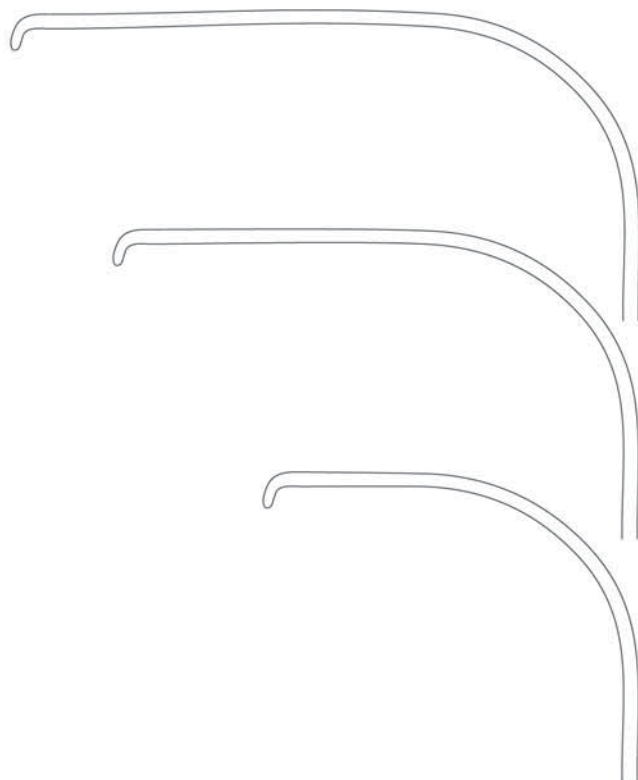

90 x 50 mm
29-1350-50

75 x 25 mm
29-1350-25

50 x 16 mm
29-1350-16



BRUNNER
25,0 cm, 10"

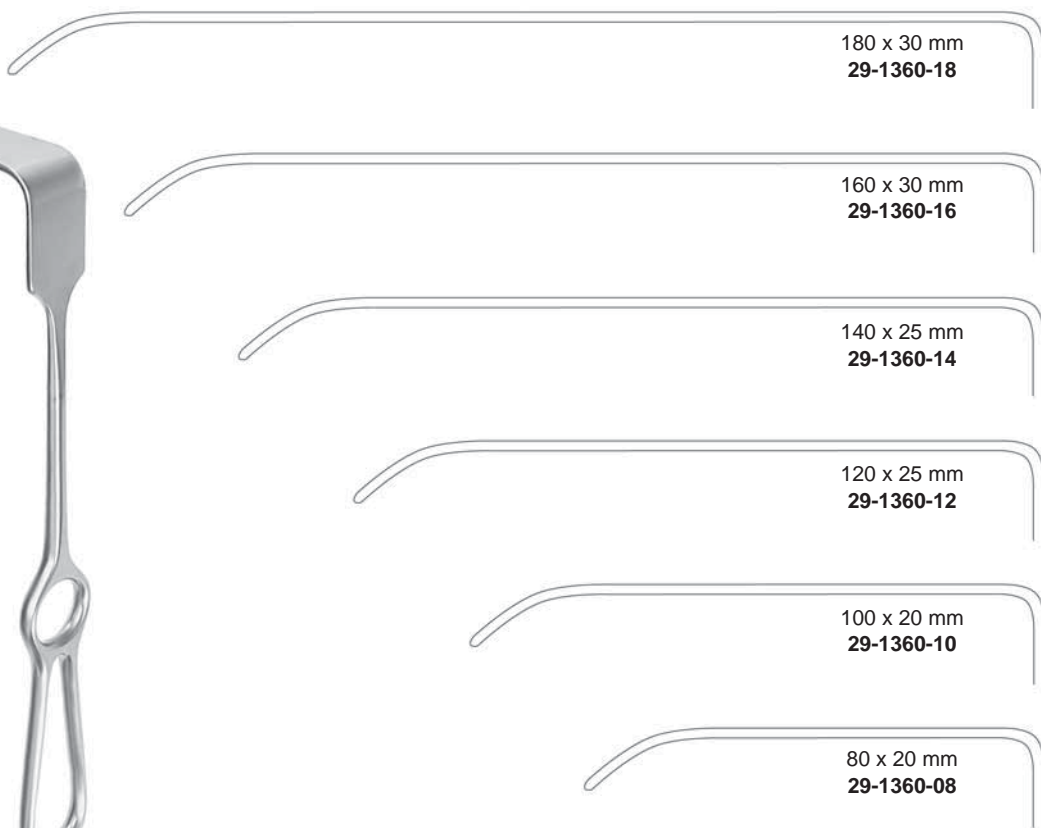

180 x 30 mm
29-1360-18

160 x 30 mm
29-1360-16

140 x 25 mm
29-1360-14

120 x 25 mm
29-1360-12

100 x 20 mm
29-1360-10

80 x 20 mm
29-1360-08

Wundhaken
Retractors
Separadores
Divaricatori



BRUNNER
25,0 cm, 10"

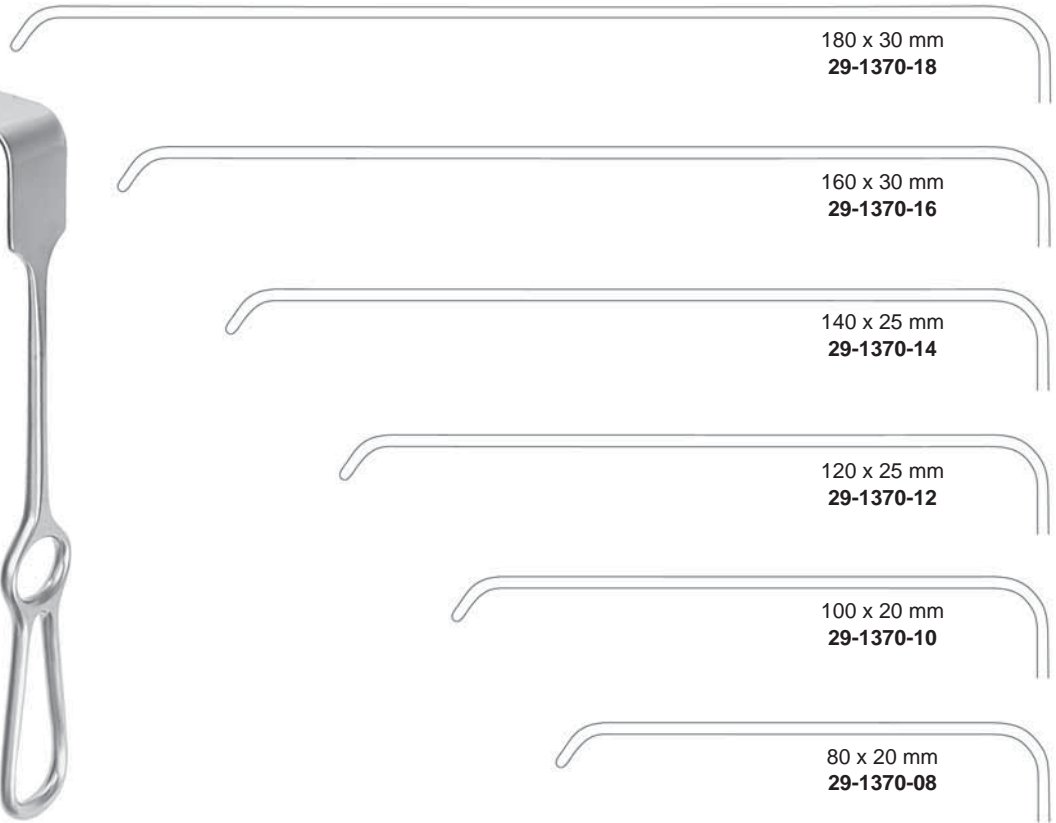

180 x 30 mm
29-1370-18

160 x 30 mm
29-1370-16

140 x 25 mm
29-1370-14

120 x 25 mm
29-1370-12

100 x 20 mm
29-1370-10

80 x 20 mm
29-1370-08



19 mm

DEAVER
18,0 cm, 7"
29-1602-18



22 mm

DEAVER
21,5 cm, 8½"
29-1602-22



25 mm

DEAVER
23,0 cm, 9"
29-1602-23



25 mm

DEAVER
30,0 cm, 11³/₄"
29-1604-30



25 mm

DEAVER
33,0 cm, 13"
29-1604-33



25 mm

DEAVER
36,0 cm, 14¹/₈"
29-1604-36



38 mm

DEAVER
30,0 cm, 11³/₄"
29-1610-38



50 mm

DEAVER
30,0 cm, 11³/₄"
29-1610-50



75 mm

DEAVER
30,0 cm, 11³/₄"
29-1610-75

**Wundhaken
Retractors
Separadores
Divaricatori**



25 mm	29-1600-25
38 mm	29-1600-38
50 mm	29-1600-50
75 mm	29-1600-75

DEAVER
30,0 cm, 11³/₄"



ALLISON

40 mm	30,0 cm, 11 ³ / ₄ "	29-1700-30
54 mm	32,0 cm, 12 ¹ / ₂ "	29-1700-32



DAVIDSON

75 x 50 mm	16,0 cm, 6 ¹ / ₄ "	29-1710-50
75 x 90 mm	16,0 cm, 6 ¹ / ₄ "	29-1710-90



ST MARKS

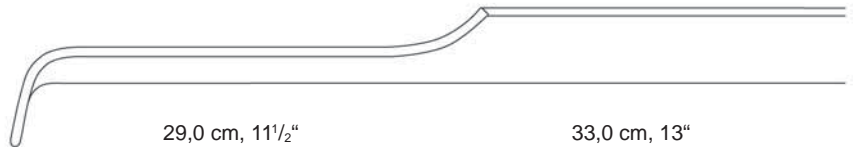

29,0 cm, 11¹/₂"
130 x 60 mm
29-1720-01

33,0 cm, 13"
180 x 60 mm
29-1720-02



29,0 cm, 11¹/₂"
130 x 60 mm
29-1721-01

33,0 cm, 13"
180 x 60 mm
29-1721-02

Wundspreizer
Self-Retaining Retractors
Separadores con retenida automática
Divaricatori autostatici



Wundspreizer
Self-Retaining Retractors
Separadores con retenida automática
Divaricatori autostatici

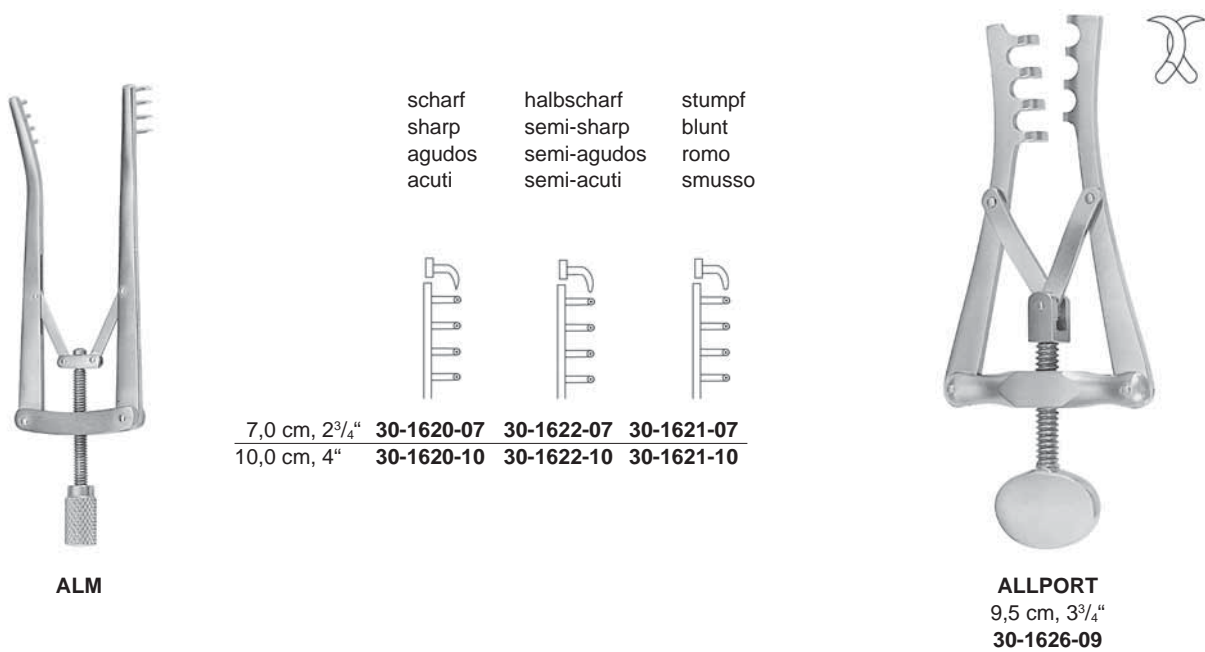
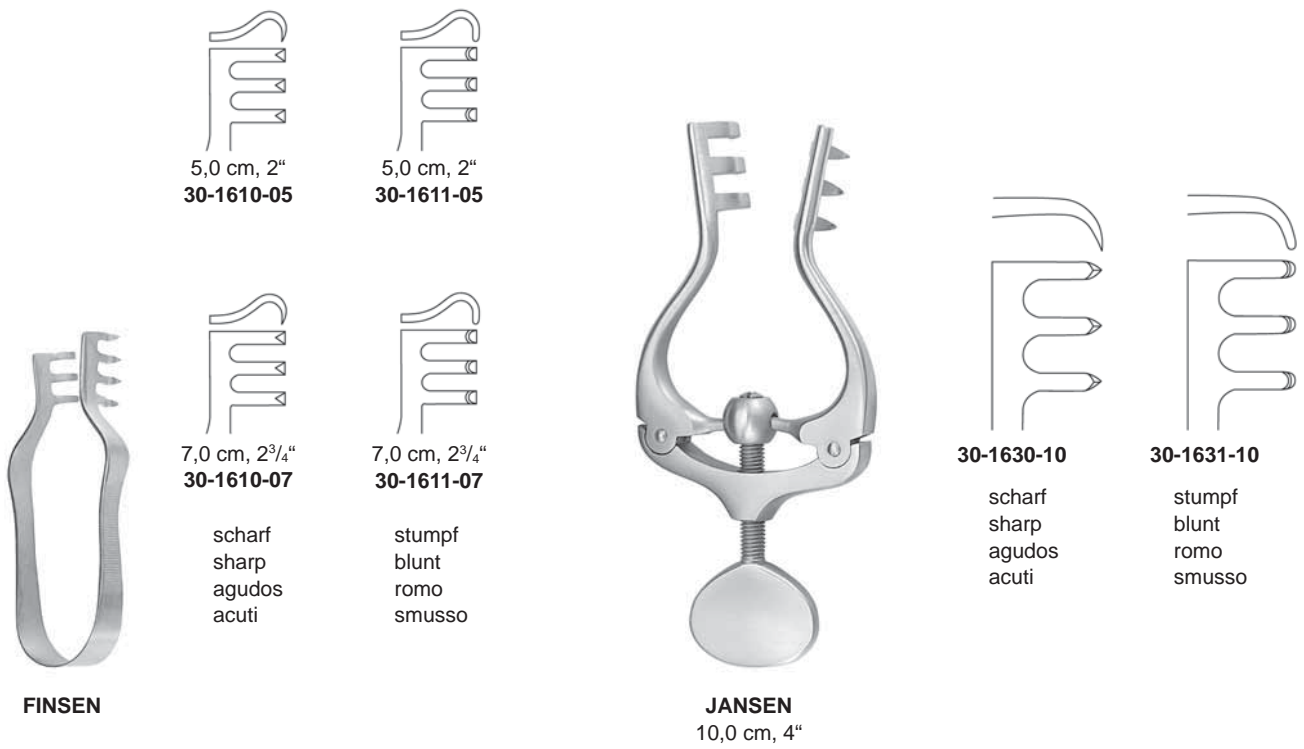

Wundspreizer
 Self-Retaining Retractors
 Separadores con retenida automática
 Divaricatori autostatici

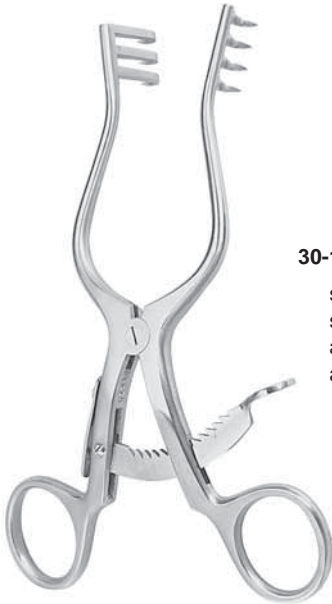

SALP-CONTOUR
 14,0 cm, 5½"



ADSON-BABY
 16,0 cm, 6¼"

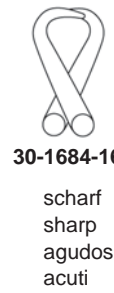

ANDERSON-ADSON
 19,0 cm, 8"



ADSON
 26,5 cm, 10½"

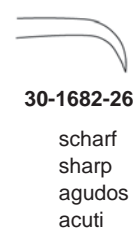

Wundspreizer
 Self-Retaining Retractors
 Separadores con retenida automática
 Divaricatori autostatici



MOLLISON
 15,5 cm, 6"
 30-1674-15



scharf
 sharp
 agudos
 acuti



SCHUHKNECHT
 12,5 cm, 5"



30-1800-12
 scharf
 sharp
 agudos
 acuti



30-1801-12
 stumpf
 blunt
 romo
 smusso



WULLSTEIN



scharf stumpf
 sharp blunt
 agudos romo
 acuti smusso

10,5 cm, 4 ¹ / ₈ "	30-1810-10	30-1811-10
13,0 cm, 5"	30-1810-13	30-1811-13
15,0 cm, 6"	30-1810-15	30-1811-15
18,0 cm, 7"	30-1810-18	30-1811-18



MAYO-ADAMS
 16,5 cm, 6¹/₂"
 30-1822-17

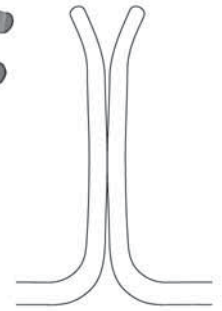

Wundspreizer
Self-Retaining Retractors
Separadores con retenida automática
Divaricatori autostatici



WEITLANER-LOKTITE
 10,5 cm, 4 1/8"



30-1650-10

scharf
 sharp
 agudos
 acuti



30-1651-10

stumpf
 blunt
 romo
 smusso



WEITLANER
 13,0 cm, 5"



30-1670-13

scharf
 sharp
 agudos
 acuti



30-1671-13

stumpf
 blunt
 romo
 smusso



WEITLANER
 16,5 cm, 6 1/2"



30-1670-16

scharf
 sharp
 agudos
 acuti



30-1671-16

stumpf
 blunt
 romo
 smusso



WEITLANER
 20,0 cm, 8"



30-1670-20

scharf
 sharp
 agudos
 acuti



30-1671-20

stumpf
 blunt
 romo
 smusso

Wundspreizer
Self-Retaining Retractors
Separadores con retenida automática
Divaricatori autostatici



WEITLANER
 24,0 cm, 9½"



30-1670-24
 scharf
 sharp
 agudos
 acuti



30-1671-24
 stumpf
 blunt
 romo
 smusso



PLESTER
 13,0 cm, 5"



30-1830-13
 scharf
 sharp
 agudos
 acuti



30-1831-13
 stumpf
 blunt
 romo
 smusso



MILLIGAN
 13,0 cm, 5"
30-1840-13

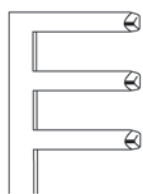

PLESTER
 11,0 cm, 4¾"
30-1672-11

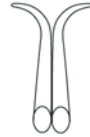

PLESTER
 11,0 cm, 4¾"
30-1673-11

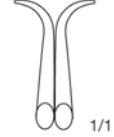

Wundspreizer
Self-Retaining Retractors
Separadores con retenida automática
Divaricatori autostatici



WEITLANER-BABY
 13,0 cm, 5"
 30-1850-13



**ADSON
 (CONE)**

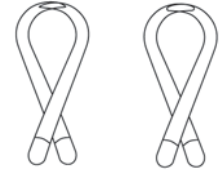

20,0 cm, 8"	30-1860-20	30-1861-20
26,0 cm, 10 ¹ / ₄ "	30-1860-26	30-1861-26

scharf	stumpf
sharp	blunt
agudos	romo
acuti	smusso



GELPI
 13,5 cm, 5³/₈"
 30-1202-14



GELPI
 19,0 cm, 7¹/₂"
 30-1202-19



GELPI-LOKTITE
 18,0 cm, 7¹/₂"
 30-1250-19

Wundspreizer
 Self-Retaining Retractors
 Separadores con retenida automática
 Divaricatori autostatici

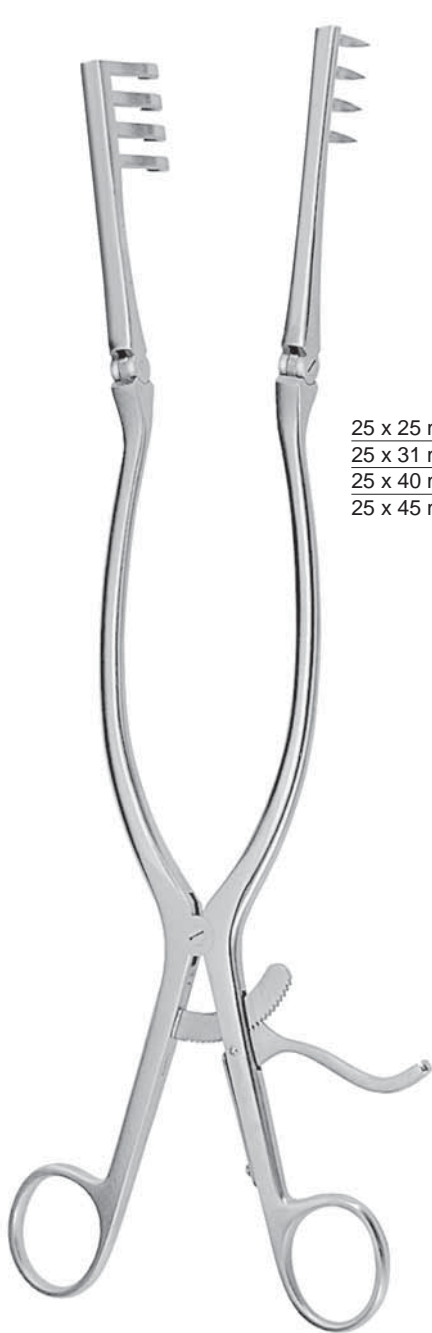

BECKMANN-ADSON
 31,0 cm, 12 1/4"

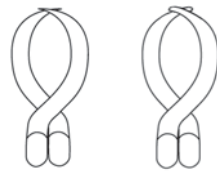

25 x 25 mm	30-1870-01	30-1871-01
25 x 31 mm	30-1870-02	30-1871-02
25 x 40 mm	30-1870-03	30-1871-03
25 x 45 mm	30-1870-04	30-1871-04

scharf	stumpf
sharp	blunt
agudos	romo
acuti	smusso

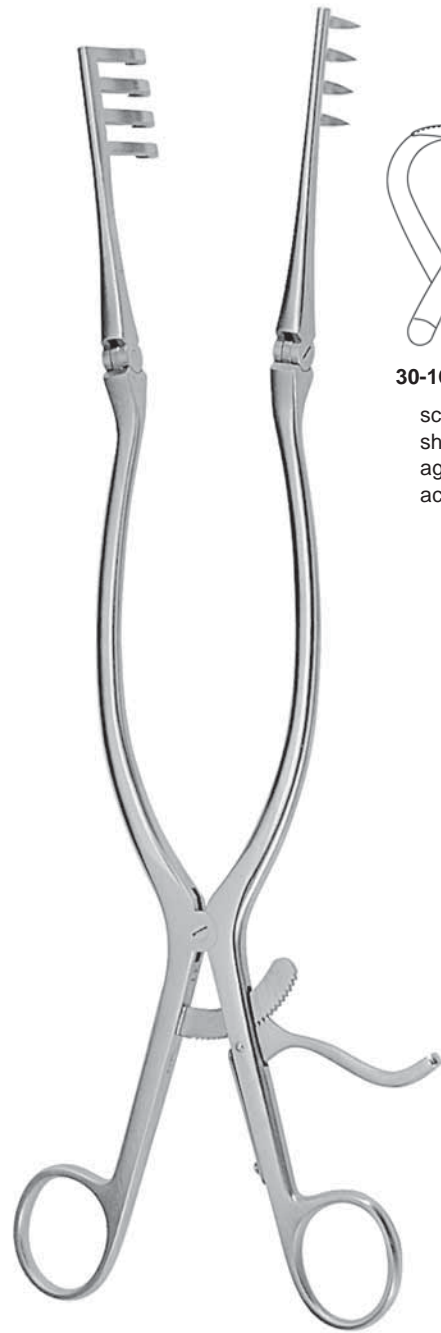

BECKMANN
 31,0 cm, 12 1/4"



30-1690-31

scharf
 sharp
 agudos
 acuti



BECKMANN
32,0 cm, 12½"



30-1691-32

stumpf
blunt
romo
smusso



10,0 cm, 4" **30-1240-10**
14,0 cm, 5½" **30-1240-14**

DE BAKEY

Wundspreizer
 Self-Retaining Retractors
 Separadores con retenida automática
 Divaricatori autostatici



NORFOLK AND NORWICH
 22,0 cm, 8⁵/₈"
 30-1401-22



stumpf
 blunt
 romo
 smusso



JACKSON BURROWS
 17,5 cm, 7"
 30-1411-17



stumpf
 blunt
 romo
 smusso



RICHTER
 17,0 cm, 6³/₄"
 30-1420-17



JOLL (FRIEDMAN)
 15,5 cm, 6"
 30-1430-15

**Wundspreizer
Self-Retaining Retractors
Separadores con retenida automática
Divaricatori autostatici**



scharf
sharp
agudos
acuti

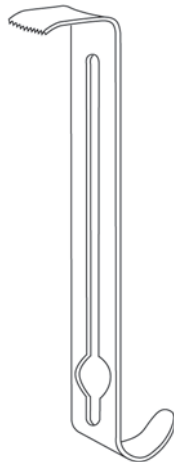

19 x 16 mm
30-1300-19

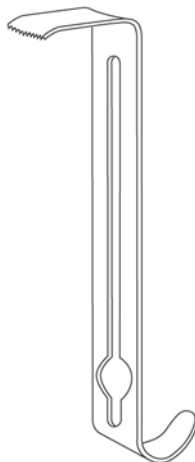

25 x 16 mm
30-1300-25

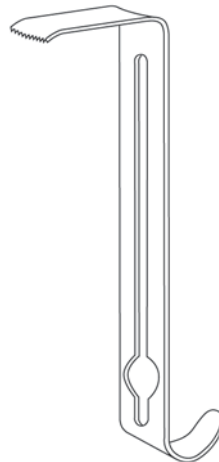

32 x 16 mm
30-1300-32



stumpf
blunt
romos
smusso

HENLEY
16,0 cm, 6¹/₄"
30-1300-16

HENLEY
16,0 cm, 6¹/₄"
30-1301-16

**HENLEY
30-1300-00**

komplett, bestehend aus:

- 1 Sperrer mit Seitenvalven, scharf (30-1300-16)
- 1 Mittelvalve 19 x 16 mm (30-1300-19)
- 1 Mittelvalve 25 x 16 mm (30-1300-25)
- 1 Mittelvalve 32 x 16 mm (30-1300-32)

complete, consisting of:

- 1 Spreader with lateral valves, sharp (30-1300-16)
- 1 Central valve 19 x 16 mm (30-1300-19)
- 1 Central valve 25 x 16 mm (30-1300-25)
- 1 Central valve 32 x 16 mm (30-1300-32)

completo, compuesto of:

- 1 Separador con valvas laterales, agudas (30-1300-16)
- 1 Valva central 19 x 16 mm (30-1300-19)
- 1 Valva central 25 x 16 mm (30-1300-25)
- 1 Valva central 32 x 16 mm (30-1300-32)

completo, composto da:

- 1 Divaricatore con valve laterali, acuto (30-1300-16)
- 1 Valva centrale 19 x 16 mm (30-1300-19)
- 1 Valva centrale 25 x 16 mm (30-1300-25)
- 1 Valva centrale 32 x 16 mm (30-1300-32)

**HENLEY
30-1301-00**

komplett, bestehend aus:

- 1 Sperrer mit Seitenvalven, stumpf (30-1301-16)
- 1 Mittelvalve 19 x 16 mm (30-1300-19)
- 1 Mittelvalve 25 x 16 mm (30-1300-25)
- 1 Mittelvalve 32 x 16 mm (30-1300-32)

complete, consisting of:

- 1 Spreader with lateral valves, blunt (30-1301-16)
- 1 Central valve 19 x 16 mm (30-1300-19)
- 1 Central valve 25 x 16 mm (30-1300-25)
- 1 Central valve 32 x 16 mm (30-1300-32)

completo, compuesto of:

- 1 Separador con valvas laterales, romas (30-1301-16)
- 1 Valva central 19 x 16 mm (30-1300-19)
- 1 Valva central 25 x 16 mm (30-1300-25)
- 1 Valva central 32 x 16 mm (30-1300-32)

completo, composto da:

- 1 Divaricatore con valve laterali, smusso (30-1301-16)
- 1 Valva centrale 19 x 16 mm (30-1300-19)
- 1 Valva centrale 25 x 16 mm (30-1300-25)
- 1 Valva centrale 32 x 16 mm (30-1300-32)

Wundspreizer, Bauchdeckenhalter
 Self-Retaining Retractors, Abdominal Retractors
 Separadores con retenida automática, Separadores abdominales
 Divaricatori autostatici, Divaricatori addominali



MAYO-ADAMS
 17,0 cm, 6³/₄"
 30-1320-17



COLLIN-BABY
 18,0 cm, 7"
 30-1330-18

30 x 44 mm
 30-1330-30



23 x 44 mm
 30-1330-23

Wechselvalven
 Exchangeable blades
 Valvas intergambiabili
 Valve intercambiabili



RICARD
 28,0 cm, 11"
 31-1310-28



RICARD
 30,0 cm, 12"
 31-1312-30

Wundspreizer, Bauchdeckenhalter
Self-Retaining Retractors, Abdominal Retractors
Separadores con retenida automática, Separadores abdominales
Divaricatori autostatici, Divaricatori addominali



COLLIN
 23,5 cm, 9 1/4"
31-1330-24

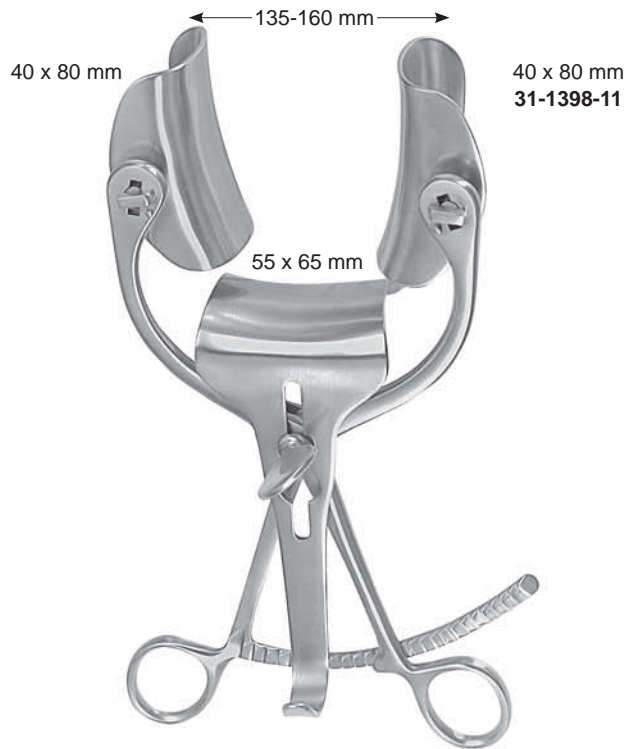

COLLIN
 23,5 cm, 9 1/4"
31-1332-24



COLLIN
 23,5 cm, 9 1/4"
31-1334-24

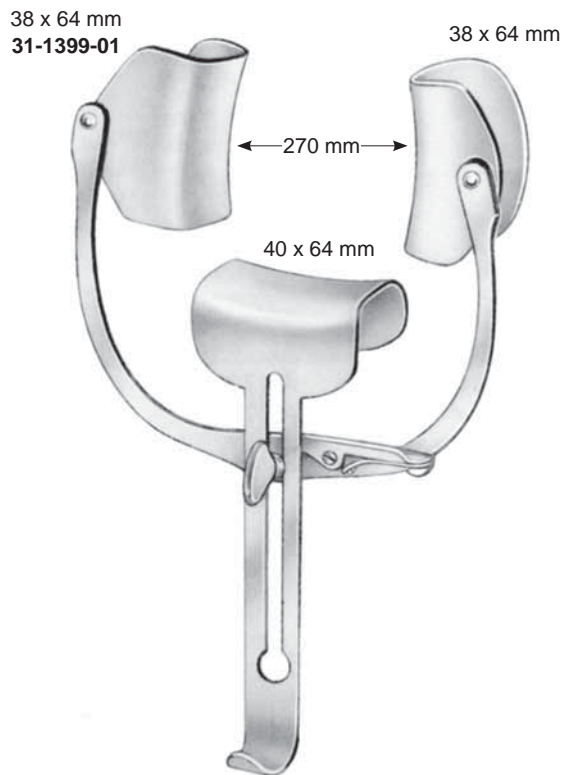

ROBIN-MASSÉ
31-1360-27

Wundspreizer, Bauchdeckenhalter
Self-Retaining Retractors, Abdominal Retractors
Separadores con retenida automática, Separadores abdominales
Divaricatori autostatici, Divaricatori addominali



38 x 62 mm **31-1399-01**
 40 x 80 mm **31-1399-02**
 60 x 80 mm **31-1399-03**

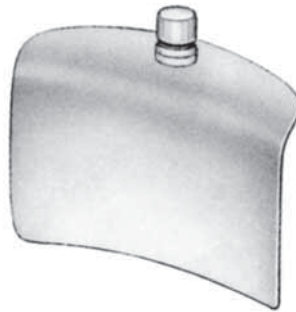

50 x 58 mm **31-1399-10**
 60 x 80 mm **31-1399-13**
 72 x 85 mm **31-1399-14**



31-1399-23
 60 x 80 mm

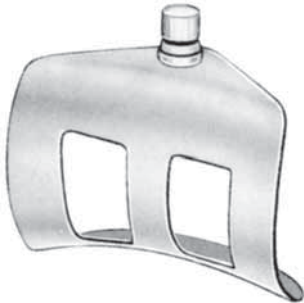

31-1399-33
 60 x 80 mm



58 x 50 mm **31-1398-01**
 80 x 60 mm **31-1398-02**
 85 x 72 mm **31-1398-03**



62 x 38 mm **31-1398-10**
 80 x 38 mm **31-1398-11**
 100 x 38 mm **31-1398-12**
 80 x 38 mm **31-1398-13**



COLLIN
 55 x 55 mm **31-1331-01**
 55 x 65 mm **31-1331-02**
 55 x 75 mm **31-1331-03**



ROBIN-MASSE
 40 x 64 mm **31-1360-01**
 55 x 65 mm **31-1360-02**
 55 x 75 mm **31-1360-03**



RICARD
 65 x 50 mm **31-1310-01**
 70 x 55 mm **31-1310-02**
 90 x 80 mm **31-1310-03**

Bauchdeckenhalter
Abdominal Retractors
Separadores abdominales
Divaricatori addominali

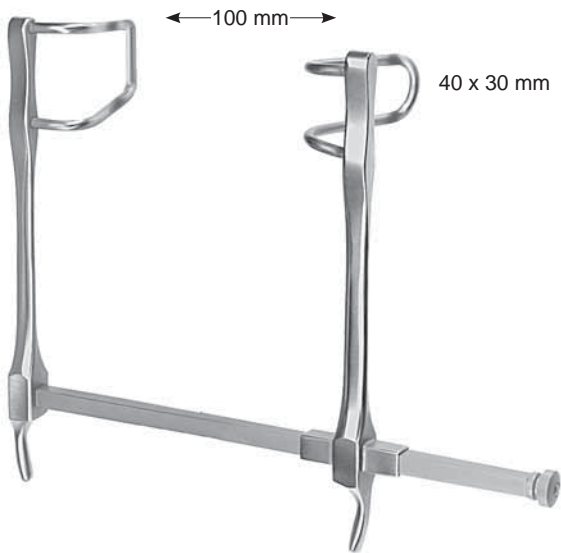

GOSSET
31-1400-10

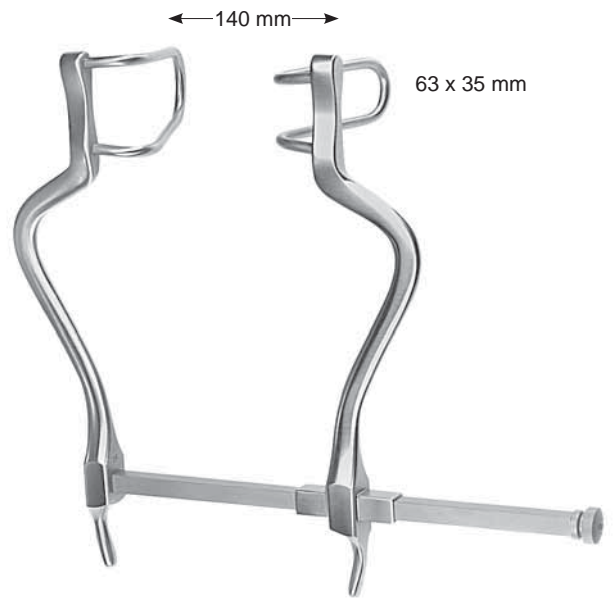

GOSSET
31-1412-14

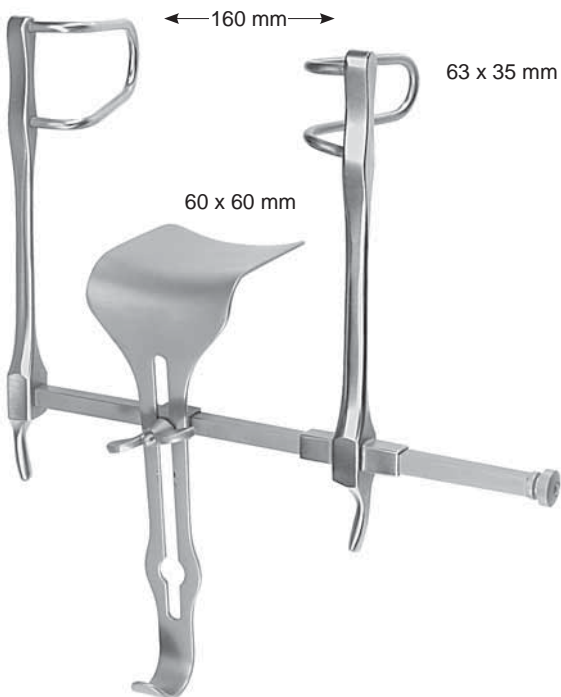

GOSSET
31-1414-16



ABADIE
31-1450-12

Bauchdeckenhalter
Abdominal Retractors
Separadores abdominales
Divaricatori addominali

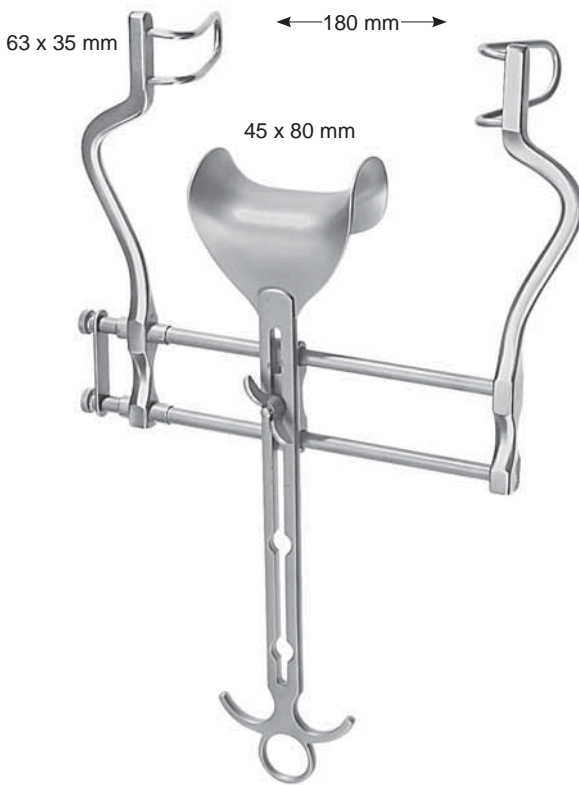

BALFOUR
31-1764-18

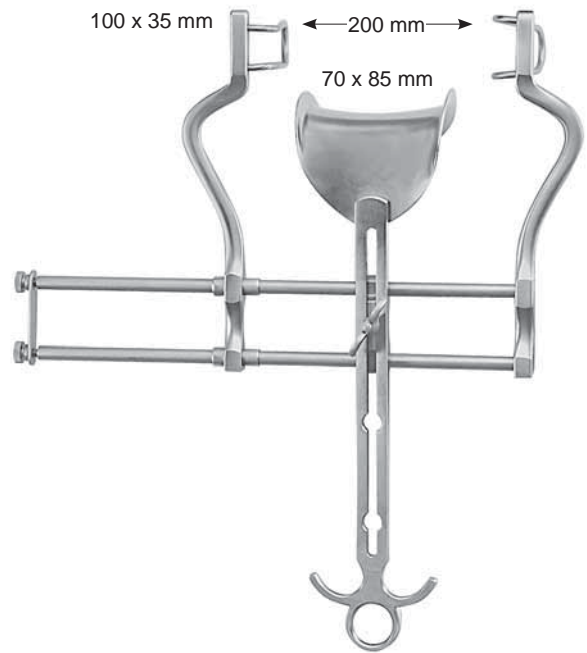

BALFOUR
31-1768-20

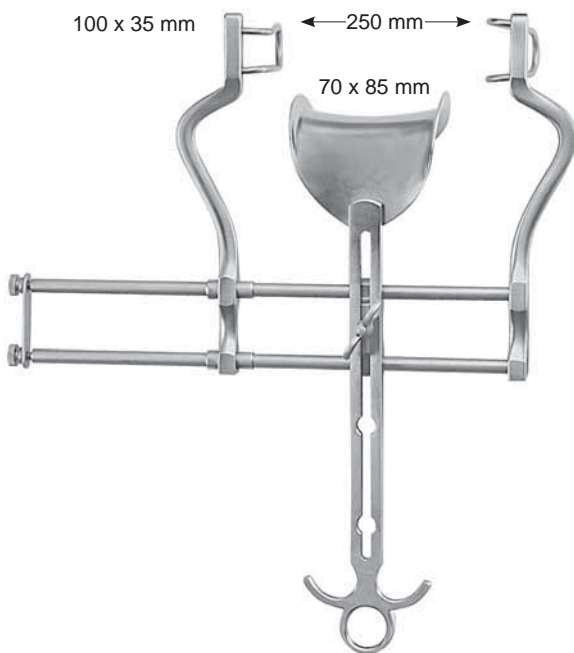

BALFOUR
31-1768-25

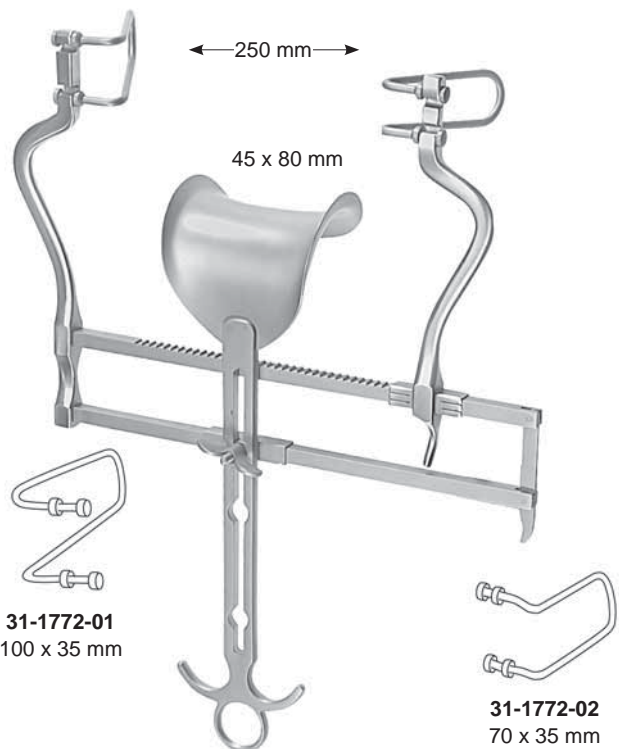

BALFOUR US-TYPE
31-1772-25

31-1772-01
100 x 35 mm

31-1772-02
70 x 35 mm

Bauchdeckenhalter
Abdominal Retractors
Separadores abdominales
Divaricatori addominali

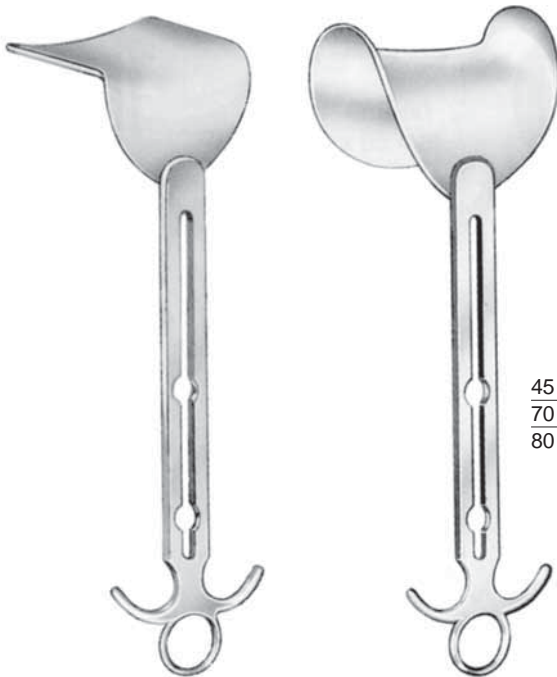

BALFOUR
100 x 70 mm
31-1799-70

BALFOUR

45 x 80 mm **31-1798-01**
70 x 85 mm **31-1798-02**
80 x 90 mm **31-1798-03**

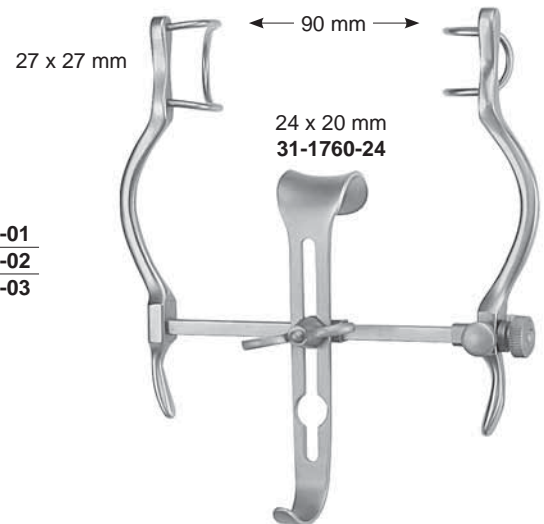

BALFOUR
31-1760-09

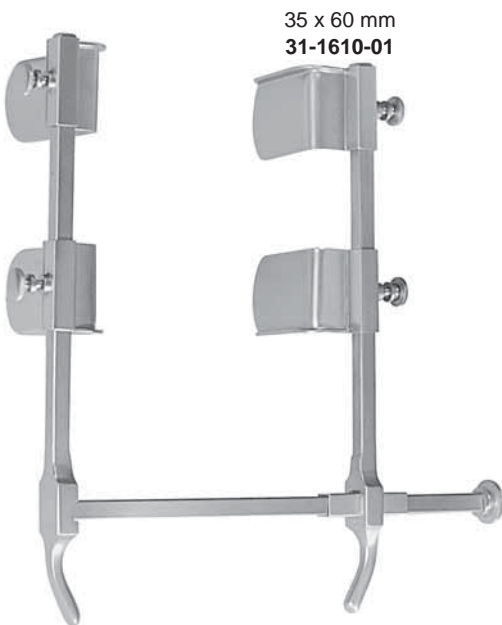

BERKELEY
31-1610-00

35 x 60 mm
31-1610-01

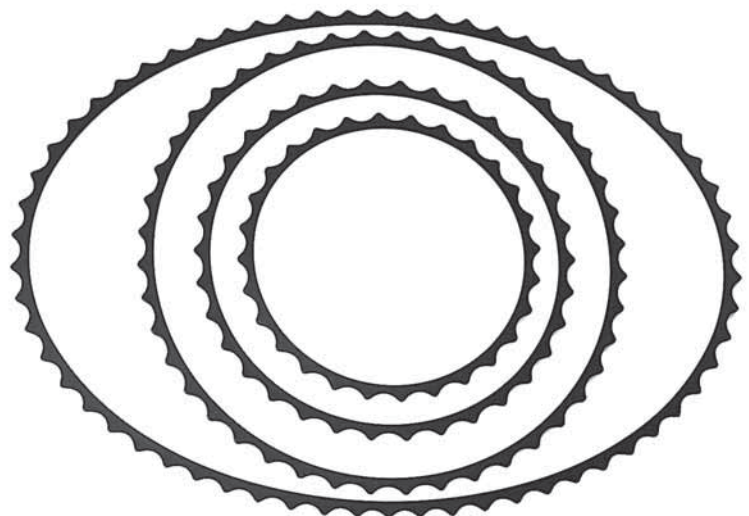

Ø 180 mm, 7" **31-1850-18**
Ø 230 mm, 9" **31-1850-23**
Ø 305 mm, 12" **31-1850-30**
455 x 330 mm **31-1850-45**

Bauchdeckenhalter
Abdominal Retractors
Separadores abdominales
Divaricatori addominali

geschwärzt, black finish, negra, nera



31-1859-01
13 mm



31-1859-02
51 x 38 mm



31-1859-03
70 x 60 mm



31-1859-04
89 x 60 mm



31-1859-05
114 x 60 mm

geschwärzt, black finish, negra, nera



31-1859-06
19 x 76 mm



31-1859-07
38 x 102 mm



31-1859-08
57 x 89 mm



31-1859-09
57 x 114 mm

31-1860-11
 40 x 30 mm

31-1860-22
 40 x 40 mm



40 x 30 mm

40 x 40 mm

31-1860-01
 255 x 180 mm
 Rahmen allein
 frame only
 cuadro suelto
 solo telaio

DENNIS BROWN
 255 x 180 mm
31-1860-00
 komplett
 complete
 completo
 completo

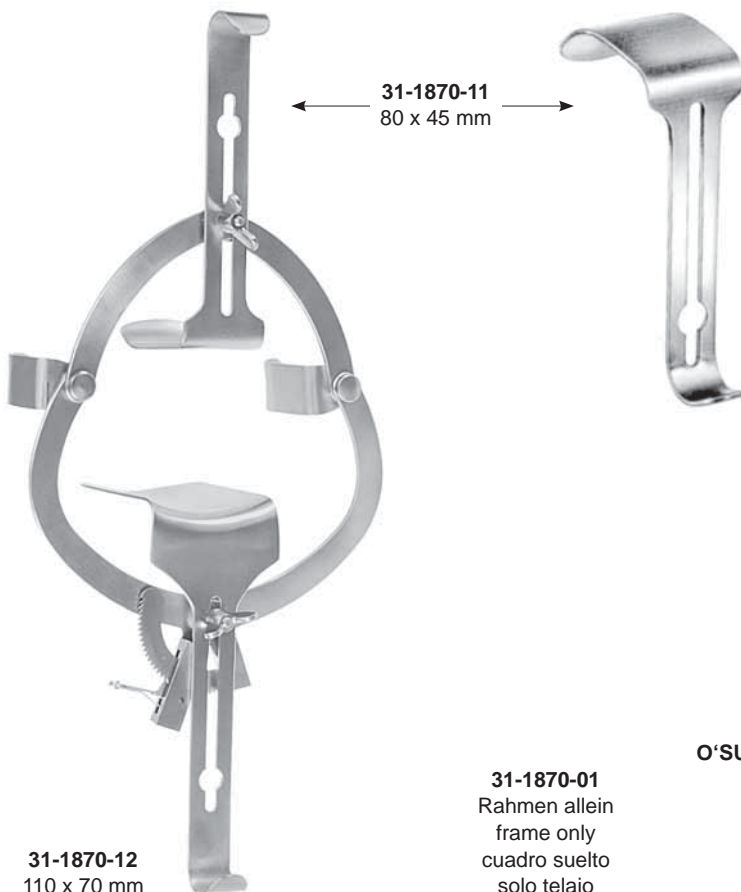

31-1870-11
 80 x 45 mm

31-1870-12
 110 x 70 mm

31-1870-01
 Rahmen allein
 frame only
 cuadro suelto
 solo telaio

O'SULLIVAN-O'CONNOR
31-1870-00
 komplett
 complete
 completo
 completo

Bauchdeckenhalter
Abdominal Retractors
Separadores abdominales
Divaricatori addominali

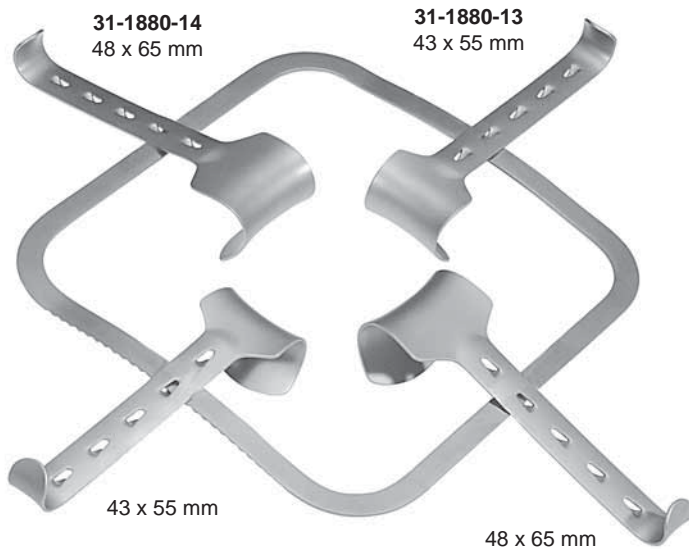

31-1880-01 250 x 250 mm
31-1880-02 300 x 320 mm
31-1880-03 300 x 380 mm
 Rahmen allein
 frame only
 cuadro suelto
 solo telaio

KIRSCHNER
31-1880-00
 komplett
 complete
 completo
 completo
 1 x 31-1880-01
 2 x 31-1880-13
 2 x 31-1880-14



31-1882-01
 255 x 255 mm
 zusammenlegbarer Rahmen, allein
 folding frame, only
 cuadro plegable, suelto
 telaio pieghevole, solo

KIRSCHNER
31-1882-00
 komplett
 complete
 completo
 completo
 1 x 31-1882-01
 2 x 31-1880-13
 2 x 31-1880-14



43 x 55 mm	31-1880-13
48 x 65 mm	31-1880-14
80 x 90 mm	31-1880-15
90 x 65 mm	31-1880-16
98 x 95 mm	31-1880-17

KIRSCHNER



KIRSCHNER
 60 x 82 mm
 31-1880-11



KIRSCHNER-BALFOUR
 83 x 82 mm
 31-1880-12



KIRSCHNER
 98 x 51 mm 31-1880-20
 105 x 38 mm 31-1880-21

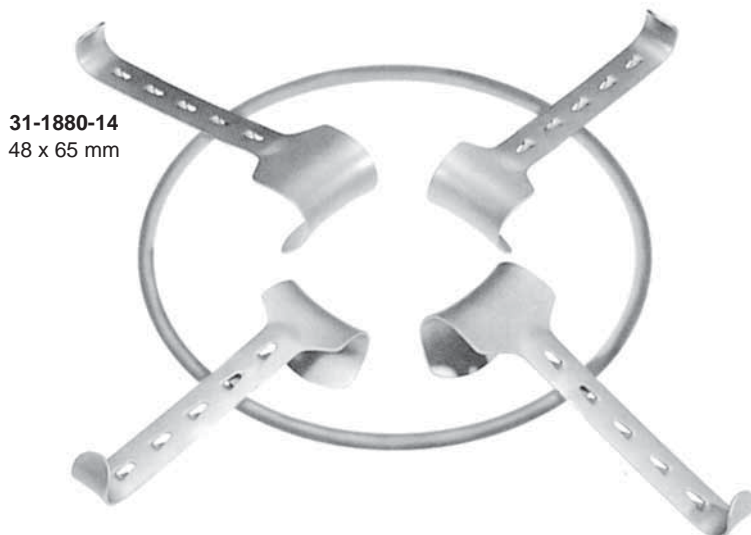

31-1880-14
 48 x 65 mm

31-1890-00
 300 x 240 mm
 Rahmen allein
 frame only
 cuadro suelto
 solo telaio

31-1880-15
 80 x 90 mm

KIRSCHNER, oval
31-1884-00
 komplett, complete, completo, completo
 1 x 31-1884-01
 3 x 31-1880-14
 1 x 31-1880-15
 1 x 31-1880-20
 1 x 31-1880-21

Bauchdeckenhalter
Abdominal Retractors
Separadores abdominales
Divaricatori addominali

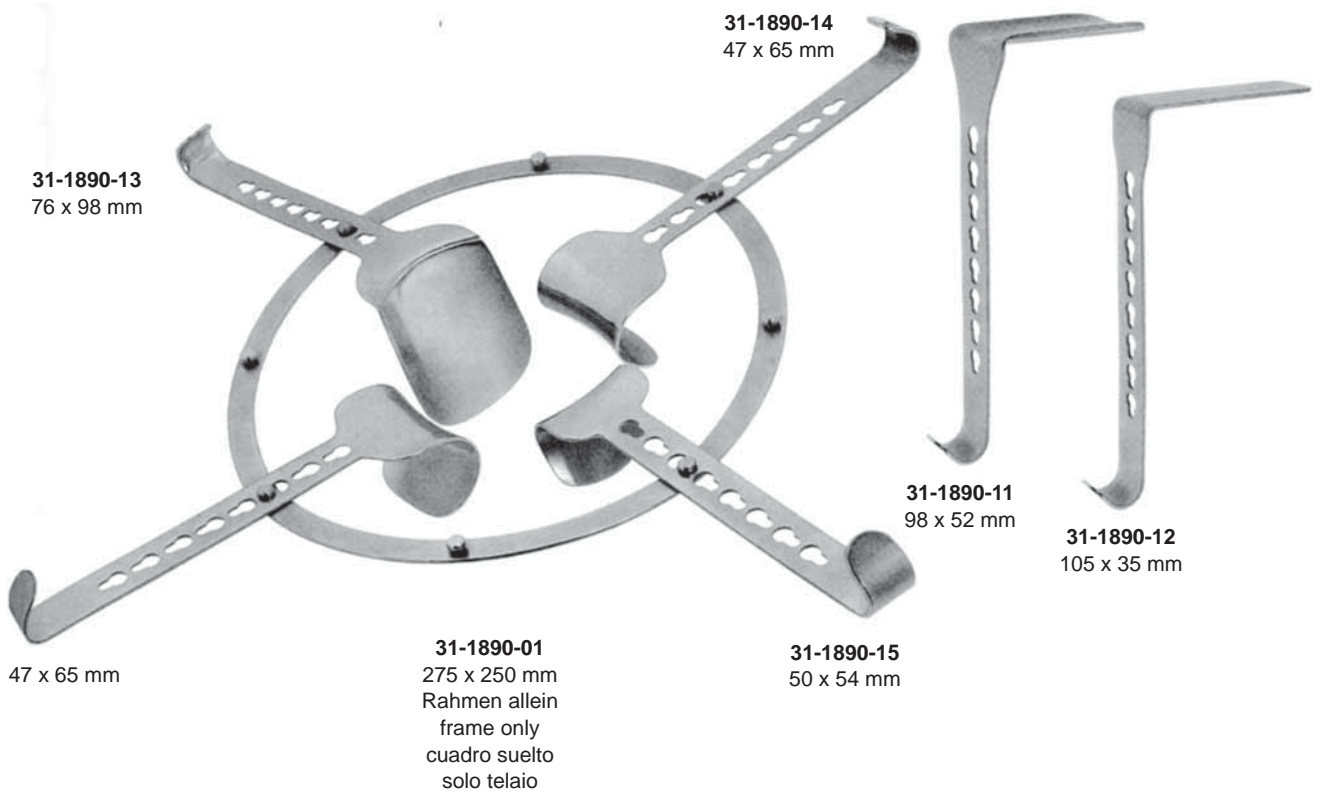

31-1890-13
76 x 98 mm

31-1890-14
47 x 65 mm

31-1890-11
98 x 52 mm

31-1890-12
105 x 35 mm

47 x 65 mm

31-1890-01
275 x 250 mm
Rahmen allein
frame only
cuadro suelto
solo telaio

31-1890-15
50 x 54 mm

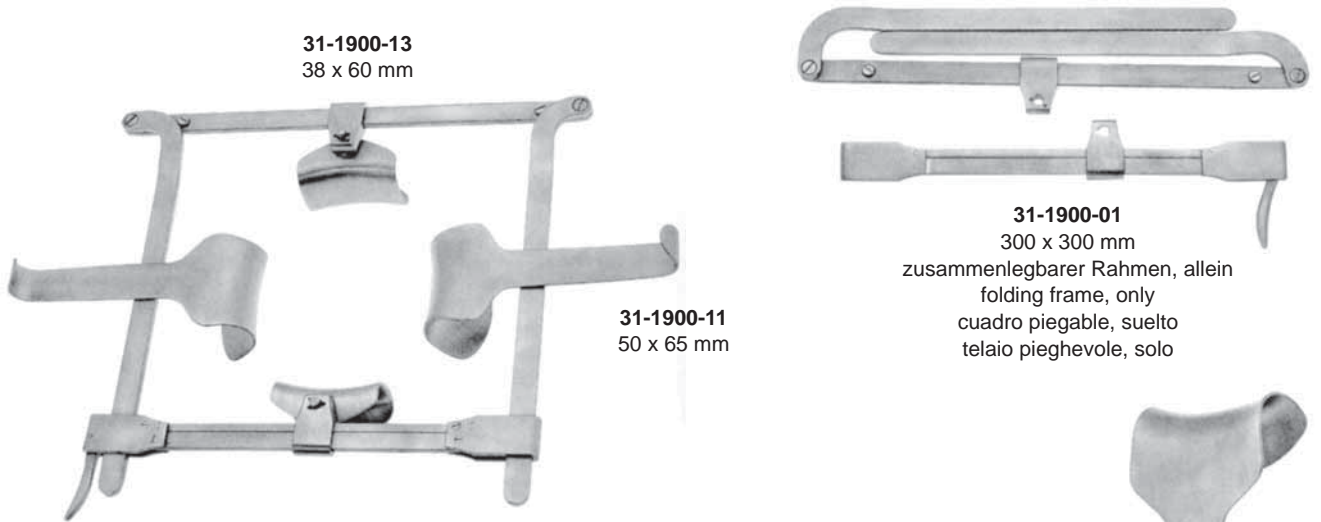

31-1900-13
38 x 60 mm

31-1900-11
50 x 65 mm

31-1900-01
300 x 300 mm
zusammenlegbarer Rahmen, allein
folding frame, only
cuadro plegable, suelto
telaio pieghevole, solo

FRANZ
31-1900-00
 komplett
 complete
 completo
 completo
 1 x 31-1900-01
 2 x 31-1900-11
 2 x 31-1900-13

38 x 60 mm **31-1900-13**
45 x 80 mm **31-1900-14**

50 x 65 mm **31-1900-11**
60 x 85 mm **31-1900-12**

**Bauchdeckenhalter
Abdominal Retractors
Separadores abdominales
Divaricatori addominali**

für / for / para / per
31-1910-11
31-1910-14



95 x 60 mm	31-1910-11
105 x 65 mm	31-1910-12
115 x 65 mm	31-1910-13
125 x 65 mm	31-1910-14

DOYEN
28,0 cm, 11"



Kette mit Gewicht
Chain with weight
Catena con pesa
Catena con peso

31-1915-30
78,5 cm, 31"



53,0 cm, 21"
66,0 cm, 26"

Befestigungsgestell
Mounting frame
Bastidor para la fijación
Telaio di supporto per il fissaggio

ROCHARD
31-1920-01



53,0 cm, 21"
66,0 cm, 26"

Befestigungsgestell
Mounting frame
Bastidor para la fijación
Telaio di supporto per il fissaggio

ROCHARD
31-1920-02

95 x 48 mm	31-1920-10
105 x 48 mm	31-1920-12
115 x 48 mm	31-1920-13
125 x 48 mm	31-1920-14
155 x 48 mm	31-1920-16



ROCHARD
28,0 cm, 11"
31-1920-20

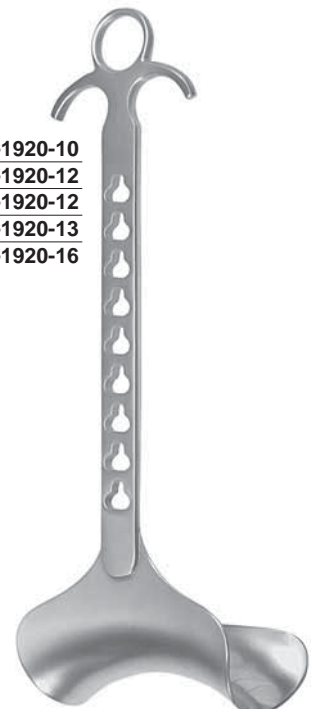

ROCHARD
28,0 cm, 11"

Bauchspatel
Abdominal Spatulas
Espátulas abdominales
Spatole addominali



biegsam
 malleable
 maleable
 malleabile

200 x 6 mm **32-1210-06**
200 x 12 mm **32-1210-12**
200 x 17 mm **32-1210-17**
200 x 20 mm **32-1210-20**
200 x 25 mm **32-1210-25**

RIBBON



biegsam
 malleable
 maleable
 malleabile

280 x 25/30 mm **32-1200-01**
300 x 37/45 mm **32-1200-02**
300 x 40/50 mm **32-1200-03**

RIBBON



biegsam
 malleable
 maleable
 malleabile

330 x 13 mm **32-1170-13**
330 x 25 mm **32-1170-25**
330 x 32 mm **32-1170-32**
330 x 40 mm **32-1170-40**
330 x 50 mm **32-1170-50**

RIBBON



biegsam
 malleable
 maleable
 malleabile

TUFFIER
 200 x 25/17 mm
32-1220-20



REVERDIN
 280 x 45/60 mm
32-1230-28

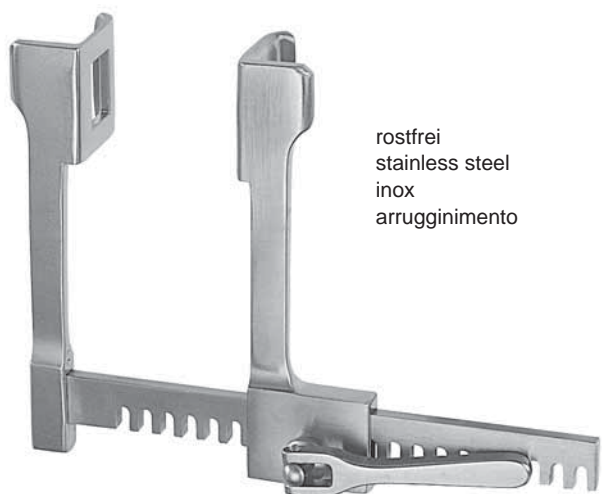

rostfrei
stainless steel
inox
arrugginimento

a	b	c	
18 mm	20 mm	75 mm	47-1100-01

FINOCCHIETTO-BABY

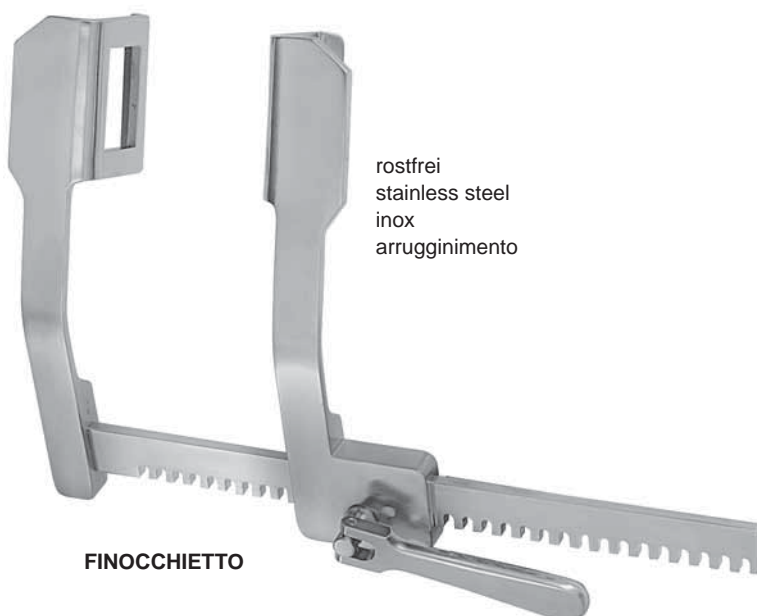

rostfrei
stainless steel
inox
arrugginimento

a	b	c	
40 mm	40 mm	165 mm	47-1100-02
45 mm	65 mm	200 mm	47-1100-03
70 mm	65 mm	250 mm	47-1100-04

FINOCCHIETTO



rostfrei
stainless steel
inox
arrugginimento

a	b	c	
50 mm	45 mm	165 mm	47-1150-01

TUFFIER

Sonden, Trokare
Probes, Trocars
Sondas, Trócares
Sonde, Trequarti

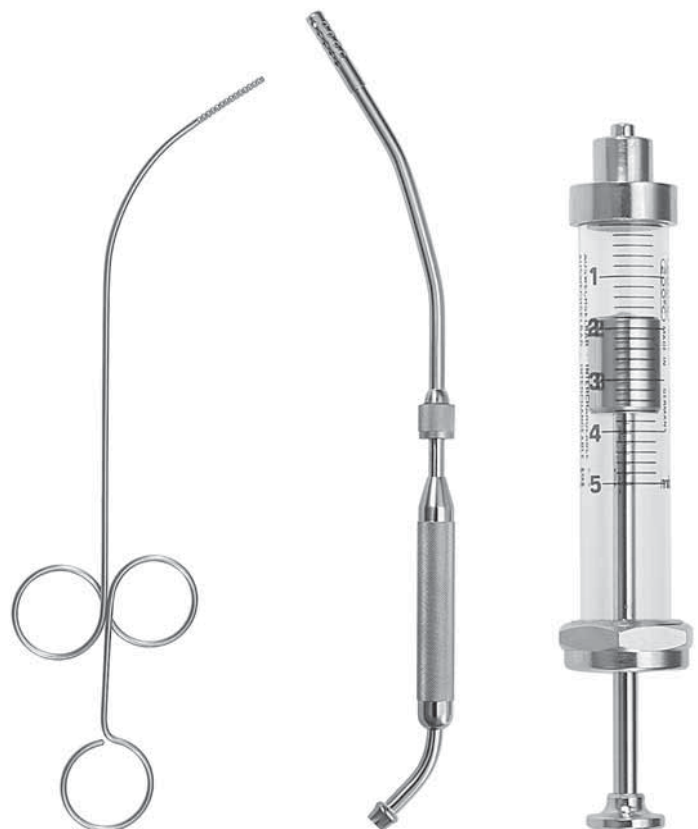

Sonden
Probes
Sondas
Sonde

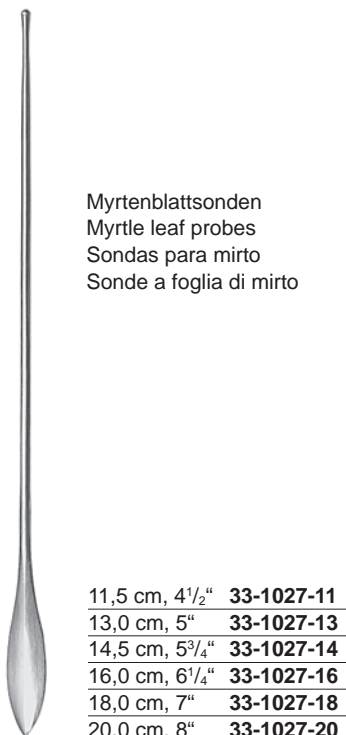
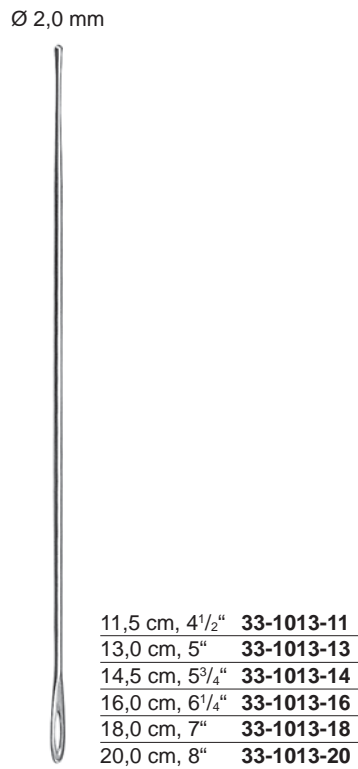
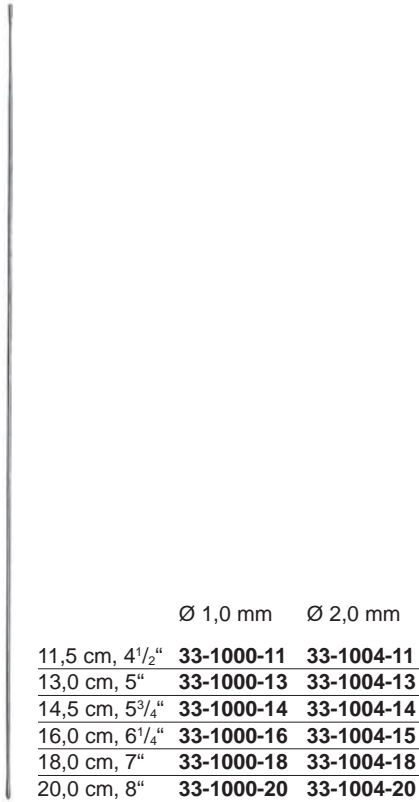

Ø 3,5 mm



11,5 cm, 4 1/2"	33-1110-11
13,0 cm, 5"	33-1110-13
14,5 cm, 5 3/4"	33-1110-14
16,0 cm, 6 1/4"	33-1110-16
18,0 cm, 7"	33-1110-18
20,0 cm, 8"	33-1110-20

Ø 3,3 mm



13,0 cm, 5"	33-1122-13
14,5 cm, 5 3/4"	33-1122-14
16,0 cm, 6 1/4"	33-1122-16
18,0 cm, 7"	33-1122-18



LOCKHART-MUMMERY
16,5 cm, 6 1/2"
33-1130-01



LOCKHART-MUMMERY
16,5 cm, 6 1/2"
33-1130-02

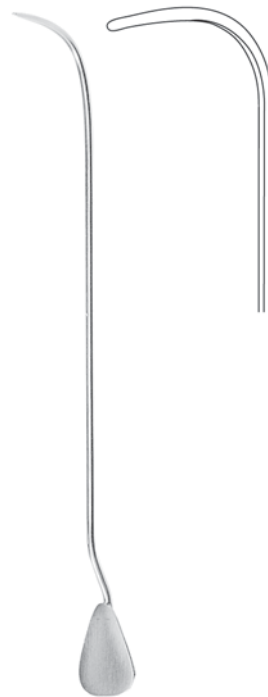

LOCKHART-MUMMERY
16,5 cm, 6 1/2"
33-1130-03



LOCKHART-MUMMERY
16,5 cm, 6 1/2"
33-1130-04

Watteträger
Cotton Applicators
Porta-algodones
Porta-cotone

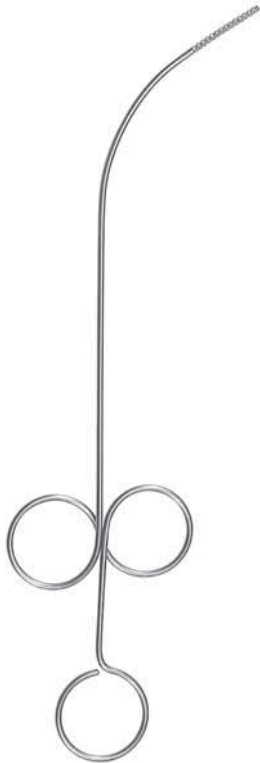

FEIN
28,0 cm, 11"
33-1264-28



UKERMANN
16,0 cm, 6 1/4"
33-1260-16



JOBSON-HORNE
18,0 cm, 7"
33-1262-18



12,0 cm, 4 3/4" **33-1271-12** Ø 0,9 mm
14,0 cm, 5 3/4" **33-1271-14** Ø 0,9 mm
16,5 cm, 6 1/4" **33-1271-16** Ø 1,1 mm
18,0 cm, 7" **33-1271-18** Ø 1,2 mm

**FARRELL
(LATHBURY)**



12,0 cm, 4 3/4" **33-1270-12** Ø 0,9 mm
14,0 cm, 5 3/4" **33-1270-14** Ø 0,9 mm
16,5 cm, 6 1/4" **33-1270-16** Ø 1,1 mm
18,0 cm, 7" **33-1270-18** Ø 1,2 mm

FARRELL

Krampfader-Besteck
Varicose Vein Probe Set
Juego para várices
Astuccio per varici



33-1150-01
 Metalletui
 Metal case
 Estuche de metal
 Scatola in metallo

135 x 100 x 25 mm

NABATOFF
33-1150-00
 komplett
 complete
 completo
 completo



Ø 3,0 mm
33-1150-03



Ø 6,0 mm
33-1150-06



Ø 9,0 mm
33-1150-09



Ø 12,0 mm
33-1150-12



33-1150-21
 Zugseil
 Cable
 Cable
 Fune

33-1150-22
 Kunststoff-Sondenspitze
 Plastic probe tip
 Extremidad de sonda de plástico
 Punta in materia plastica

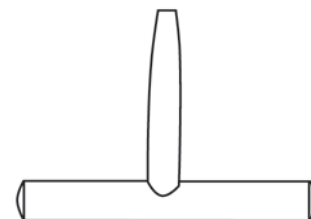

33-1150-20
 Handgriff
 Handle
 Mango
 Manico

Trokare
Trocars
Trócares
Trequarti



Ø 3,0 mm	34-1110-30
Ø 3,5 mm	34-1110-35
Ø 4,0 mm	34-1110-40
Ø 4,5 mm	34-1110-45
Ø 5,0 mm	34-1110-50
Ø 5,5 mm	34-1110-55
Ø 6,0 mm	34-1110-60

STANDARD
11,0 cm, 4³/₈"



Ø 3,0 mm	34-1112-30
Ø 3,5 mm	34-1112-35
Ø 4,0 mm	34-1112-40
Ø 4,5 mm	34-1112-45
Ø 5,0 mm	34-1112-50
Ø 5,5 mm	34-1112-55
Ø 6,0 mm	34-1112-60

STANDARD
12,0 cm, 4³/₄"



Ø 3,0 mm	34-1114-30
Ø 3,5 mm	34-1114-35
Ø 4,0 mm	34-1114-40
Ø 4,5 mm	34-1114-45
Ø 5,0 mm	34-1114-50
Ø 5,5 mm	34-1114-55
Ø 6,0 mm	34-1114-60

STANDARD
12,0 cm, 4³/₄"



Ø 7,3 mm	34-1118-07
Ø 8,7 mm	34-1118-09
Ø 12,0 mm	34-1118-12

HURWITZ

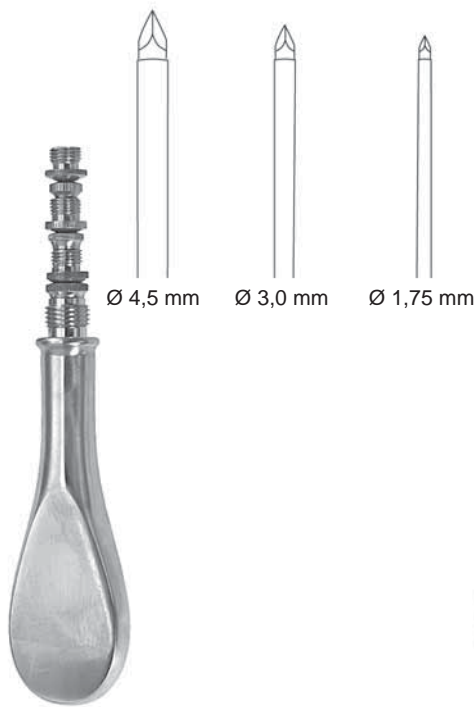

UNIVERSAL
34-1100-03

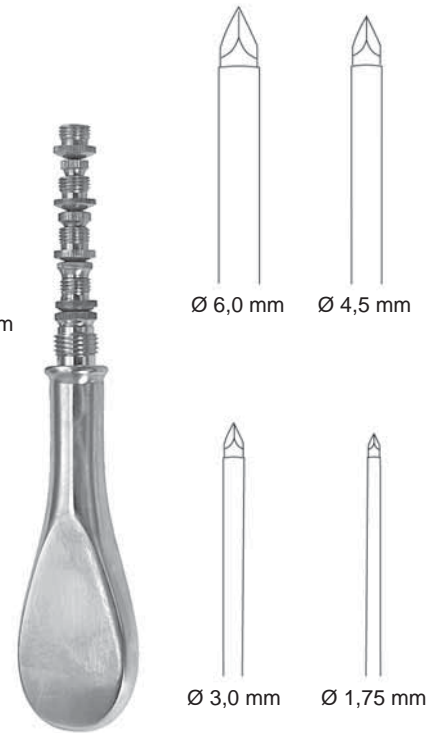

UNIVERSAL
34-1100-04

Trokare
Trocars
Trócares
Trequarti

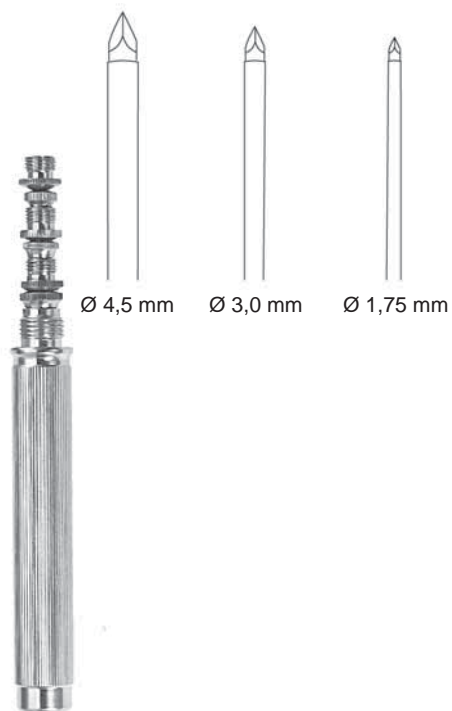

UNIVERSAL
34-1102-03

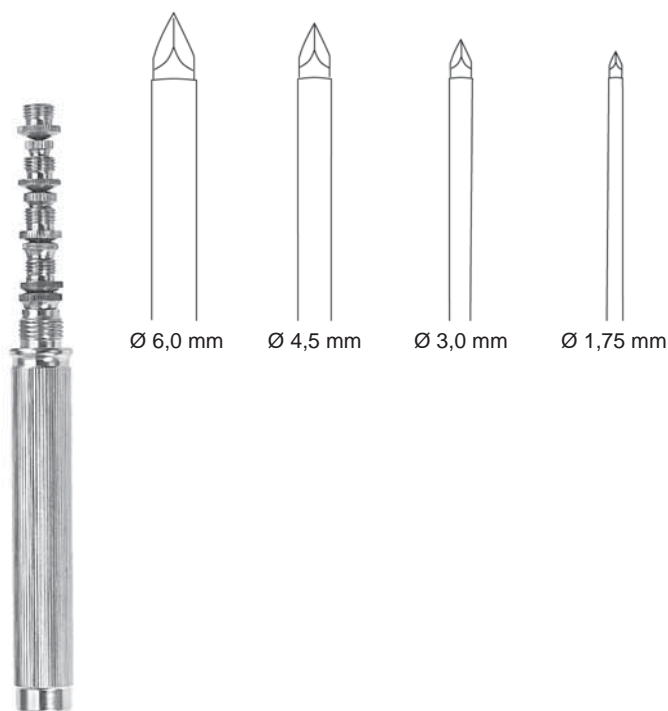

UNIVERSAL
34-1102-04

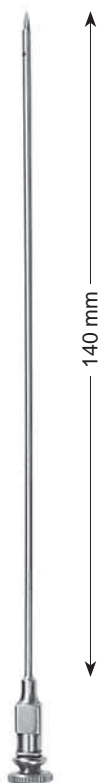

LANDAU
Ø 2,0 mm
33-1160-16



LANDAU
Ø 2,0 mm
33-1161-16



DAVIDSON
Ø 6,0 mm
33-1164-18



BUELAU
Ø 8,0 mm
33-1124-24

Trokare
Trocars
Trócares
Treuarti



Ø 2,0 mm	34-1130-20
Ø 2,5 mm	34-1130-25
Ø 3,0 mm	34-1130-30

LERMOYEZ



Ø 6,0 mm	34-1128-06
Ø 8,0 mm	34-1128-08

CAMPBELL
16,0 cm, 6¼"



Ø 7,5 mm	34-1120-01
Ø 9,0 mm	34-1120-02
Ø 10,5 mm	34-1120-03
Ø 12,0 mm	34-1120-04

NELSON
21,0 cm, 8½"



Ø 4,0 mm	34-1140-01
Ø 4,6 mm	34-1140-02
Ø 5,5 mm	34-1140-03
Ø 6,5 mm	34-1140-04

OCHSNER
14,0 cm, 5½"



Record Konus
Record cone

Ø 3,0 mm	34-1180-30
Ø 4,0 mm	34-1180-40
Ø 5,0 mm	34-1180-50

PIERCE
16,0 cm, 6¼"

Ø 2,25 mm



COAKLEY
14,0 cm, 5¼"
34-1190-14



Ø 4,0 mm

KRAUSE
16,0 cm, 6 1/4"

LICHTWITZ
Kieferhöhlentrocars
Antrum trocars
Trócares para el seno maxilar
Trequarti per puntura del seno mascellare

Ø 1,8 mm

Ø 3,0 mm	34-1184-30
Ø 4,0 mm	34-1184-40
Ø 5,0 mm	34-1184-50
Ø 5,5 mm	34-1184-55

LICHTWITZ
20,0 cm, 8"
34-1170-00

Trokare, Saugrohre
Trocars, Suction Tubes
Trócares, Tubos para aspiración
Trequarti, Tubi aspirazione



LICHTWITZ
11,0 cm, 4 1/2"
34-1172-00



DOUGLAS
Ø 3,0 mm
34-1175-00



POOLE
22,0 cm, 8 5/8"

Ø 6,0 mm	35-1020-06
Ø 10,0 mm	35-1020-10



POOLE
22,0 cm, 8 5/8"

Ø 6,0 mm	35-1021-06
Ø 8,0 mm	35-1021-08

Saugrohre
Suction Tubes
Tubos para aspiración
Tubi aspirazione

auswechselbare Spitze
interchangeable tip
punta intercambiabile
tipo intercambiabile



35-1024-00
Olive allein
Olive only
Oliva suelto
Olivo solo



COUPLAND
17,0 cm, 6³/₄"
35-1010-17



YANKAUER
27,0 cm, 10⁵/₈"
35-1000-27



DE BAKEY
27,0 cm, 10⁵/₈"
35-1008-27



ANTHONY
26,0 cm, 10¹/₄"
35-1007-26



ANDREWS-PYNCHON
24,0 cm, 9¹/₂"
35-1006-24



COOLEY
35,0 cm, 13³/₄"
Ø 8,0 mm
35-1024-02



COOLEY
30,0 cm, 11³/₄"
Ø 7,0 mm
35-1024-03



COOLEY
31,0 cm, 11³/₄"
Ø 10,0 mm
35-1024-04



COOLEY
33,0 cm, 13"
Ø 8,0 mm
35-1024-01

Ø 2,0 mm



COGSWELL
23,0 cm, 9"
35-1014-23

Saugrohre
Suction Tubes
Tubos para aspiración
Tubi aspirazione



BYRD
20,0 cm, 8"

Ø 1,5 mm	35-1012-15
Ø 2,5 mm	35-1012-25
Ø 3,5 mm	35-1012-35



HEPP/SCHIEDL
22,5 cm, 8³/₄"
35-1016-22

Ø 4,0 mm



ADSON
21,0 cm, 8¹/₄"
35-1050-21



MAGILL
17,5 cm, 6⁵/₈"

Ø 1,0 mm	35-1060-01
Ø 2,0 mm	35-1060-02
Ø 3,0 mm	35-1060-03
Ø 4,0 mm	35-1060-04



FRAZIER
19,0 cm, 7¹/₂"

Charr. 6	35-1030-06
Charr. 8	35-1030-08
Charr. 10	35-1030-10
Charr. 12	35-1030-12



FERGUSON
18,0 cm, 7"

Charr. 6	35-1033-06
Charr. 8	35-1033-08
Charr. 10	35-1033-10
Charr. 12	35-1033-12

POPPE
13,0 cm, 5"

Charr. 6	35-1034-06
Charr. 8	35-1034-08
Charr. 10	35-1034-10
Charr. 12	35-1034-12

Spezialkanülen
Special Needles
Agujas especiales
Aghi speciali



Packung zu 12 Stück
 Package of 12 pcs.
 Cajecita de 12 pzs.
 Confezione da 12 pezzi

Ø 0,90 x 38 mm	36-1000-01
Ø 0,80 x 32 mm	36-1000-02
Ø 0,70 x 32 mm	36-1000-03
Ø 0,65 x 28 mm	36-1000-04
Ø 0,60 x 25 mm	36-1000-05
Ø 0,50 x 23 mm	36-1000-06
Ø 0,45 x 20 mm	36-1000-07

LUER-LOCK

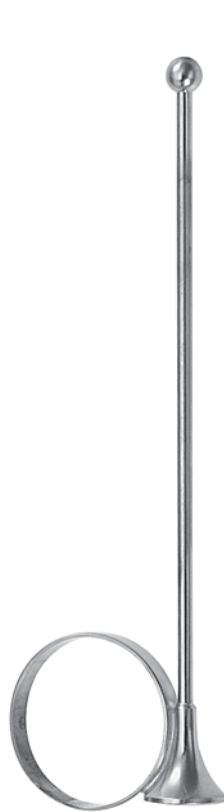

IOWA
 14,0 cm, 5 1/4"
36-1150-14

Ø 1,0 x 185 mm

36-1150-01
 Nadel
 Needle
 Aguja
 Aghi



MOCK
 6,0 cm, 2 3/8"
36-1200-06



SCHMID
 15,0 cm, 6"



Gefäßspülkanülen, biegsam
 Vascular irrigation cannulae, malleable
 Cánulas vasculares para irrigación, maleables
 Aghi vascolari per irrigazione, malleabili



Ø 1,20 x 80 mm **36-1210-12**
Ø 1,50 x 80 mm **36-1210-15**



VERESS

Ø 2,00 x 100 mm **36-1180-10**
Ø 2,00 x 120 mm **36-1180-12**
Ø 2,00 x 150 mm **36-1180-15**

Kanülen zur Sternalpunktion
Sternum puncture needles
Agujas para la punción del esternón
Aghi per puntura dello sterno



KLIMA-ROSSEGGER

Ø 1,60 x 40 mm
36-1060-16



SELDINGER-STILLE

Ø 1,60 x 70 mm **36-1650-16**
Ø 2,00 x 70 mm **36-1650-20**



BIER

Kanülen zur Lumbalpunktion
Lumbar puncture needles
Agujas para punción lumbar
Aghi per punture lombari

Ø 0,8 x 70/80/90/100/120 mm **36-1130-01**
Ø 1,0 x 70/80/90/100/120 mm **36-1130-02**
Ø 1,2 x 70/80/90/100/120 mm **36-1130-03**
Ø 1,4 x 70/80/90/100/120 mm **36-1130-04**
Ø 1,6 x 70/80/90/100/120 mm **36-1130-05**
Ø 1,8 x 70/80/90/100/120 mm **36-1130-06**
Ø 2,0 x 70/80/90/100/120 mm **36-1130-07**

Spezialkanülen
Special Needles
Agujas especiales
Aghi speciali



Kanülen zur Lumbalpunktion
 Lumbar puncture needles
 Aguja para punción lumbar
 Aghi per punture lombari

Ø 1,20 x 76 mm	36-1120-01
Ø 1,20 x 89 mm	36-1120-02
Ø 1,00 x 76 mm	36-1120-03
Ø 1,00 x 89 mm	36-1120-04
Ø 0,70 x 76 mm	36-1120-05
Ø 0,70 x 50 mm	36-1120-06
Ø 0,70 x 89 mm	36-1120-07

QUINKE

Kanülen zur Lumbalpunktion
 Lumbar puncture needles
 Aguja para punción lumbar
 Aghi per punture lombari



Ø 1,20 x 76 mm	36-1090-12
Ø 1,40 x 76 mm	36-1090-14
Ø 1,60 x 76 mm	36-1090-16

TUHOJ

Kanülen zur Leberblindpunktion
 Liver blind puncture needles
 Aguja para punción ciega del hígado
 Aghi per punture cieca del fegato



Ø 1,00 x 35 mm	36-1115-01
Ø 1,00 x 70 mm	36-1115-02
Ø 1,20 x 70 mm	36-1115-03
Ø 1,20 x 100 mm	36-1115-04
Ø 1,40 x 70 mm	36-1115-05
Ø 1,40 x 100 mm	36-1115-06
Ø 1,60 x 70 mm	36-1115-07
Ø 1,60 x 100 mm	36-1115-08

MENGHINI



Kanülen zur gezielten Leberpunktion
 Needles for controlled liver puncture
 Aguja para la punción del hígado bajo el control laparoscópico
 Aghi per la punture controllata del fegato

Ø 1,40 x 168 mm	36-1117-14
Ø 1,80 x 168 mm	36-1117-18

MENGHINI



Trokare für Kanülen
 Trocars for needles
 Trocares para agujas
 Trequarti oer aghi

Ø 1,40 x 168 mm	36-1230-14
Ø 1,80 x 168 mm	36-1230-18

Spritzen, Ersatzzylinder
 Syringes, Spare barrel
 Jeringas, Cilindro de requesto
 Siringhe, Cilindro di ricambio



1 ml **37-1051-01**
 2 ml **37-1051-02**
 5 ml **37-1051-05**
 10 ml **37-1051-10**
 20 ml **37-1051-20**
 50 ml **37-1051-50**



1 ml **37-1001-01**
 2 ml **37-1001-02**
 5 ml **37-1001-05**
 10 ml **37-1001-10**
 20 ml **37-1001-20**
 50 ml **37-1001-50**



1 ml **37-1061-01**
 2 ml **37-1061-02**



LUER

1 ml **37-1050-01**
 2 ml **37-1050-02**
 5 ml **37-1050-05**
 10 ml **37-1050-10**
 20 ml **37-1050-20**
 50 ml **37-1050-50**



LUER-LOCK

1 ml **37-1000-01**
 2 ml **37-1000-02**
 5 ml **37-1000-05**
 10 ml **37-1000-10**
 20 ml **37-1000-20**
 50 ml **37-1000-50**



LUER-LOCK

2 ml **37-1055-02**
 5 ml **37-1055-05**
 10 ml **37-1055-10**



INSULIN LUER

1 ml **37-1060-01**
 2 ml **37-1060-02**

Spritzen
Syringes
Jeringas
Siringhe



37-1066-01
1 mm



50 ml **37-1071-05**
100 ml **37-1071-10**
150 ml **37-1071-15**
200 ml **37-1071-20**



10 ml **37-1081-10**
20 ml **37-1081-20**
30 ml **37-1081-30**
50 ml **37-1081-50**



TUBERKULIN
LUER-LOCK
37-1065-01
1 mm



JANET

50 ml **37-1070-05**
100 ml **37-1070-10**
150 ml **37-1070-15**
200 ml **37-1070-20**



LUER-LOCK

10 ml **37-1080-10**
20 ml **37-1080-20**
30 ml **37-1080-30**
50 ml **37-1080-50**



TOOMEY
37-1100-50
50 mm

Verbindungsstücke, Hähne
Connecting Pieces, Stopcocks
Piezas de conexión, Llaves
Raccordi, Rubinetti

Zwischenstück, LUER-LOCK weiblich
 Connecting piece, LUER-LOCK female
 Pieza de conexión, LUER-LOCK hembra
 Raccordo, LUER-LOCK femmina



37-1911-00

Zwischenstück, LUER-LOCK männlich
 Connecting piece, LUER-LOCK male
 Pieza de conexión, LUER-LOCK masculino
 Raccordo, LUER-LOCK maschio



37-1930-02

Zwischenstück, LUER-LOCK männlich
 Connecting piece, LUER-LOCK male
 Pieza de conexión, LUER-LOCK masculino
 Raccordo, LUER-LOCK maschio

Ø 6 mm Ø 8 mm



37-1912-06

37-1912-08

Zwischenstück, LUER-LOCK weiblich
 Connecting piece, LUER-LOCK female
 Pieza de conexión, LUER-LOCK hembra
 Raccordo, LUER-LOCK femmina



37-1913-00

Zwischenstück, LUER-LOCK männlich
 Connecting piece, LUER-LOCK male
 Pieza de conexión, LUER-LOCK masculino
 Raccordo, LUER-LOCK maschio



37-1935-00

Durchflußhahn, LL männl. – LL weibl.
 Stopcock, LL male – LL female
 Llave, LL masculino – LL hembra
 Rubinetto, LL maschio – LL femmina



37-1939-00

Durchflußhahn, LL weiblich
 Stopcock, LL female
 Llave, LL hembra
 Rubinetto, LL femmina



37-1920-00

Dreiweghahn, 1 LL männl. – 2 LL weibl.
 Three-way-stopcock, 1 LL male – 2 LL female
 Llave de 3 vías, 1 LL masculino – 2 LL hembra
 Rubinetto a tre vie, 1 LL maschio – 2 LL femmina



37-1922-00

Dreiweghahn, 3 LL weiblich
 Three-way-stopcock, 3 LL female
 Llave de 3 vías, 3 LL hembra
 Rubinetto a tre vie, 3 LL femmina



37-1926-00

Galle, Leber, Niere, Blase, Urologie
Gall, Liver, Kidney, Bladder, Urology
Bilis, Hígado, Riñon, Vejiga, Urología
Bile, Fegato, Rene, Vescica, Urologia



Nierensteinzangen, Gallensteinzangen
Kidney Stone Forceps, Gall Stone Forceps
Pinzas para los cálculos renales, Pinzas para los cálculos biliares
Pinze per calcoli renali, Pinze per calcoli biliari

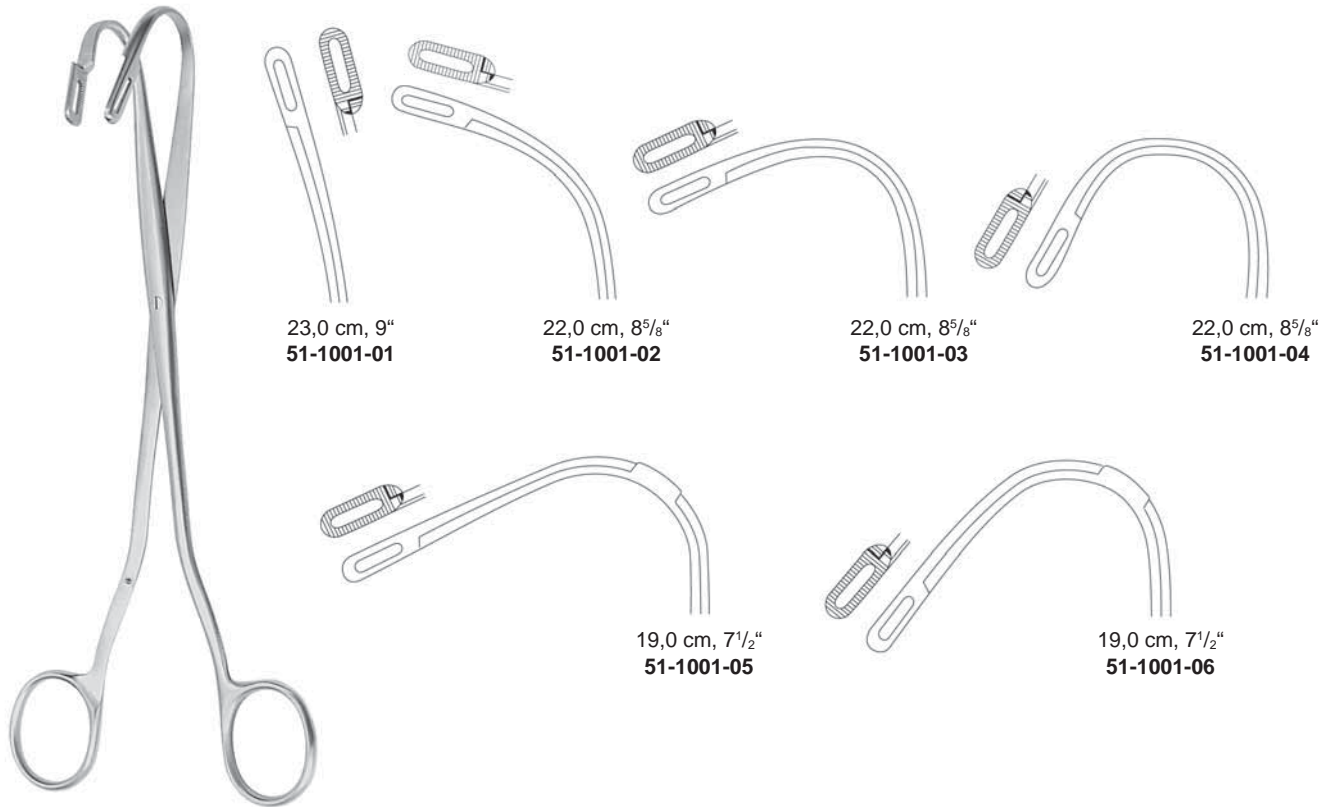

23,0 cm, 9"
51-1001-01

22,0 cm, 8⁵/₈"
51-1001-02

22,0 cm, 8⁵/₈"
51-1001-03

22,0 cm, 8⁵/₈"
51-1001-04

19,0 cm, 7¹/₂"
51-1001-05

19,0 cm, 7¹/₂"
51-1001-06

RANDALL

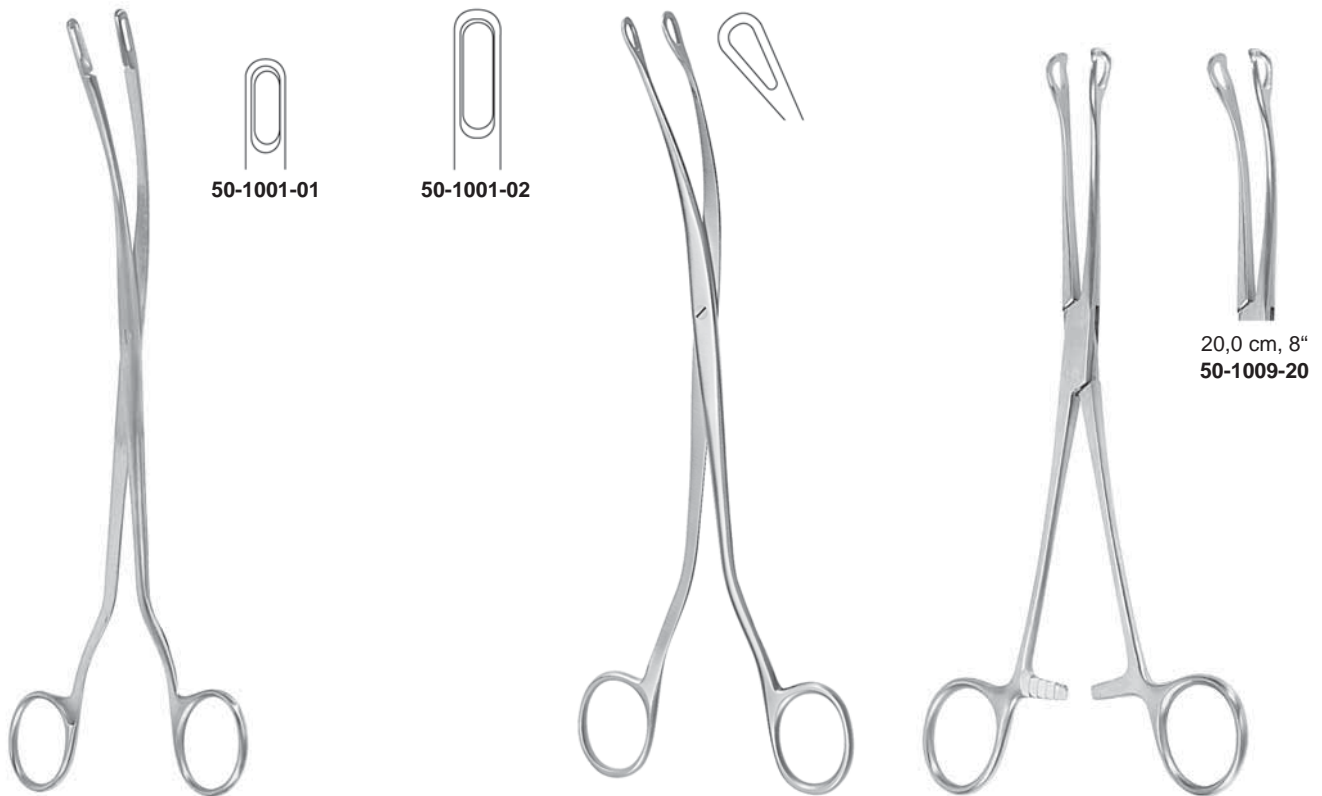

50-1001-01

50-1001-02

20,0 cm, 8"
50-1009-20

DESJARDINS
23,0 cm, 9"

MIXTER
22,0 cm, 8⁵/₈"
50-1021-22

MAYO BLAKE
20,0 cm, 8"
50-1008-20

Gallensteinzangen
 Gall Stone Forceps
 Pinzas para los cálculos biliares
 Pinze per calcoli biliari

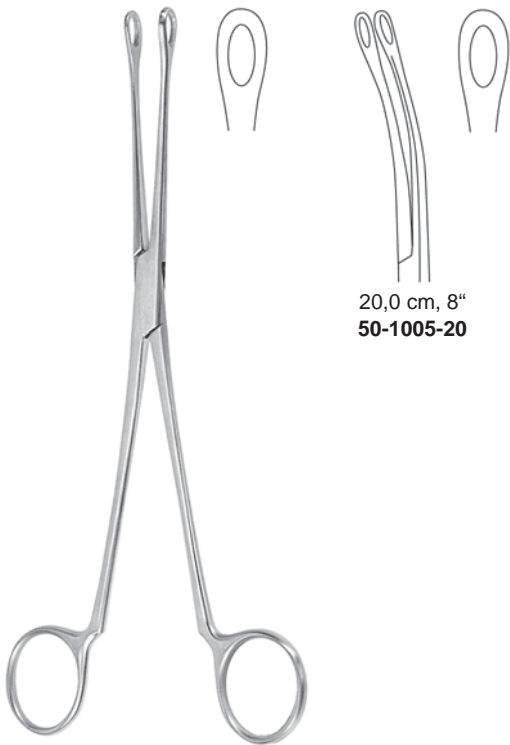

BLAKE
 20,0 cm, 8"
 50-1006-20

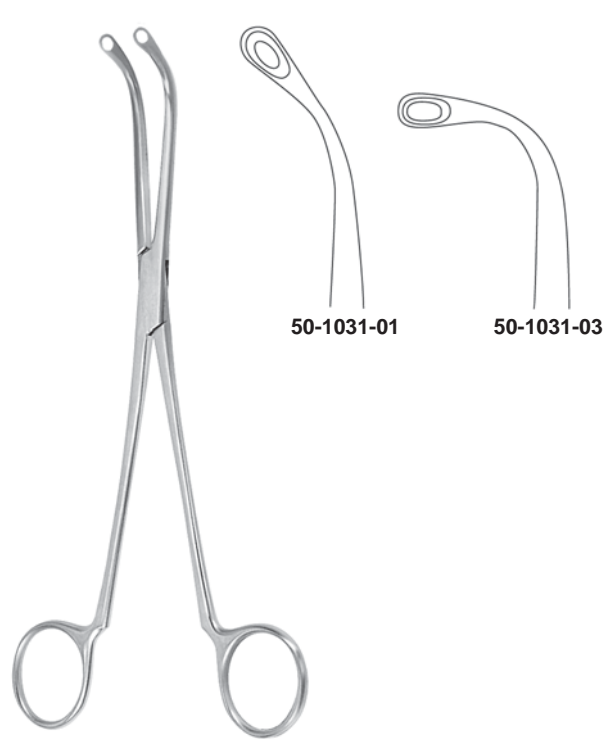

TURNER-WARWICK
 18,0 cm, 7"

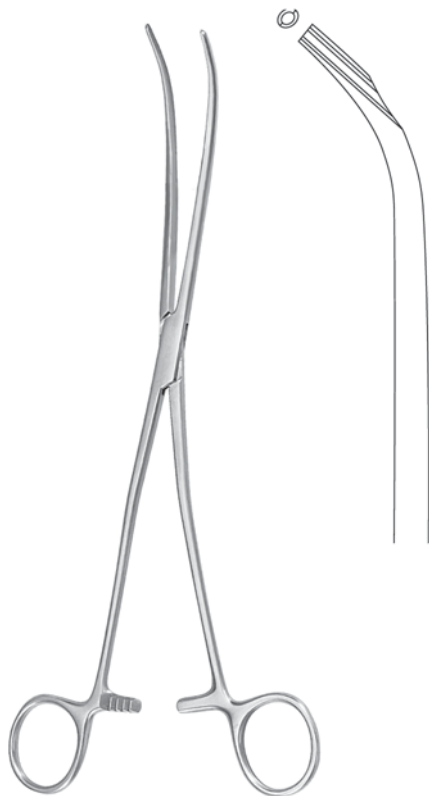

SÖKELAND
 24,0 cm, 9½"
 50-1037-24



CZERNY
 24,5 cm, 9⅝"
 50-1039-24

Gallensteinlöffel
Gall Stone Scoops
Cucharillas para los cálculos biliares
Cucchiai per calcoli biliari



LUER-KÖRTE
 24,0 cm, 9 1/2"

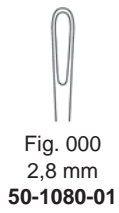

Fig. 000
 2,8 mm
50-1080-01

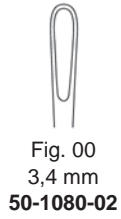

Fig. 00
 3,4 mm
50-1080-02



Fig. 2
 6,7 mm
50-1080-05



Fig. 3
 8,0 mm
50-1080-06

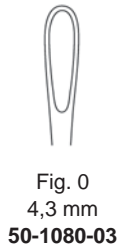

Fig. 0
 4,3 mm
50-1080-03



Fig. 1
 5,5 mm
50-1080-04



Fig. 4
 11,0 mm
50-1080-07



Fig. 5
 15,0 mm
50-1080-08



FERGUSSON
 21,5 cm, 8 1/2"
50-1070-01



MAYO
 27,0 cm, 10 5/8"
50-1072-01



MAYO
 27,0 cm, 10 5/8"

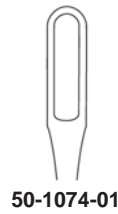

50-1074-01

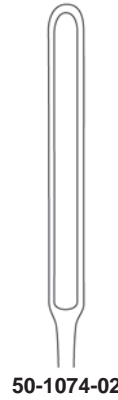

50-1074-02



MOYNIHAN
 34,0 cm, 13 3/8"
50-1076-34

Gallengangsonden, Gallengang Dilatoren
 Gall Duct Probes, Common Bile Duct Dilators
 Sonas p. el conducto biliar, Dilatadores para el conducto biliar
 Dilatatori per condotti biliari, Dilatatori per coledoco



MAYO
 32,0 cm, 12 1/2"
 50-1078-32



OCHSNER
 35,0 cm, 13 3/4"
 50-1082-35



DESJARDINS
 28,0 cm, 11"

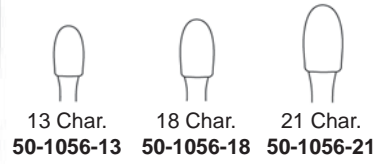

13 Char. 50-1056-13
 18 Char. 50-1056-18
 21 Char. 50-1056-21



MOORE
 30,0 cm, 12"
 50-1084-30

Gallenblasenlöffel
 Gall bladder scoope
 Cuccharilla para la vesicula biliar
 Cucchiaio per colecisti



DESJARDINS
 28,0 cm, 11"



18 Char.
 50-1058-18



21 Char.
 50-1058-21



24 Char.
 50-1058-24



27 Char.
 50-1058-26

Gallengang Dilatatoren
Common Bile Duct Dilators
Dilatadores para el conducto biliar
Dilatatori per coledoco

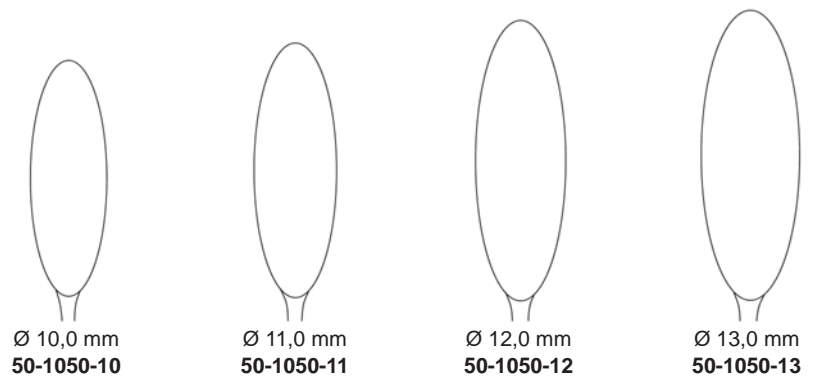
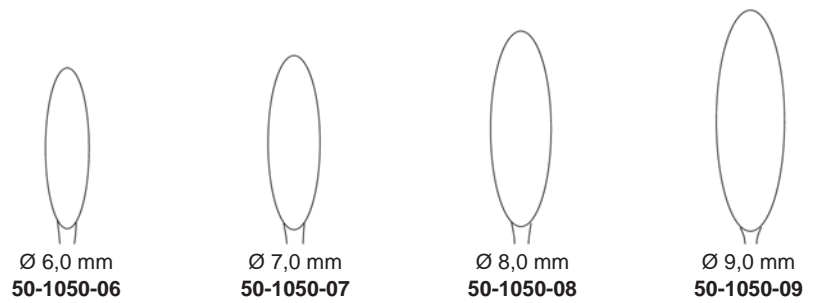
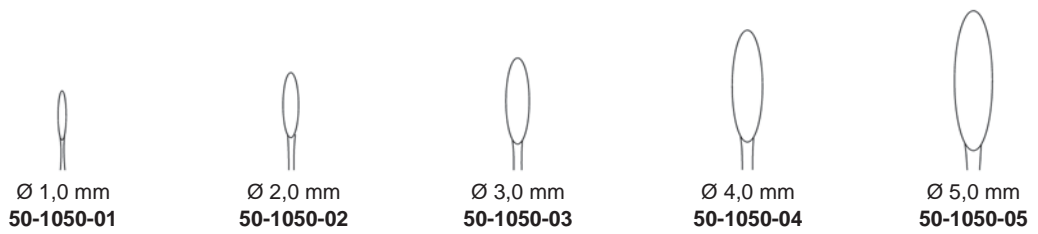

**Blasenwundspreizer
Bladder Retractors
Deparadores para la vejiga
Divaricatori vescicali**



THOMSON-WALKER
56-1182-00

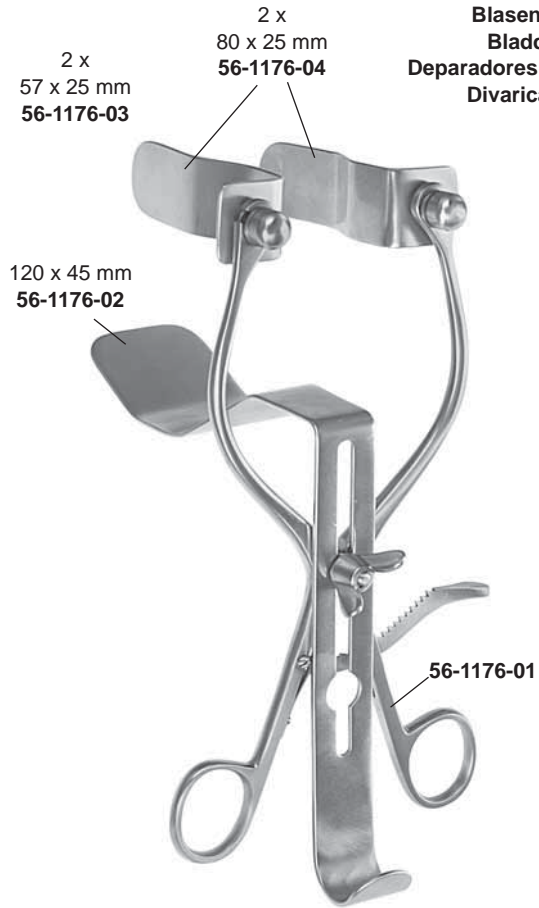

MILLIN
56-1176-00



JUDD-MASSON
56-1172-00

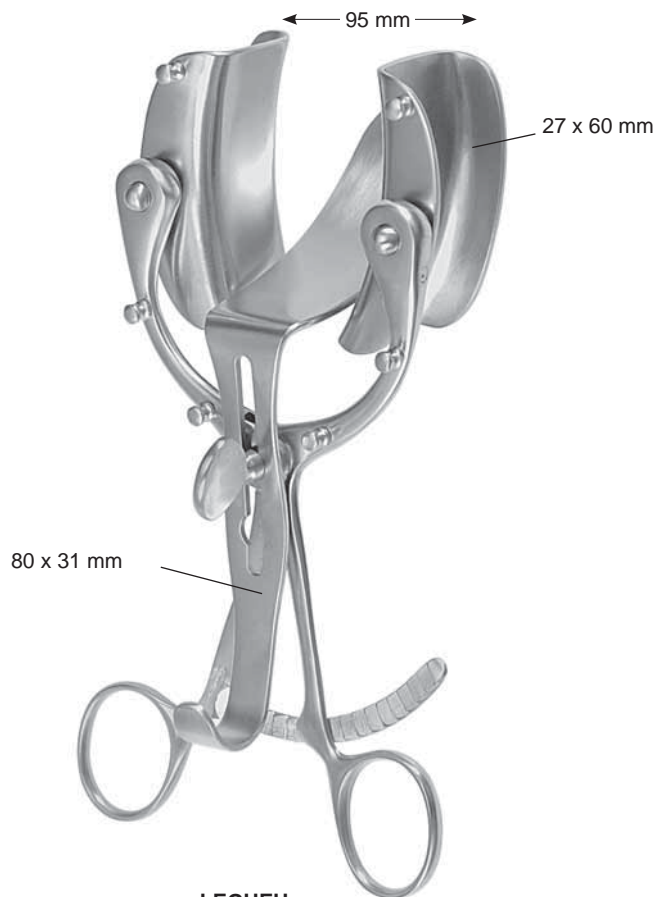

LEGUEU
56-1160-00

Instrumente für Prostatektomie
 Prostatectomy Instruments
 Instrumentos para la prostatectomía
 Strumenti per operazioni della prostata



MILLIN
 23,0 cm, 9"
 56-1073-23



ATRAUMA
MILLIN
 24,0 cm, 9½"
 56-1071-24

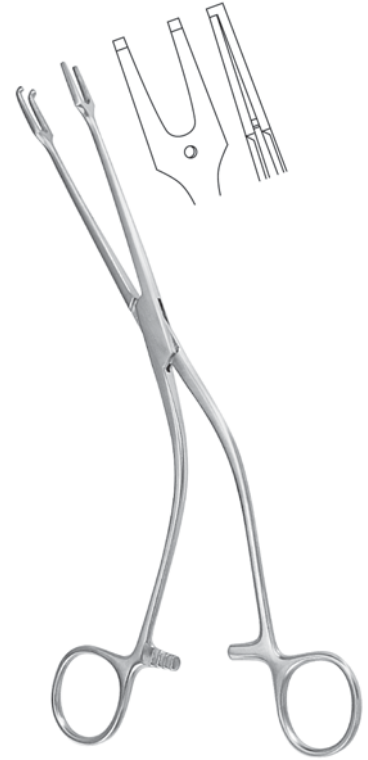

MILLIN
 24,0 cm, 9½"
 56-1077-24



MILLIN
 23,0 cm, 9"
 56-1075-23



MILLIN
 28,5 cm, 11¼"
 56-1150-24

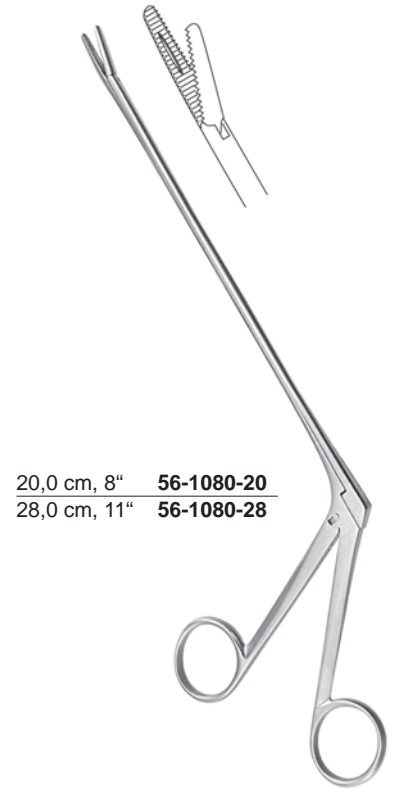

20,0 cm, 8" **56-1080-20**
 28,0 cm, 11" **56-1080-28**

MATHIEU

Prostatahaken, Blasenspatel
Prostatic Retractors, Bladder Retractor
Separadores para la prostata, Separadores vesicales
Retrattori prostatici, Divaricatori vescicali



YOUNG
21,0 cm, 8¹/₄"
56-1230-21



YOUNG
22,0 cm, 8⁵/₈"
56-1236-22



YOUNG
21,0 cm, 8¹/₄"
56-1238-21

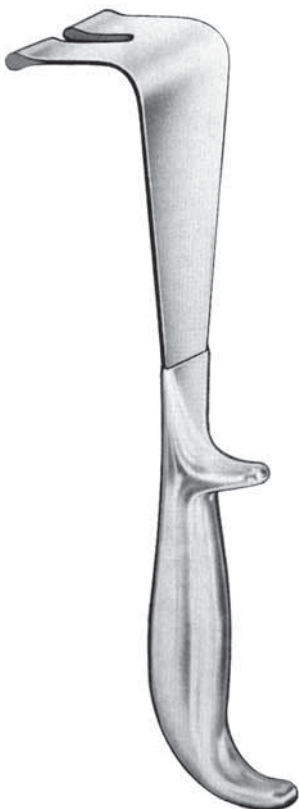

YOUNG
22,0 cm, 8⁵/₈"
56-1240-22



LEGUEU
26,0 cm, 10¹/₄"
56-1250-26



KOCHER
23,5 cm, 9¹/₄"
56-1257-23

Katheter, Penisklemmen
Catheters, Penis Clamp
Sondas, Compresor urétral
Cateteri, Serrapene



für Männer
 for men
 para hombres
 per uomini

Char. 8	56-1650-08
Char. 10	56-1650-10
Char. 12	56-1650-12
Char. 14	56-1650-14
Char. 16	56-1650-16
Char. 18	56-1650-18
Char. 20	56-1650-20
Char. 22	56-1650-22
Char. 24	56-1650-24

29,0 cm, 11¹/₂"



für Frauen
 for women
 para mujeres
 per donne

Char. 6	56-1660-06
Char. 7	56-1660-07
Char. 8	56-1660-08
Char. 9	56-1660-09
Char. 10	56-1660-10
Char. 11	56-1660-11
Char. 12	56-1660-12
Char. 13	56-1660-13
Char. 14	56-1660-14
Char. 15	56-1660-15
Char. 16	56-1660-16
Char. 18	56-1660-18
Char. 20	56-1660-20
Char. 24	56-1660-24

16,0 cm, 6¹/₄"



STRAUSS
 11,0 cm, 4¹/₃"
 56-1349-11



STOCKMANN
 8,0 cm, 3¹/₄"
 56-1345-08

Ø 8,0 mm	56-1350-08
Ø 11,0 mm	56-1350-11
Ø 13,0 mm	56-1350-13
Ø 16,0 mm	56-1350-16
Ø 21,0 mm	56-1350-21
Ø 26,0 mm	56-1350-26
Ø 32,0 mm	56-1350-32



COMCO

Magen, Darm, Mastdarm
Stomach, Intestines, Rectum
Estómago, Intestino, Recto
Stomaco, Intestino, Retto



Darm- und Gewebefaßzangen
Intestinal and Tissue Grasping Forceps
Pinzas intestinales y para tejidos
Pinze da presa per intestino e tessuti

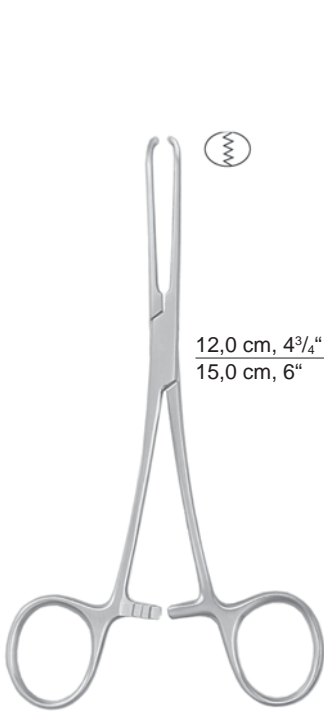

12,0 cm, 4³/₄" **52-1000-12**
 15,0 cm, 6" **52-1000-15**

ALLIS-BABY

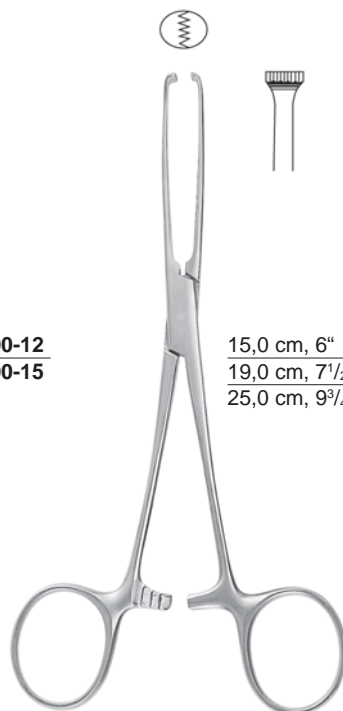

15,0 cm, 6" **52-1004-15**
 19,0 cm, 7¹/₂" **52-1004-19**
 25,0 cm, 9³/₄" **52-1004-25**

ALLIS

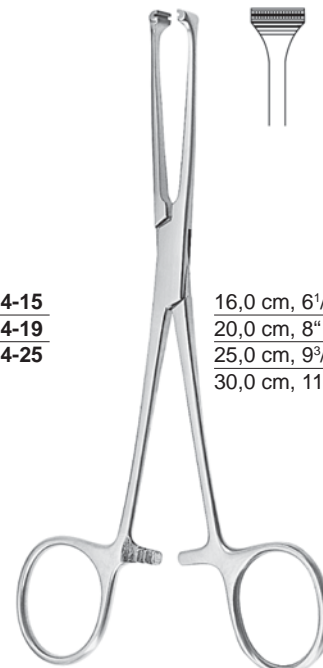

16,0 cm, 6¹/₄" **54-1124-16**
 20,0 cm, 8" **54-1124-20**
 25,0 cm, 9³/₄" **54-1124-25**
 30,0 cm, 11³/₄" **54-1124-30**

ALLIS-ATRAUMA



15,5 cm, 6" **52-1020-15**
 20,0 cm, 8" **52-1020-20**
 23,0 cm, 9" **52-1020-23**

ALLEN

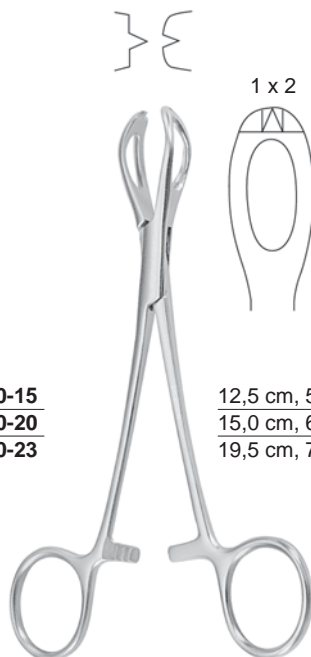

12,5 cm, 5" **52-1030-12**
 15,0 cm, 6" **52-1030-15**
 19,5 cm, 7³/₄" **52-1030-19**

LANE

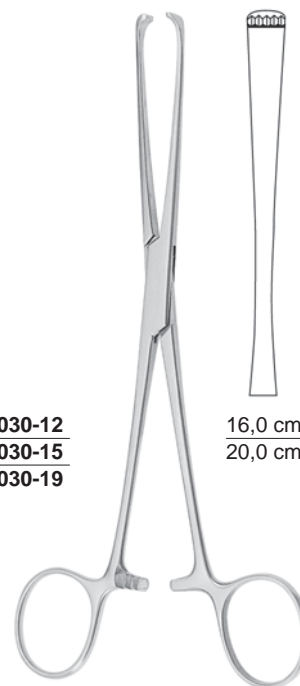

16,0 cm, 6¹/₄" **52-1178-16**
 20,0 cm, 8" **52-1178-20**

LOCKWOOD-ALLIS

Darm- und Gewebefäßzangen
 Intestinal and Tissue Grasping Forceps
 Pinzas intestinales y para tejidos
 Pinze da presa per intestino e tessuti



15,0 cm, 6" **52-1040-15**
 19,0 cm, 7½" **52-1040-19**

JUDD-ALLIS



LITTLEWOOD
 18,5 cm, 7¼"
52-1060-16



ALLIS-ADAIR
 15,5 cm, 6"
52-1010-15



BOYS-ALLIS
 15,5 cm, 6"
52-1012-15



THOMS-ALLIS
 20,0 cm, 8"
52-1050-20



ALLIS
 20,0 cm, 8"
52-1014-20

Darm- und Gewebefaßzangen
Intestinal and Tissue Grasping Forceps
Pinzas intestinales y para tejidos
Pinze da presa per intestino e tessuti



LOCKWOOD
 20,0 cm, 8"
 52-1169-20

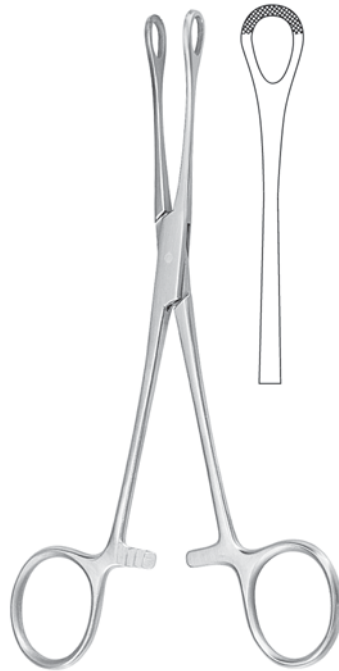

WILLIAMS
 16,0 cm, 6 1/4"
 52-1070-16



16,0 cm, 6 1/4" **52-1006-16**
 18,0 cm, 7" **52-1006-18**
 20,0 cm, 8" **52-1006-20**
 24,0 cm, 9 1/2" **52-1006-24**

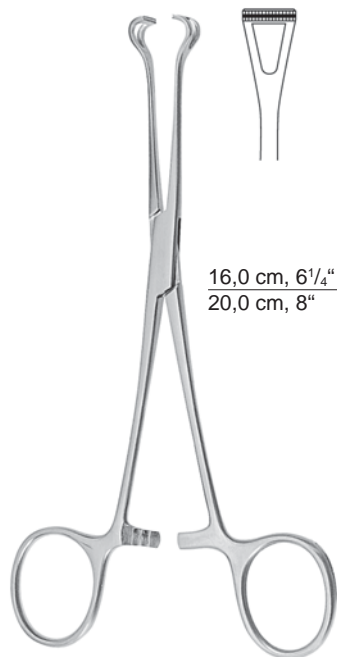

16,0 cm, 6 1/4" **54-1006-16**
 20,0 cm, 8" **54-1006-20**

BABCOCK-ATRAUMA



16,0 cm, 6 1/4" **53-1006-16**
 20,0 cm, 8" **53-1006-20**

BABCOCK-TC



DUVAL-TC
 20,0 cm, 8"
 53-1170-20

Darmklemmen
 Intestinal Clamp Forceps
 Pinzas-clamps intestinales
 Pinze intestinali

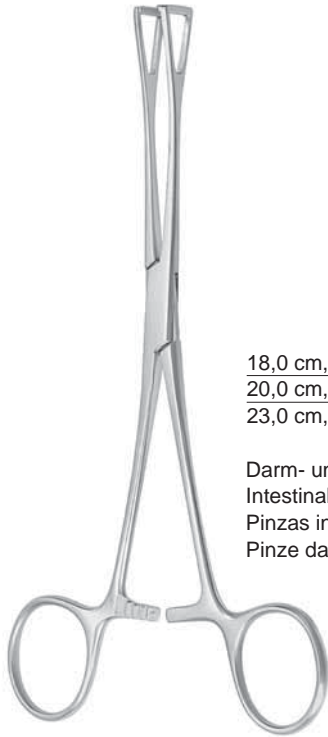

18,0 cm, 7" **52-1170-18**
 20,0 cm, 8" **52-1170-20** **52-1172-20**
 23,0 cm, 9" **52-1172-23**

Darm- und Gewebefaßzangen
 Intestinal and Tissue Grasping Forceps
 Pinzas intestinales y para tejidos
 Pinze da presa per intestino e tessuti

DUVAL



52-1200-18

52-1201-18

BABY-DOYEN
 18,0 cm, 7"



21,0 cm, 8 1/4" **52-1210-21**
 23,0 cm, 9" **52-1210-23**

21,0 cm, 8 1/4" **52-1211-21**
 23,0 cm, 9" **52-1211-23**

DOYEN

Darmklemmen
Intestinal Clamp Forceps
Pinzas-clamps intestinales
Pinze intestinali



DOYEN



21,0 cm, 8¹/₄" **54-1210-21**
 23,0 cm, 9" **54-1210-23**

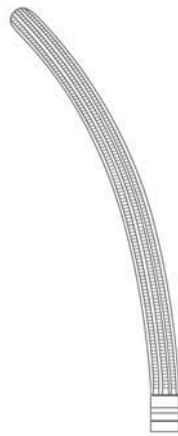

21,0 cm, 8¹/₄" **54-1211-21**
 23,0 cm, 9" **54-1211-23**

mit atraumatischer Zahnung
 with atraumatic serration
 con bacos atraumáticos
 con morsi atraumatici



KOCHER



22,0 cm, 8⁵/₈" **52-1234-22**
 25,0 cm, 9³/₄" **52-1234-25**
 28,0 cm, 11" **52-1234-28**



22,0 cm, 8⁵/₈" **52-1235-22**
 25,0 cm, 9³/₄" **52-1235-25**
 28,0 cm, 11" **52-1235-28**

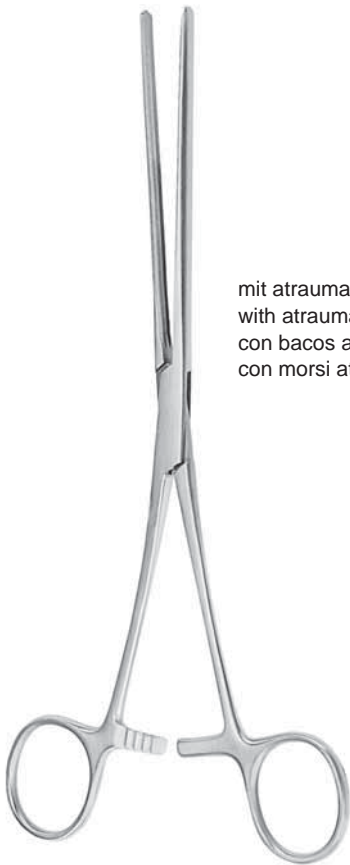

mit atraumatischer Zahnung
 with atraumatic serration
 con bacos atraumáticos
 con morsi atraumatici



22,0 cm, 8⁵/₈" **54-1234-22**
 25,0 cm, 9³/₄" **54-1234-25**
 28,0 cm, 11" **54-1234-28**



22,0 cm, 8⁵/₈" **54-1235-22**
 25,0 cm, 9³/₄" **54-1235-25**
 28,0 cm, 11" **54-1235-28**

KOCHER



21,0 cm, 8¹/₄" **52-1230-21**
 23,0 cm, 9" **52-1230-23**
 25,0 cm, 9³/₄" **52-1230-25**



21,0 cm, 8¹/₄" **52-1231-21**
 23,0 cm, 9" **52-1231-23**
 25,0 cm, 9³/₄" **52-1231-25**

MAYO-ROBSON

Darmklemmen
Intestinal Clamp Forceps
Pinzas-clamps intestinales
Pinze intestinali



21,0 cm, 8¹/₄" **54-1230-21**
 23,0 cm, 9" **54-1230-23**
 25,0 cm, 9³/₄" **54-1230-25**

mit atraumatischer Zahnung
 with atraumatic serration
 con bacos atraumáticos
 con morsi atraumatici

MAYO-ROBSON



21,0 cm, 8¹/₄" **54-1231-21**
 23,0 cm, 9" **54-1231-23**
 25,0 cm, 9³/₄" **54-1231-25**

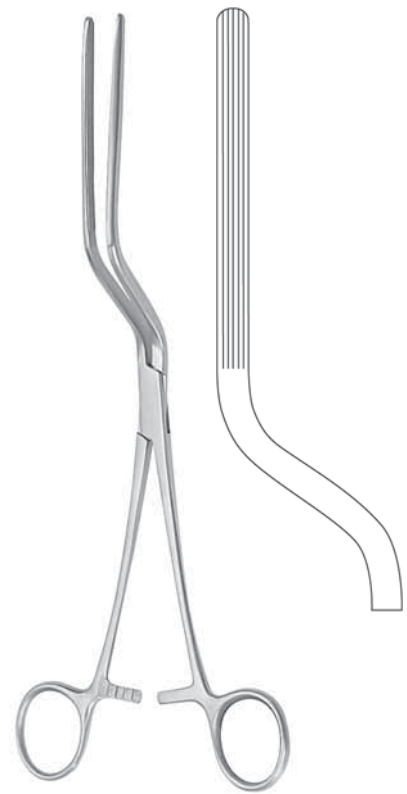

BRUNNER
 24,0 cm, 9¹/₂"
52-1240-24

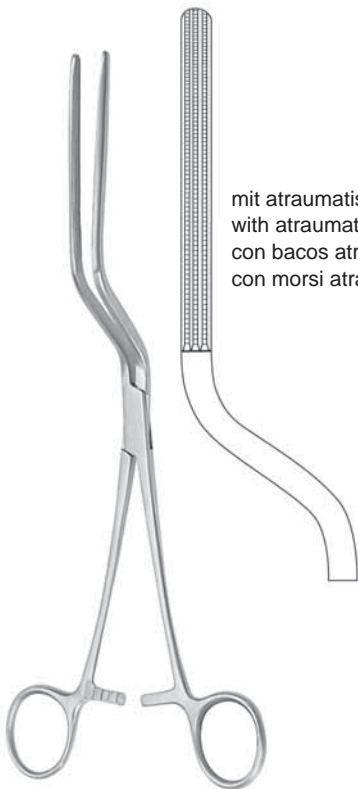

mit atraumatischer Zahnung
 with atraumatic serration
 con bacos atraumáticos
 con morsi atraumatici

BRUNNER
 24,0 cm, 9¹/₂"
54-1240-24

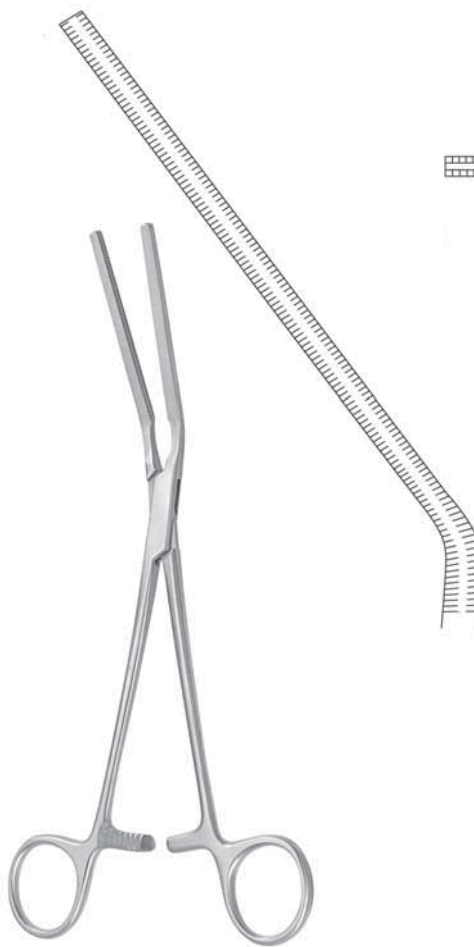

GLASSMAN
 23,0 cm, 9"
52-1259-23



GLASSMAN
 23,5 cm, 9¹/₄"
52-1253-23

Darm- und Magenquetschklemmen
 Intestinal and Stomach Clamps
 Pinzas-clamps intestinales y estomacales
 Pinze/Clamp per intestino e stomaco



Maullänge
 length of jaws
 longitud de la boca
 bocche lungh.

5,0 cm, 2"	52-1320-05
7,0 cm, 2 1/2"	52-1320-07
10,0 cm, 4"	52-1320-10

DE MARTEL-WOLFSON



DE MARTEL-WOLFSON
 8,5 cm, 3 1/2"
52-1340-08



DE MARTEL-WOLFSON
 26,0 cm, 10 1/4"
52-1325-26



BABY-PAYR
 15,0 cm, 6"



52-1310-15
 mit Stift
 with pin
 con espiga
 con perno



52-1311-15
 ohne Stift
 without pin
 sin espiga
 senza perno



PAYR



21,0 cm, 8 1/4"
 29,0 cm, 11 1/2"

52-1310-21
 mit Stift
 with pin
 con espiga
 con perno



52-1311-21
 ohne Stift
 without pin
 sin espiga
 senza perno

Darm- und Magenklappen
 Intestinal and Stomach Clamp Forceps
 Pinzas-clamps intestinales y estomacales
 Pinze per intestino e stomaco



52-1360-30

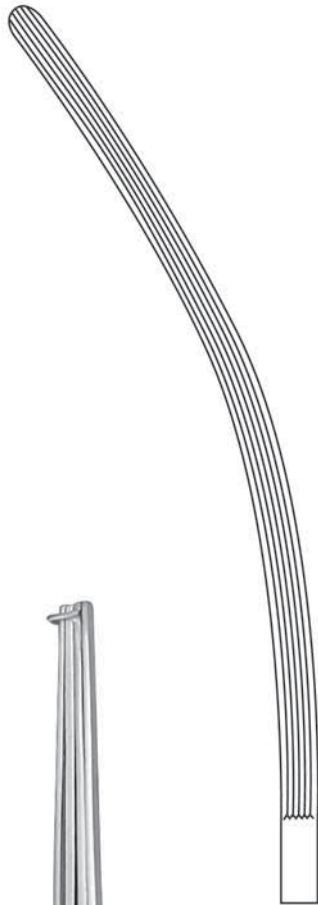

52-1361-30

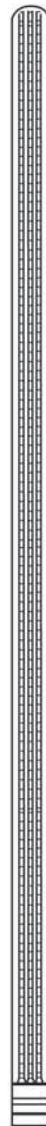

52-1364-33

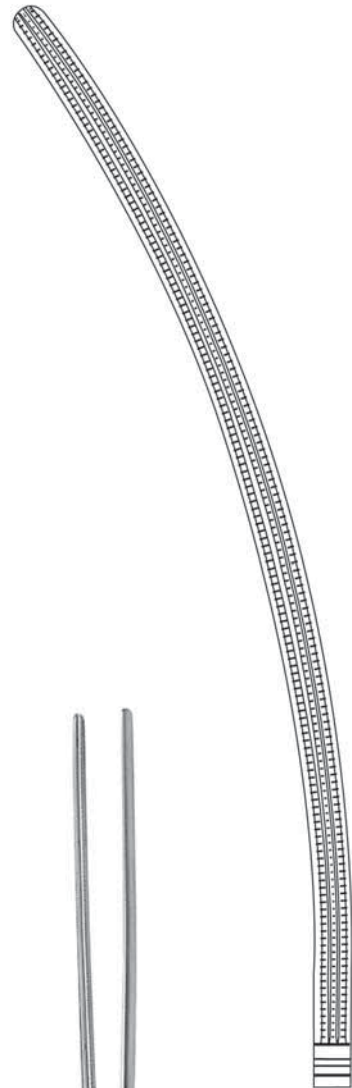

52-1365-33

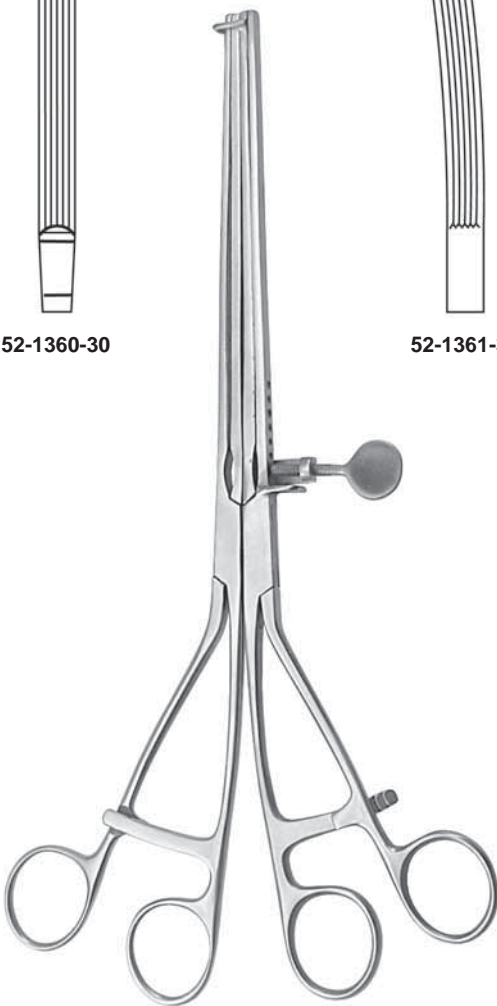

LANE
 30,0 cm, 11³/₄"

mit atraumatischer Zahnung
 with atraumatic serration
 con bacos atraumáticas
 con morsi atraumatici



SCUDDER
 33,0 cm, 13"

Rektum-Anastomosenklemmen
Sigmoid Anastomosis Forceps
Pinzas para anastomosis de recto
Pinze per anastomosi de retto



MIKULICZ
19,0 cm, 7½"
55-1010-19

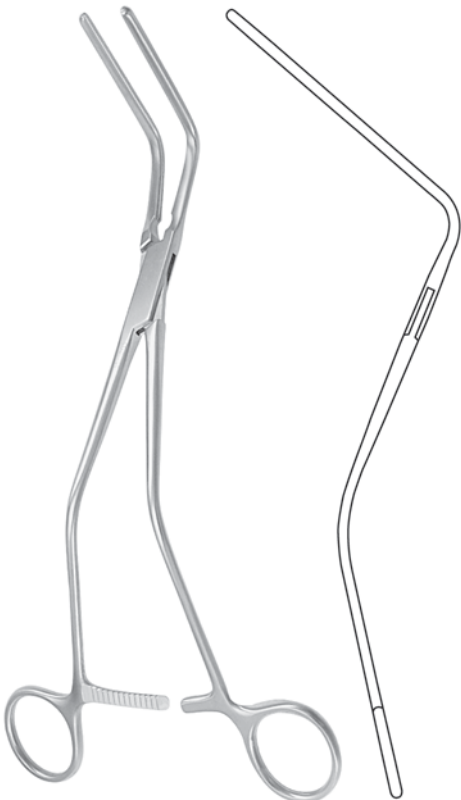

HAYES

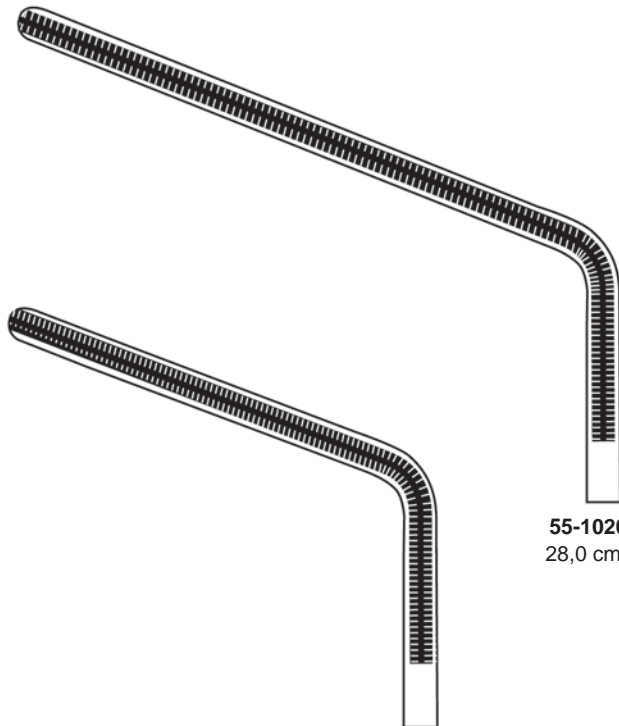

55-1020-28
28,0 cm, 11"

55-1020-26
26,0 cm, 10"

Mastdarm-Rektum-Spekula
Rectal Specula
Espéculos para el recto
Speculi rectali

17 x 89 mm



SIMS
 15,0 cm, 6"
 55-1108-15

17 x 89 mm



SIMS
 15,0 cm, 6"
 55-1110-15

25 x 89 mm



MATHIEU
 21,0 cm, 8¼"
 55-1150-21

75 x 23 mm



SMITH-BUIE
 15,0 cm, 6"
 55-1160-15

Analspreizer, Sphinkterskope, Anuskope
Rectal Retractor, Sphincteroscopes, Anoscope
Separadores para el recto, Esfinteroscopios, Anoscopios
Dilatatori per l'ano ed il retti, Sfinteroscopi, Anoscopi

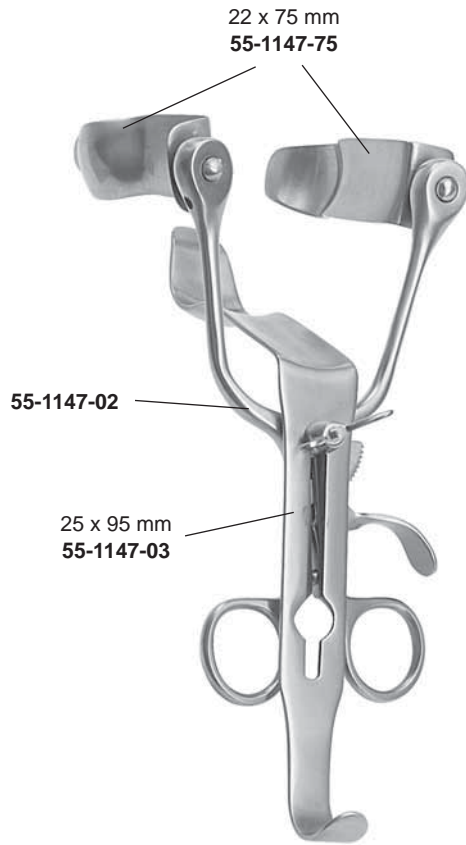

ALAN PARKS
 13,5 cm, 5³/₈"
 55-1147-00



Kaltlichtkammer für Proktoskope
 Cold-light clip for proctoscopes
 Clip para luz fría con proctoscopios
 Clip per luce fredda con protoscopi

55-1200-00

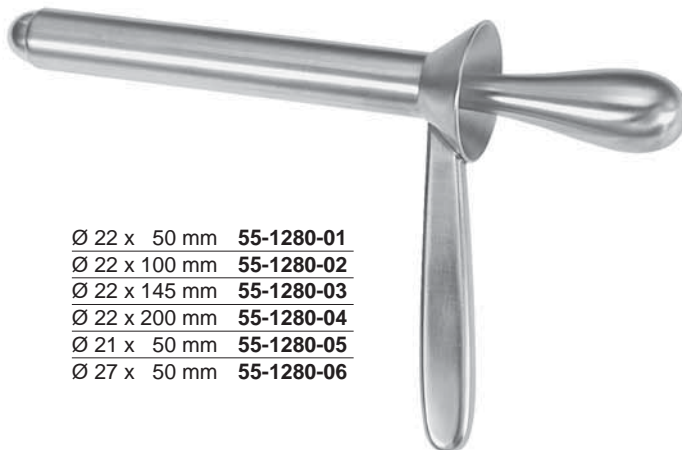

- Ø 22 x 50 mm **55-1280-01**
- Ø 22 x 100 mm **55-1280-02**
- Ø 22 x 145 mm **55-1280-03**
- Ø 22 x 200 mm **55-1280-04**
- Ø 21 x 50 mm **55-1280-05**
- Ø 27 x 50 mm **55-1280-06**

HAYES

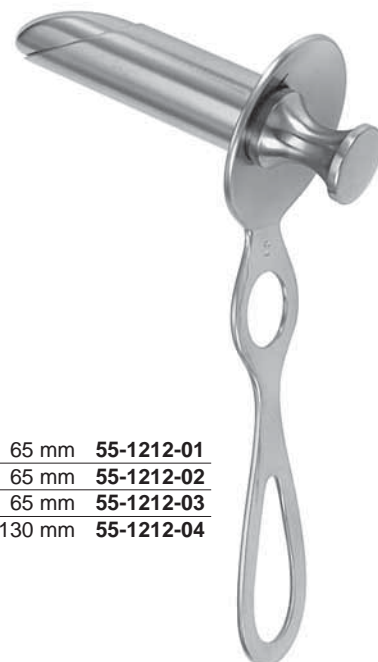

- Ø 16 x 65 mm **55-1212-01**
- Ø 19 x 65 mm **55-1212-02**
- Ø 22 x 65 mm **55-1212-03**
- Ø 22 x 130 mm **55-1212-04**

HIRSCHMANN

Anuskope, Proktoskope
 Anoscope, Proctoscopes
 Anoscopios, Proctoscopios
 Anoscopi, Protoscopi



Ø 22 x 65 mm **55-1250-22**
 Ø 30 x 65 mm **55-1250-30**

CHELSEA EATON



ohne Kaltlichtträger
 without cold light carrier
 sin portador para luz fría
 senza luce fredda

IVES FANSLER
 Ø 22 mm
55-1268-01

mit Kaltlichtträger
 with cold light carrier
 con portador para luz fría
 con luce fredda

IVES FANSLER
 Ø 22 mm
55-1268-02



Ø 17 x 65 mm **55-1220-01**
 Ø 17 x 80 mm **55-1220-02**
 Ø 20 x 65 mm **55-1220-03**
 Ø 20 x 80 mm **55-1220-04**
 Ø 24 x 65 mm **55-1220-05**
 Ø 24 x 80 mm **55-1220-06**

55-1000-02

MORGAN



Ø 25 x 65 mm **55-1124-25**
 Ø 29 x 65 mm **55-1124-29**
 Ø 38 x 70 mm **55-1124-38**

FANSLER

Mastdarm-Biopsiezangen
Rectal Biopsy Forceps
Pinzas sacabocado para biopsia rectal
Pinze taglianti per biopsia rettale

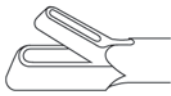

28,0 cm, 11"	55-1300-28
35,0 cm, 13 ³ / ₄ "	55-1300-35
42,0 cm, 16 ¹ / ₂ "	55-1300-42



28,0 cm, 11"	55-1311-28
35,0 cm, 13 ³ / ₄ "	55-1311-35
42,0 cm, 16 ¹ / ₂ "	55-1311-42

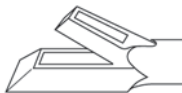

28,0 cm, 11"	55-1301-28
35,0 cm, 13 ³ / ₄ "	55-1301-35
42,0 cm, 16 ¹ / ₂ "	55-1301-42

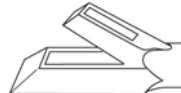

28,0 cm, 11"	55-1312-28
35,0 cm, 13 ³ / ₄ "	55-1312-35
42,0 cm, 16 ¹ / ₂ "	55-1312-42

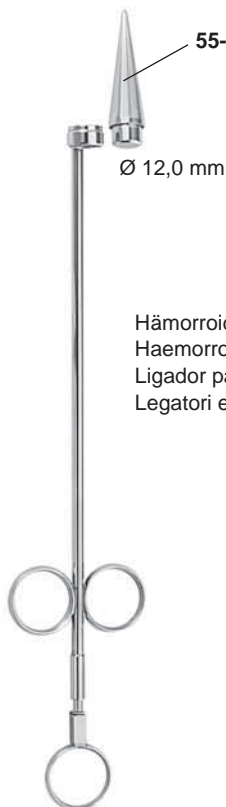

55-1405-12

Ø 12,0 mm

Hämorrhoiden-Ligator mit Ladekonus
 Haemorrhoidal ligator with loading attachment
 Ligador para hemorroides con cono de carga
 Legatori emorroidali con carica a cono

RUDD
55-1400-00

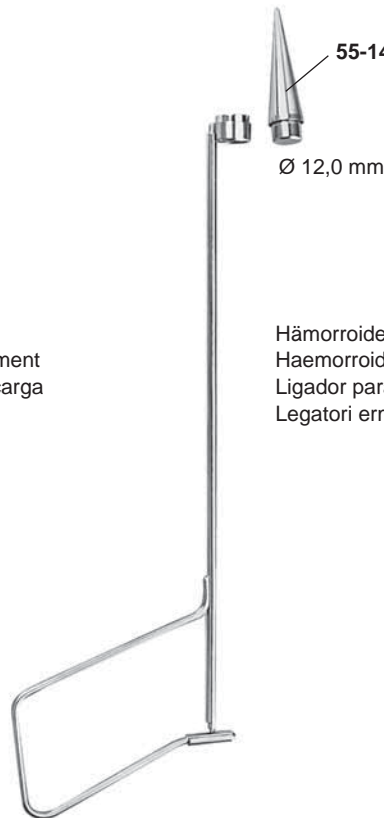

55-1405-12

Ø 12,0 mm

Hämorrhoiden-Ligator mit Ladekonus
 Haemorrhoidal ligator with loading attachment
 Ligador para hemorroides con cono de carga
 Legatori emorroidali con carica a cono

MC GIVNEY
55-1410-00

Hämorrhoiden-Faßzangen, Fistelsonden
Haemorrhoidal Forceps, Fistula probes
Pinza-clamps para hemorroides, Sondas para fistula
Pinze per emorroidi, Sonde per fistola



MC GIVNEY
19,0 cm, 7½"
55-1471-19



MC GIVNEY
19,0 cm, 7½"
55-1473-19



PRATT
21,0 cm, 8¼"



33-1135-01



33-1135-02



33-1135-03

Gynäkologie, Geburtshilfe
Gynecology, Obstetrics
Ginecología, Obstetricia
Ginecologia, Ostetricia



Scheidenspekula
 Vaginal Specula
 Espéculos vaginales
 Speculi vaginali

für Jungfrauen
 for virgins
 para vírgenes
 per vergini



COLLIN
 65 x 10 mm
 57-1132-00

für Kinder
 for children
 para niños
 per bambini



COLLIN
 65 x 10 mm
 57-1134-00



COLLIN
 85 x 30 mm 57-1130-01
 100 x 35 mm 57-1130-02
 110 x 40 mm 57-1130-03



80 x 24 mm 57-1142-01
 80 x 32 mm 57-1142-02
 98 x 16 mm 57-1142-03
 105 x 25 mm 57-1142-04
 107 x 29 mm 57-1142-05
 115 x 35 mm 57-1142-06

Scheidenspekula
Vaginal Specula
Espéculos vaginales
Speculi vaginali

zentrale Stellschraube
central fixation screw
tornillo de sujeto central
vite di regolazione centrale



CUSCO

75 x 32 mm	57-1144-01
85 x 36 mm	57-1144-02
95 x 37 mm	57-1144-03

seitliche Stellschraube
lateral fixation screw
tornillo de sujeto lateral
vite di regolazione laterale

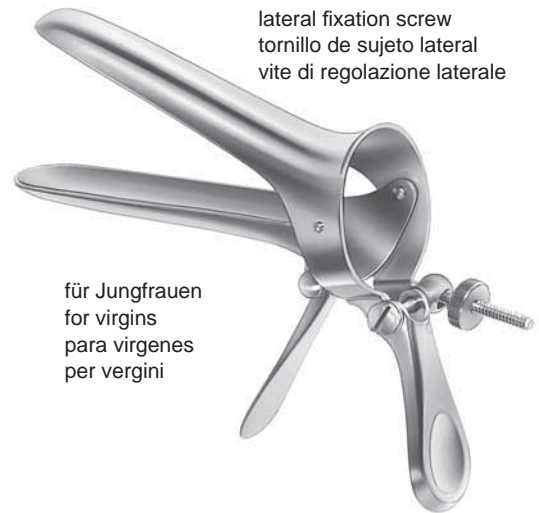

für Jungfrauen
for virgins
para virgenes
per vergini

CUSCO

75 x 17 mm	57-1140-00
------------	-------------------

seitliche Stellschraube
lateral fixation screw
tornillo de sujeto lateral
vite di regolazione laterale



CUSCO

75 x 32 mm	57-1140-01
85 x 35 mm	57-1140-02
100 x 35 mm	57-1140-03

Schweizer Modell
Swiss pattern
Modelo suizo
Modello svizzero



CUSCO

90 x 23-25 mm	57-1146-01
100 x 25-27 mm	57-1146-02
110 x 27-30 mm	57-1146-03

Scheidenspekula
 Vaginal Specula
 Espéculos vaginales
 Speculi vaginali



GRAVE

75 x 20 mm	57-1100-01
95 x 35 mm	57-1100-02
115 x 35 mm	57-1100-03



PEDERSON

75 x 13 mm	57-1120-01
100 x 22 mm	57-1120-02
120 x 25 mm	57-1120-03



SEMM

90 x 14-18 mm	57-1150-01
100 x 17-20 mm	57-1150-02
100 x 25-30 mm	57-1150-03



WEISSBARTH

21,0 cm, 8 1/4"	57-1160-00
-----------------	------------



mit abnehmbarem Gewicht
 with detachable weight
 con peso desmontable
 con peso smontabile

1,14 kg

AUVARD
 75 x 38 mm
 57-1170-00



mit festem Gewicht
 with fixed weight
 con peso fijo
 con peso fisso

1,14 kg

AUVARD
 75 x 38 mm
 57-1172-00

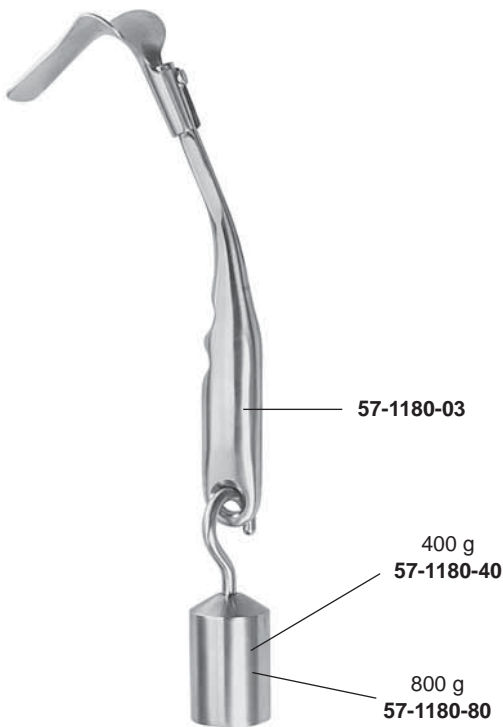

SCHERBACK
 57-1180-00

koplett, complete, completo, completo

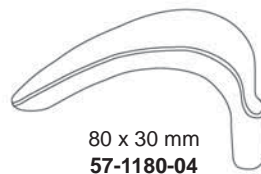

80 x 30 mm
 57-1180-04

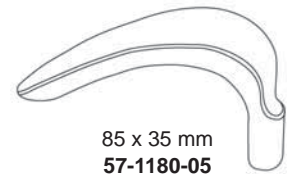

85 x 35 mm
 57-1180-05

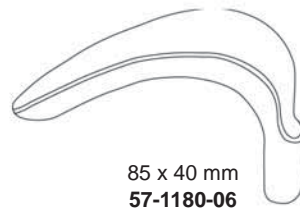

85 x 40 mm
 57-1180-06



55 x 40-60 mm
 57-1180-07

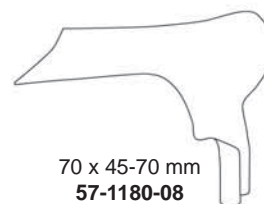

70 x 45-70 mm
 57-1180-08

Scheidenspekula
 Vaginal Specula
 Espéculos vaginales
 Speculi vaginali



Satz
 Set
 Juego
 Set

KRISTELLER

Fig. 1 **57-1220-01**
 Fig. 2 **57-1220-02**
 Fig. 3 **57-1220-03**



Spekula allein, flach
 Specula only, flat hollow
 Espéculos suelto, con huecos planos
 Solo speculi, piatta

KRISTELLER

105 x 26 mm **57-1221-01**
 105 x 28 mm **57-1221-02**
 105 x 33 mm **57-1221-03**



Halter allein
 Retractors only
 Valvas suelto
 Solo valve

KRISTELLER

115 x 22 mm **57-1222-01**
 115 x 24 mm **57-1222-02**
 115 x 29 mm **57-1222-03**



Satz
 Set
 Juego
 Set

KRISTELLER

Fig. 1 **57-1230-01**
 Fig. 2 **57-1230-02**
 Fig. 3 **57-1230-03**



Spekula allein, flach
 Specula only, flat hollow
 Espéculos suelto, con huecos planos
 Solo speculi, piatta

KRISTELLER

110 x 27 mm **57-1231-01**
 110 x 30 mm **57-1231-02**
 110 x 36 mm **57-1231-03**

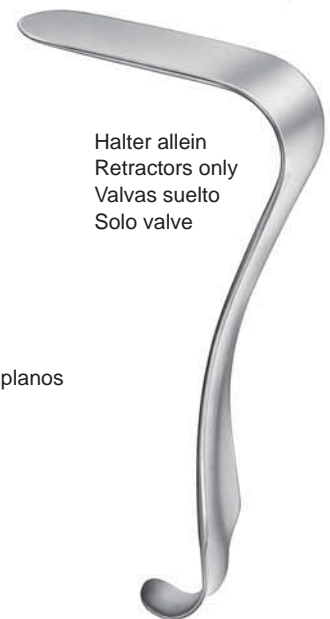

Halter allein
 Retractors only
 Valvas suelto
 Solo valve

KRISTELLER

115 x 23 mm **57-1232-01**
 115 x 26 mm **57-1232-02**
 115 x 32 mm **57-1232-03**

Scheidenspekula
Vaginal Specula
Espéculos vaginales
Speculi vaginali



Satz
Set
Juego
Set

KRISTELLER

Fig. 0 **57-1234-00**
Fig. 1 **57-1234-01**
Fig. 2 **57-1234-02**
Fig. 3 **57-1234-03**



Spekula allein
Specula only
Espéculos suelto
Solo speculi

KRISTELLER

70 x 15 mm **57-1235-00**
70 x 27 mm **57-1235-01**
80 x 30 mm **57-1235-02**
90 x 36 mm **57-1235-03**

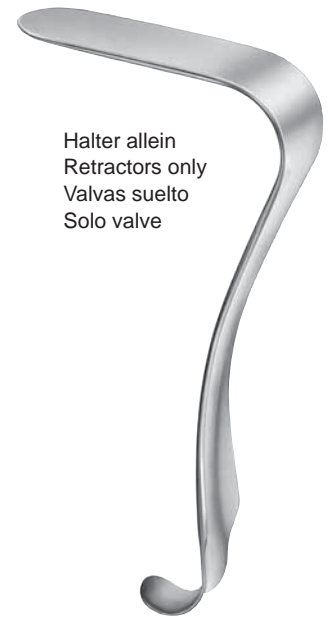

Halter allein
Retractors only
Valvas suelto
Solo valve

KRISTELLER

75 x 10 mm **57-1236-00**
75 x 23 mm **57-1236-01**
85 x 26 mm **57-1236-02**
100 x 32 mm **57-1236-03**



konisch, für Jungfrauen
conical blades, vor virgins
valvos cónicos, para virgenes
valve coniche, per vergini

Satz
Set
Juego
Set

KRISTELLER

Fig. 00 **57-1237-01**
Fig. 0 **57-1237-02**



Spekula allein
Specula only
Espéculos suelto
Solo speculi

KRISTELLER

105 x 18 mm **57-1238-01**
105 x 21 mm **57-1238-02**



Halter allein
Retractors only
Valvas suelto
Solo valve

KRISTELLER

110 x 14 mm **57-1239-01**
110 x 17 mm **57-1239-02**

Scheidenspekula
Vaginal Specula
Espéculos vaginales
Speculi vaginali



leicht hohl
slightly-concave
ligeremente concavos
leggeremente concavi

Fig	a x b	
1	55 x 35 mm	57-1260-01
2	85 x 35 mm	57-1260-02
3	115 x 35 mm	57-1260-03

1	55 x 45 mm	57-1261-01
2	85 x 45 mm	57-1261-02
3	115 x 45 mm	57-1261-03
4	160 x 45 mm	57-1261-04

1	55 x 60 mm	57-1262-01
2	85 x 60 mm	57-1262-02
3	115 x 60 mm	57-1262-03
4	160 x 60 mm	57-1262-04

DOYEN
23,0 cm, 9"

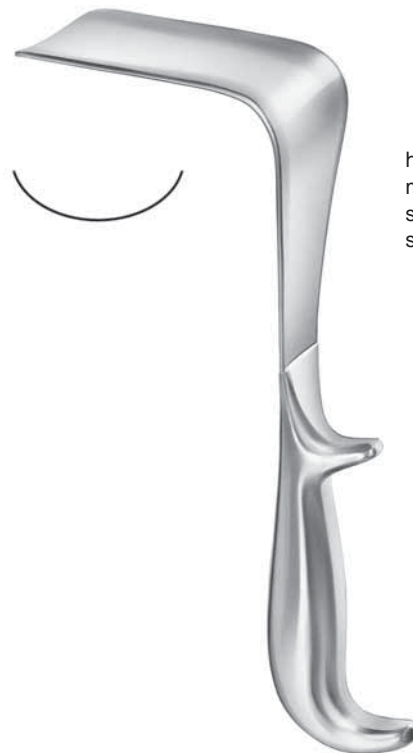

halb-hohl
medium-concave
semi-concavos
semi-concavi

Fig	a x b	
1	55 x 35 mm	57-1264-01
2	85 x 35 mm	57-1264-02
3	115 x 35 mm	57-1264-03

1	55 x 45 mm	57-1265-01
2	85 x 45 mm	57-1265-02
3	115 x 45 mm	57-1265-03

1	55 x 60 mm	57-1266-01
2	85 x 60 mm	57-1266-02
3	115 x 60 mm	57-1266-03

DOYEN
23,0 cm, 9"

Scheidenspekula
Vaginal Specula
Espéculos vaginales
Speculi vaginali



Satz
Set
Juego
Set

KALLMORGEN
70 x 40 mm **57-1270-01**
90 x 40 mm **57-1270-02**



Spekula allein
Specula only
Espéculos suelto
Solo speculi

KALLMORGEN
70 x 40 mm **57-1271-01**
90 x 40 mm **57-1271-02**

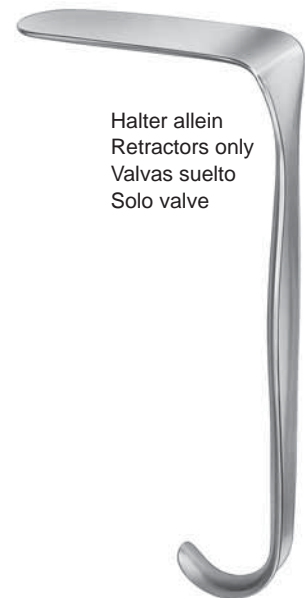

Halter allein
Retractors only
Valvas suelto
Solo valve

KALLMORGEN
70 x 40 mm **57-1272-01**
90 x 40 mm **57-1272-02**



70 x 15 mm

KRISTELLER
17,0 cm, 6³/₄"
57-1275-17



75 x 39 mm

KALLMORGEN
17,0 cm, 6³/₄"
57-1290-17



JACKSON
75 x 38 mm **57-1290-01**
90 x 38 mm **57-1290-02**
100 x 38 mm **57-1290-03**

Scheidenspekula
Vaginal Specula
Espéculos vaginales
Speculi vaginali

76 x 25 mm



70 x 22 mm

BREISKY
14,0 cm, 5½"
57-1292-01

82 x 30 mm



76 x 25 mm

BREISKY
14,0 cm, 5½"
57-1292-02

95 x 38 mm



82 x 30 mm

BREISKY
17,0 cm, 6¾"
57-1292-03

102 x 44 mm



95 x 38 mm

BREISKY
17,0 cm, 6¾"
57-1292-04

**Scheidenspekula und -halter
Vaginal Specula and Retractors
Espéculos y valvas vaginales
Speculi e valve vaginali**

SIMS
57-1294-00
Satz, Set, Juego, Set



70 x 30 mm

65 x 25 mm

SIMS
12,5 cm, 5"
57-1294-01



70 x 35 mm

70 x 30 mm

SIMS
15,0 cm, 6"
57-1294-02



90 x 40 mm

85 x 35 mm

SIMS
17,5 cm, 7"
57-1294-03



Spekula allein
Specula only
Espéculos suelto
Solo speculi

MATHIEU
100 x 13-23 mm **57-1300-01**
100 x 16-30 mm **57-1300-02**



Halter allein
Retractors only
Valvas suelto
Solo valve

MATHIEU
100 x 11-21 mm **57-1301-01**
100 x 14-27 mm **57-1301-02**



LANDAU
100 x 28 mm **57-1305-01**
100 x 38 mm **57-1305-02**

Scheidenspekula
 Vaginal Specula
 Espéculos vaginales
 Speculi vaginali



100 x 20 mm	57-1307-20
100 x 25 mm	57-1307-25
100 x 30 mm	57-1307-30
100 x 35 mm	57-1307-35
100 x 40 mm	57-1307-40
<hr/>	
130 x 20 mm	57-1308-20
130 x 25 mm	57-1308-25
130 x 30 mm	57-1308-30
130 x 35 mm	57-1308-35
130 x 40 mm	57-1308-40
<hr/>	
155 x 40 mm	57-1309-40

BREISKY

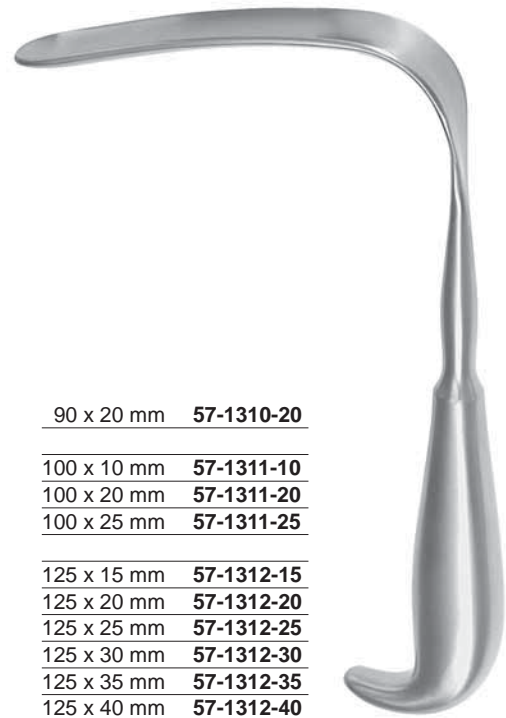

90 x 20 mm	57-1310-20
<hr/>	
100 x 10 mm	57-1311-10
100 x 20 mm	57-1311-20
100 x 25 mm	57-1311-25
<hr/>	
125 x 15 mm	57-1312-15
125 x 20 mm	57-1312-20
125 x 25 mm	57-1312-25
125 x 30 mm	57-1312-30
125 x 35 mm	57-1312-35
125 x 40 mm	57-1312-40

MATZENAUER



85 x 17 mm

BRAUN, MODIF.
 19,0 cm, 7½"
57-1313-19



60 x 30 mm

DOYEN
 23,0 cm, 9"
57-1315-23



80 x 30 mm

DOYEN
 25,0 cm, 9"
57-1315-25



95 x 38 mm

WERTHEIM
 30,0 cm, 12"
57-1317-30

Endospekula, Lateral-Spekulum, Intrauterinsonde
 Endospecula, Lateral Speculum, Intrauterine Probe
 Endospecúlos, Espéculo lateral, Sonda intra-uterina
 Endospeculi, Speculo lateral, Sonde intrauterine



KOGAN
 24,0 cm, 9½"

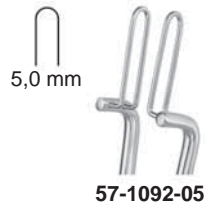
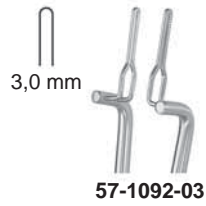

KOGAN
 24,0 cm, 9½"

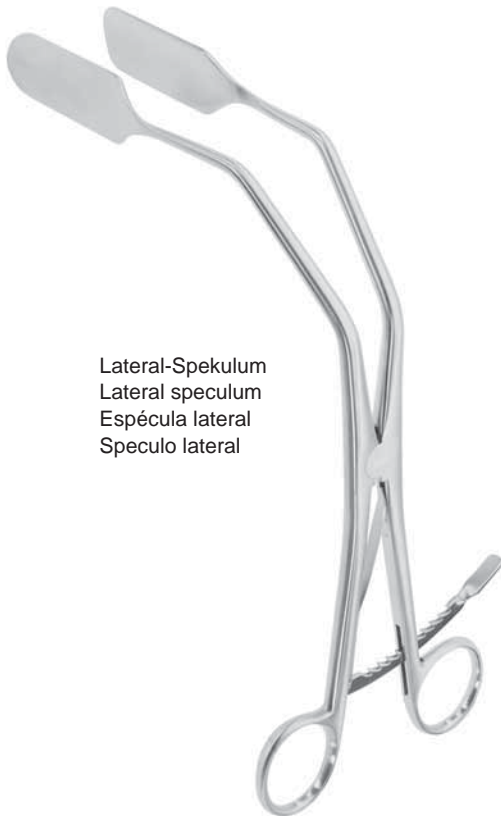
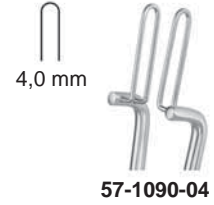

Lateral-Spekulum
 Lateral speculum
 Espécula lateral
 Speculo lateral

25,0 cm, 10"
57-1096-25

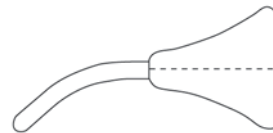

COHEN
57-1530-01

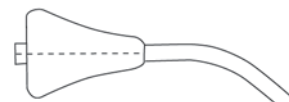

COHEN
57-1530-02



COHEN
57-1530-00

**Uterus-Dilatatoren
Uterine Dilators
Dilatadores uterinos
Dilatatori uterini**



HEGAR
18,5 cm, 7¼"

Ø 1,0 mm	57-1350-01
Ø 2,0 mm	57-1350-02
Ø 3,0 mm	57-1350-03
Ø 4,0 mm	57-1350-04
Ø 5,0 mm	57-1350-05
Ø 6,0 mm	57-1350-06
Ø 7,0 mm	57-1350-07
Ø 8,0 mm	57-1350-08
Ø 9,0 mm	57-1350-09
Ø 10,0 mm	57-1350-10
Ø 11,0 mm	57-1350-11
Ø 12,0 mm	57-1350-12
Ø 13,0 mm	57-1350-13
Ø 14,0 mm	57-1350-14
Ø 15,0 mm	57-1350-15
Ø 16,0 mm	57-1350-16
Ø 17,0 mm	57-1350-17
Ø 18,0 mm	57-1350-18
Ø 19,0 mm	57-1350-19
Ø 20,0 mm	57-1350-20
Ø 21,0 mm	57-1350-21
Ø 22,0 mm	57-1350-22
Ø 23,0 mm	57-1350-23
Ø 24,0 mm	57-1350-24
Ø 25,0 mm	57-1350-25
Ø 26,0 mm	57-1350-26



HEGAR
18,5 cm, 7¼"

Ø 1,5 mm	57-1351-01
Ø 2,5 mm	57-1351-02
Ø 3,5 mm	57-1351-03
Ø 4,5 mm	57-1351-04
Ø 5,5 mm	57-1351-05
Ø 6,5 mm	57-1351-06
Ø 7,5 mm	57-1351-07
Ø 8,5 mm	57-1351-08
Ø 9,5 mm	57-1351-09
Ø 10,5 mm	57-1351-10
Ø 11,5 mm	57-1351-11
Ø 12,5 mm	57-1351-12
Ø 13,5 mm	57-1351-13
Ø 14,5 mm	57-1351-14
Ø 15,5 mm	57-1351-15
Ø 16,5 mm	57-1351-16
Ø 17,5 mm	57-1351-17



205 x 105 x 45 mm

HEGAR
57-1350-99
Satz, Set, Juego, Set
Ø 1,0 - Ø 26,0
(26 dilators)

HEGAR
57-1350-98
Satz, Set, Juego, Set
Ø 4,0 - Ø 17,0
(14 dilators)



HEGAR
 20,0 cm, 8"

Ø 1,0 / 2,0 mm	57-1354-01
Ø 3,0 / 4,0 mm	57-1354-03
Ø 5,0 / 6,0 mm	57-1354-05
Ø 7,0 / 8,0 mm	57-1354-07
Ø 9,0 / 10,0 mm	57-1354-09
Ø 11,0 / 12,0 mm	57-1354-11
Ø 13,0 / 14,0 mm	57-1354-13
Ø 15,0 / 16,0 mm	57-1354-15
Ø 17,0 / 18,0 mm	57-1354-17
Ø 19,0 / 20,0 mm	57-1354-19
Ø 21,0 / 22,0 mm	57-1354-21
Ø 23,0 / 24,0 mm	57-1354-23
Ø 25,0 / 26,0 mm	57-1354-25



HEGAR
57-1354-98
 Satz, Set, Juego, Set
 Ø 3,0 / 4,0 - Ø 17,0 / 18,0 mm
 (8 dilators)

HEGAR
57-1354-99
 Satz, Set, Juego, Set
 Ø 1,0 / 2,0 - Ø 25,0 / 26,0 mm
 (13 dilators)



HANK

Ø 4,5 / 5,0 mm	57-1360-05
Ø 5,5 / 6,0 mm	57-1360-06
Ø 6,5 / 7,0 mm	57-1360-07
Ø 7,5 / 8,0 mm	57-1360-08
Ø 8,5 / 9,0 mm	57-1360-09
Ø 9,5 / 10,0 mm	57-1360-10

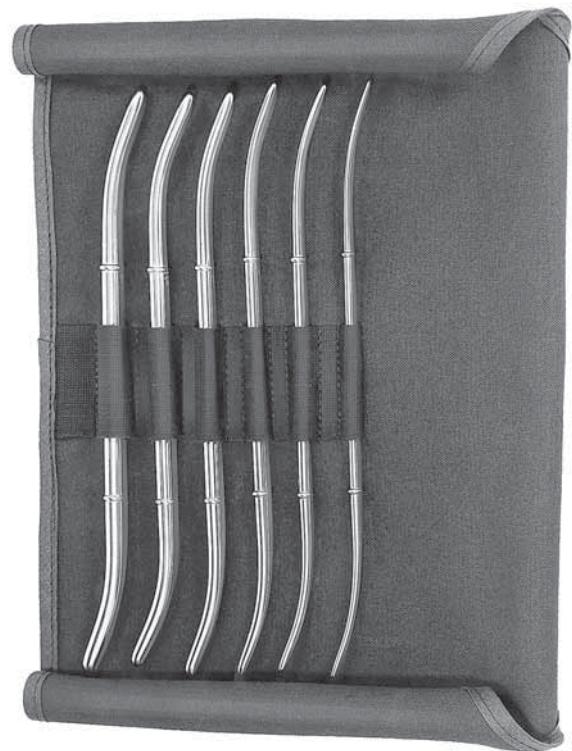

HANK
57-1360-98
 Satz, Set, Juego, Set
 Ø 4,5 / 5,0 - Ø 9,5 / 10,0 mm
 (6 dilators)

Uterus-Dilatatoren, Hakenzangen
Uterine Dilators, Uterine Tenaculum Forceps
Dilatadores uterinos, Pinzas para coger el cuello del útero
Dilatatori uterini, Pinze per abbassare il collo dell'utero



PRATT

Ø 4,5 / 5,0 mm	57-1370-05
Ø 5,5 / 6,0 mm	57-1370-06
Ø 7,5 / 8,0 mm	57-1370-08
Ø 8,5 / 9,0 mm	57-1370-09
Ø 9,5 / 10,0 mm	57-1370-10
Ø 11,5 / 12,0 mm	57-1370-12
Ø 12,5 / 13,0 mm	57-1370-13
Ø 13,5 / 14,0 mm	57-1370-14

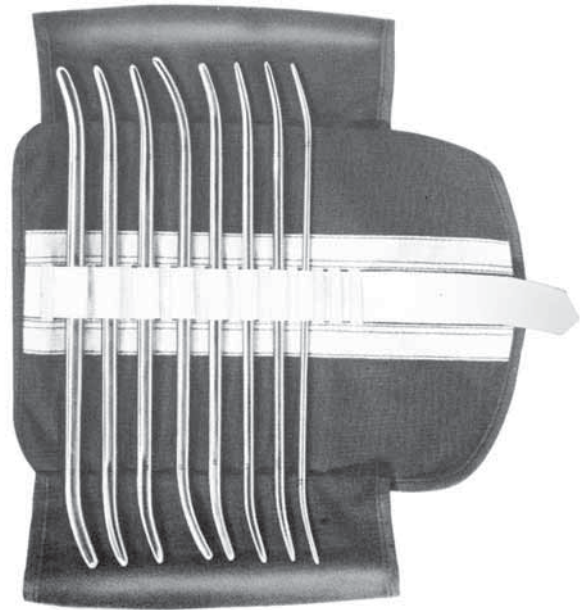

PRATT
57-1370-98
 Satz, Set, Juego, Set
 Ø 4,5 / 5,0 - Ø 13,5 / 14,0 mm
 (8 dilators)



BARRETT
 18,0 cm, 7"
57-1410-18



ADAIR
 19,0 cm, 7½"
57-1412-19



STAUDE-MOORE
 17,0 cm, 6¾"
57-1414-17

Hakenzangen
Uterine Tenaculum Forceps
Pinzas para coger el cuello del útero
Pinze per abbassare il collo dell'utero

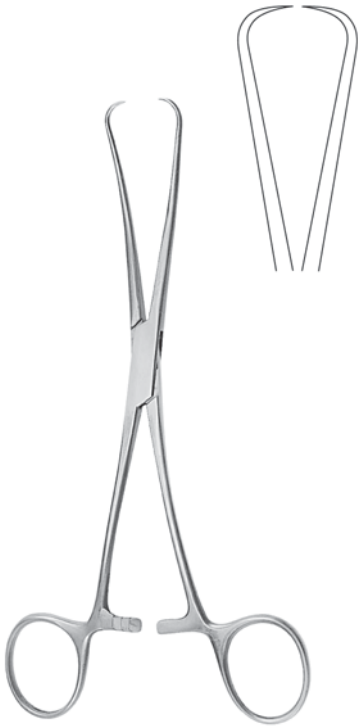

JARCHO
 20,0 cm, 8"
 57-1417-20



SCHROEDER
 25,0 cm, 9³/₄"
 57-1400-25



BRAUN
 25,0 cm, 9³/₄"
 57-1404-25



DUPLAY
 28,0 cm, 11"
 57-1419-28



POZZI
 26,0 cm, 10¹/₄"
 57-1402-26



KAHN
 24,0 cm, 9¹/₂"
 57-1421-24

Hakenzangen
Uterine Tenaculum Forceps
Pinzas para coger el cuello del útero
Pinze per abbassare il collo dell'utero



SKENE
 24,0 cm, 9½"
 57-1423-24



SCHROEDER
 24,0 cm, 9½"
 57-1426-24



SCHROEDER
 24,0 cm, 9½"
 57-1429-24



TEALE
 23,0 cm, 9"
 57-1431-23



JACOBS
 21,0 cm, 8½"
 57-1434-21



JACOBS
 21,0 cm, 8½"
 57-1435-21

Hakenzangen
Uterine Tenaculum Forceps
Pinzas para coger el cuello del útero
Pinze per abbassare il collo dell'utero

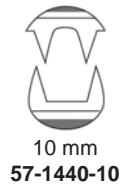
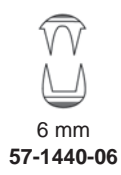

MUSEUX
24,0 cm, 9½"

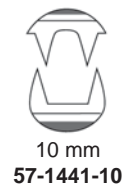

MUSEUX
24,0 cm, 9½"

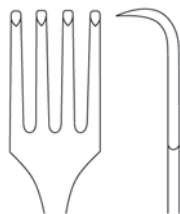

BRAUN
15,5 cm, 6"
57-1442-15



CZERNY
20,5 cm, 8"
57-1444-20



PRATT
28,0 cm, 11"
57-1446-28



IOWA
26,0 cm, 10¼"
57-1449-26

Polypen- und Ovarienzangen, Uterusfaßzangen
 Polypus and Ovum Forceps, Uterine Elevating Forceps
 Pinzas para pólipos uterinos y ovarios, Pinzas para la útero
 Pinze per polipi e ovaie, Pinze per affarrare l'utero



DOYEN
 20,5 cm, 8"
 57-1470-20

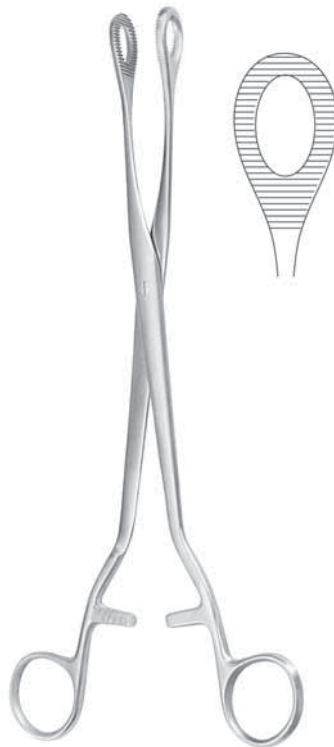

NOTO
 27,0 cm, 10⁵/₈"
 57-1472-27

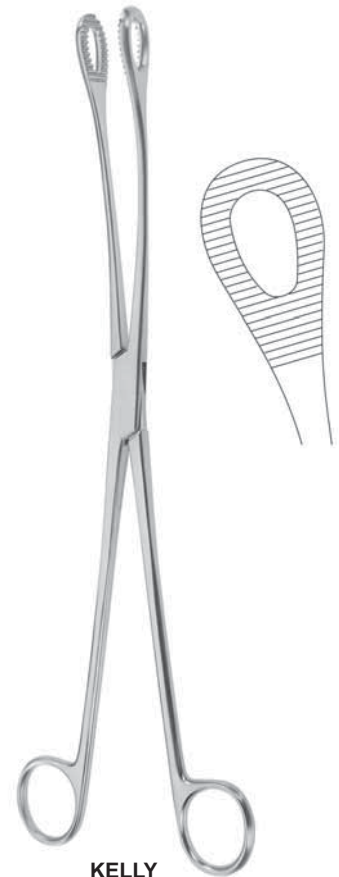

KELLY
 32,0 cm, 12¹/₂"
 57-1475-32



HEYWOOD-SMITH
 25,0 cm, 9³/₄"
 57-1480-25



DARTIGUES
 27,0 cm, 10³/₄"
 57-1482-27



SOMER
 23,0 cm, 9"
 57-1485-23

Uterusfaßzangen, Uterussonden, Zentimetereinteilung
Uterine Elevating Forceps, Uterine Probes, graduated in centimeters
Pinzas para la útero, Histerómetros, graduado en centímetros
Pinze per affarrare l'utero, Isterometri, graduato in cm



COLLIN
 25,0 cm, 9³/₄"
 57-1488-25



BEACHAM
 26,0 cm, 10¹/₄"
 57-1500-26

Amniotom
 Amniotome
 Amniótomo
 Amniotomo



BRAUN
 28,0 cm, 11"
 57-1502-28

Uterus-Depressor
 Uterine depressor
 Depresor uterino
 Depressori uterini



SIMS
 32,0 cm, 12¹/₂"
 57-1510-32

biegsam
 malleable
 maleable
 malleabile



SIMS
 32,0 cm, 12¹/₂"
 57-1511-32



MARTIN
 32,0 cm, 12¹/₂"
 57-1516-32



MARTIN
 32,0 cm, 12¹/₂"
 57-1518-32

biegsam
 malleable
 maleable
 malleabile



VALLEIX
 25,0 cm, 10"
 57-1521-25

Ø 4 mm



SIMPSON
 29,0 cm, 11¹/₂"
 57-1527-29

biegsam
 malleable
 maleable
 malleabile

Ø 4 mm



COLLIN
 28,0 cm, 11"
 57-1529-28

Biopsieküretten
Biopsy Curettes
Curetas para biopsia
Curette per biopsia



KEVORKIAN
 30,0 cm, 12"
 57-1540-30



KEVORKIAN
 30,0 cm, 12"
 57-1542-30



KEVORKIAN
 30,0 cm, 12"
 57-1543-30

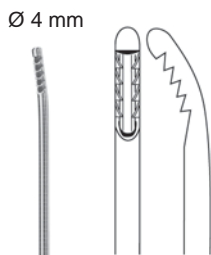

NOVAK
 23,0 cm, 9"
 57-1550-04

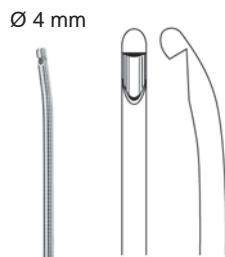

RANDALL
 23,0 cm, 9"
 57-1552-04



MILAN
 29,0 cm, 11½"



Ø 4 mm
 57-1560-04



Ø 6 mm
 57-1560-06



Ø 9 mm
 57-1560-09

Myominstrumente
Myoma Instruments
Instrumentos para mioma
Strumenti per fibroma



25,0 cm, 9³/₄"
57-1570-25



25,0 cm, 9³/₄"
57-1572-25



SIMON
22,0 cm, 8⁵/₈"
57-1574-22



EMMETT
22,0 cm, 8⁵/₈"



57-1576-01



57-1576-02



57-1576-03



57-1576-04



57-1576-05



SEGOND
27,0 cm, 10⁵/₈"
57-1580-27



AYRE
23,0 cm, 9"
57-1583-23

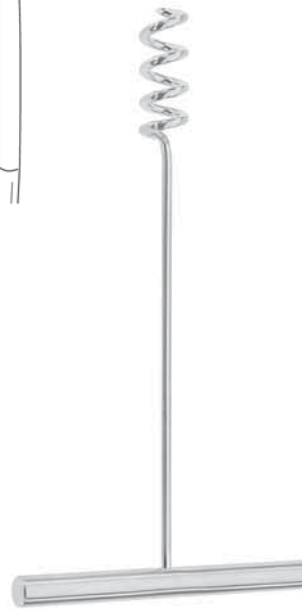

DOYEN
19,0 cm, 7¹/₂"
57-1588-01



DOYEN
17,0 cm, 6³/₄"
57-1588-02

Uterusküretten
Uterine Curettes
Curetas uterinas
Curette uterine

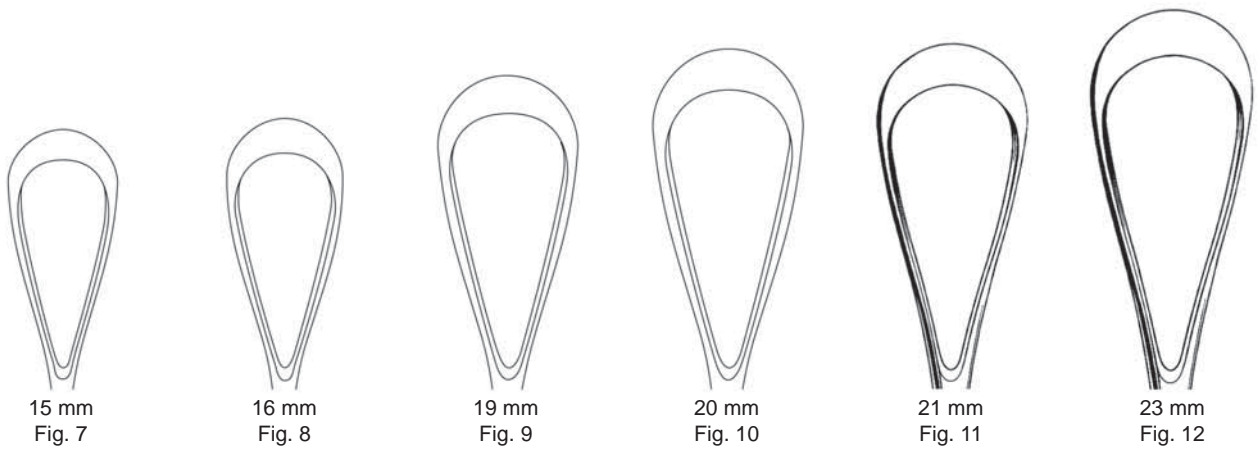
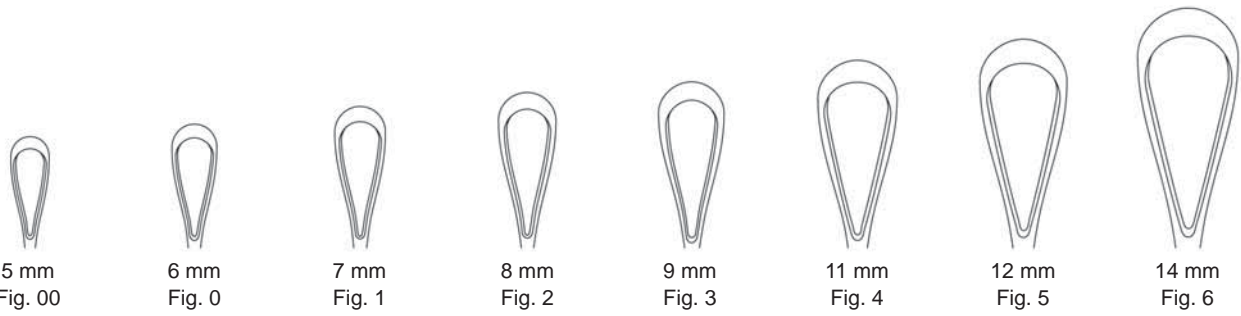

scharf, fest
 sharp, rigid
 cortantes, rígidas
 acute, rigide

Fig. 00	57-1700-05
Fig. 0	57-1700-06
Fig. 1	57-1700-07
Fig. 2	57-1700-08
Fig. 3	57-1700-09
Fig. 4	57-1700-11
Fig. 5	57-1700-12
Fig. 6	57-1700-14
Fig. 7	57-1700-15
Fig. 8	57-1700-16
Fig. 9	57-1700-19
Fig. 10	57-1700-20
Fig. 11	57-1700-21
Fig. 12	57-1700-23

RECAMIER
 26,0 cm, 10 1/4"



scharf, biegsam
 sharp, malleable
 cortantes, maleable
 acute, malleabile

Fig. 00	57-1701-05
Fig. 0	57-1701-06
Fig. 1	57-1701-07
Fig. 2	57-1701-08
Fig. 3	57-1701-09
Fig. 4	57-1701-11
Fig. 5	57-1701-12
Fig. 6	57-1701-14
Fig. 7	57-1701-15
Fig. 8	57-1701-16
Fig. 9	57-1701-19
Fig. 10	57-1701-20
Fig. 11	57-1701-21
Fig. 12	57-1701-23

RECAMIER
 26,0 cm, 10 1/4"

**Uterusküretten
Uterine Curettes
Curetas uterinas
Curette uterine**

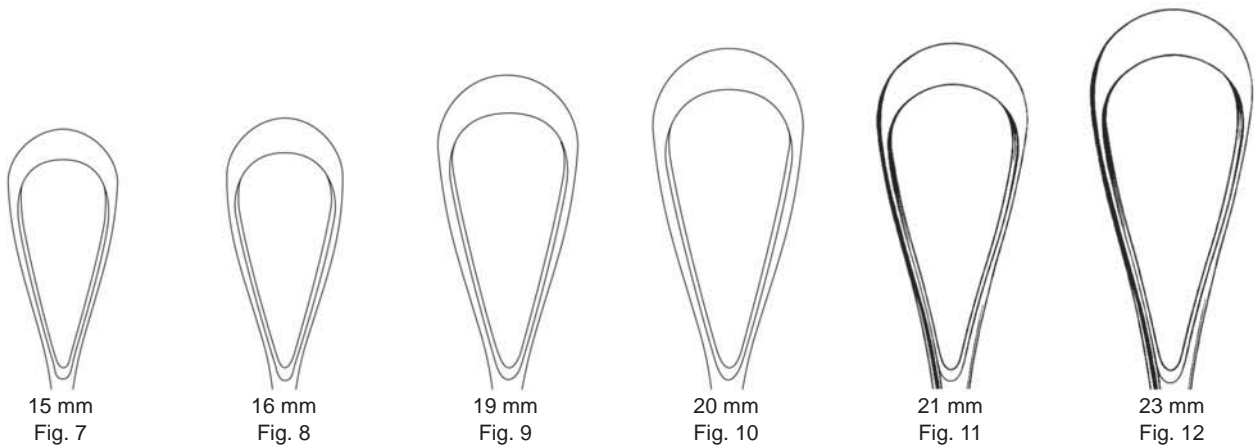
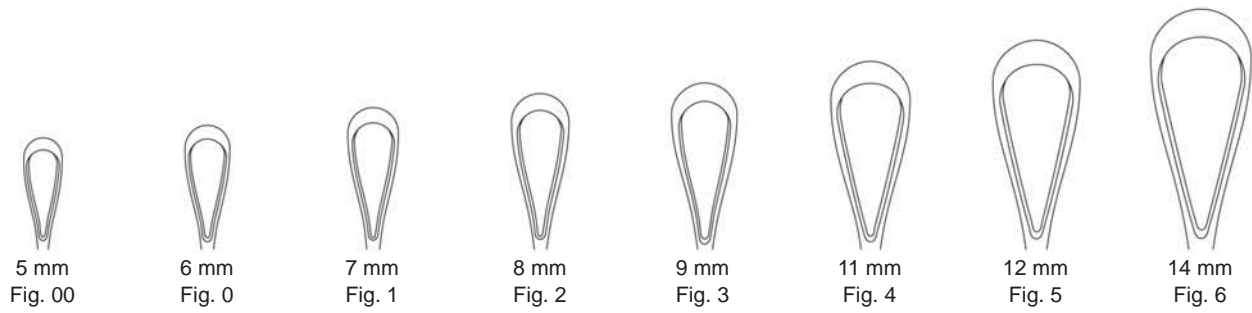

scharf, fest
sharp, rigid
cortantes, rígidas
acute, rigide

Fig. 00	57-1702-05
Fig. 0	57-1702-06
Fig. 1	57-1702-07
Fig. 2	57-1702-08
Fig. 3	57-1702-09
Fig. 4	57-1702-11
Fig. 5	57-1702-12
Fig. 6	57-1702-14
Fig. 7	57-1702-15
Fig. 8	57-1702-16
Fig. 9	57-1702-19
Fig. 10	57-1702-20
Fig. 11	57-1702-21
Fig. 12	57-1702-23

SIMS
26,0 cm, 10¹/₄"



scharf, biegsam
sharp, malleable
cortantes, maleable
acute, malleabile

Fig. 00	57-1703-05
Fig. 0	57-1703-06
Fig. 1	57-1703-07
Fig. 2	57-1703-08
Fig. 3	57-1703-09
Fig. 4	57-1703-11
Fig. 5	57-1703-12
Fig. 6	57-1703-14
Fig. 7	57-1703-15
Fig. 8	57-1703-16
Fig. 9	57-1703-19
Fig. 10	57-1703-20
Fig. 11	57-1703-21
Fig. 12	57-1703-23

SIMS
26,0 cm, 10¹/₄"

Uterusküretten
Uterine Curettes
Curetas uterinas
Curette uterine

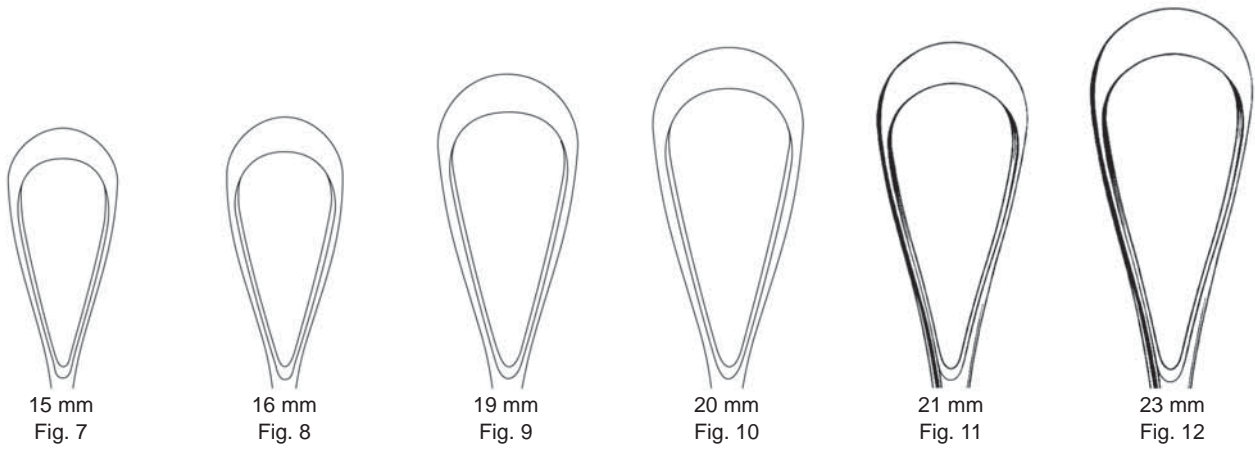
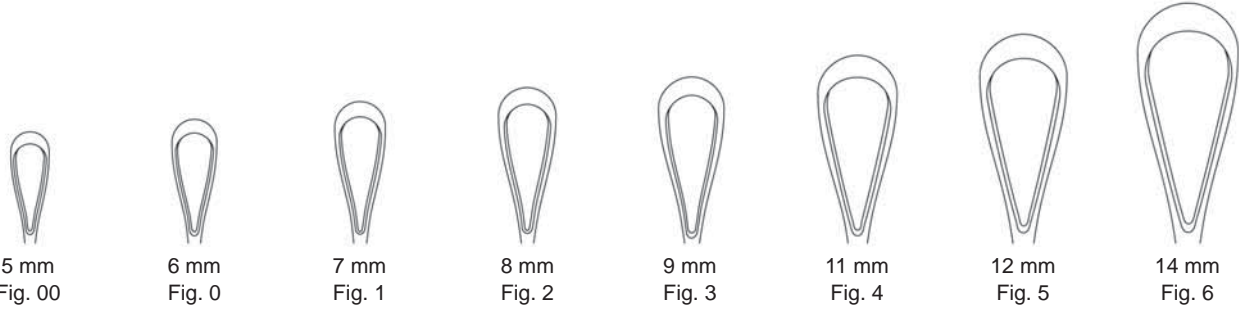

scharf, fest
 sharp, rigid
 cortantes, rígidas
 acute, rigide

Fig. 00	57-1710-05
Fig. 0	57-1710-06
Fig. 1	57-1710-07
Fig. 2	57-1710-08
Fig. 3	57-1710-09
Fig. 4	57-1710-11
Fig. 5	57-1710-12
Fig. 6	57-1710-14
Fig. 7	57-1710-15
Fig. 8	57-1710-16
Fig. 9	57-1710-19
Fig. 10	57-1710-20
Fig. 11	57-1710-21
Fig. 12	57-1710-23

RECAMIER
 31,0 cm, 12¹/₄"



scharf, biegsam
 sharp, malleable
 cortantes, maleable
 acute, malleabile

Fig. 00	57-1711-05
Fig. 0	57-1711-06
Fig. 1	57-1711-07
Fig. 2	57-1711-08
Fig. 3	57-1711-09
Fig. 4	57-1711-11
Fig. 5	57-1711-12
Fig. 6	57-1711-14
Fig. 7	57-1711-15
Fig. 8	57-1711-16
Fig. 9	57-1711-19
Fig. 10	57-1711-20
Fig. 11	57-1711-21
Fig. 12	57-1711-23

RECAMIER
 31,0 cm, 12¹/₄"

**Uterusküretten
Uterine Curettes
Curetas uterinas
Curette uterine**

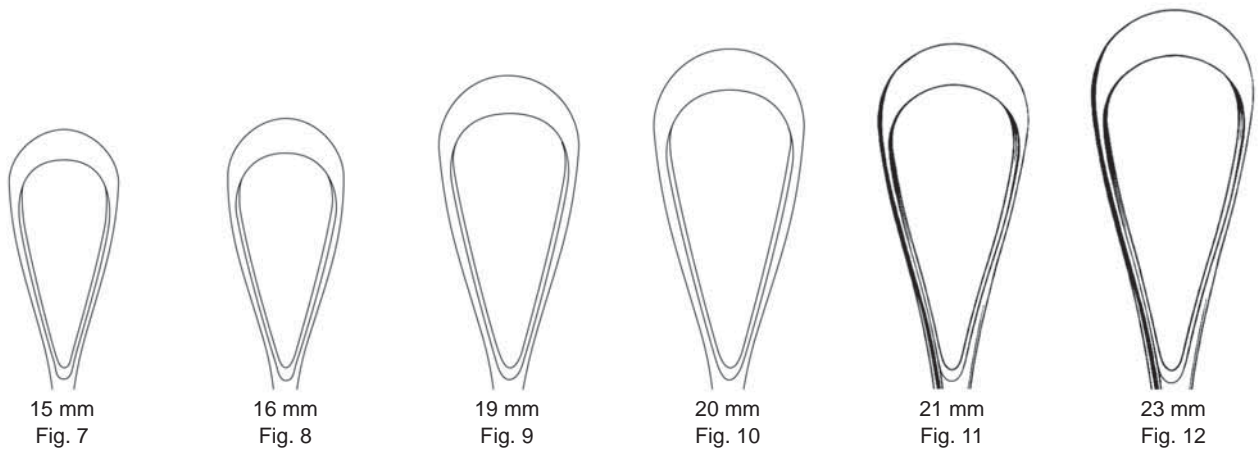
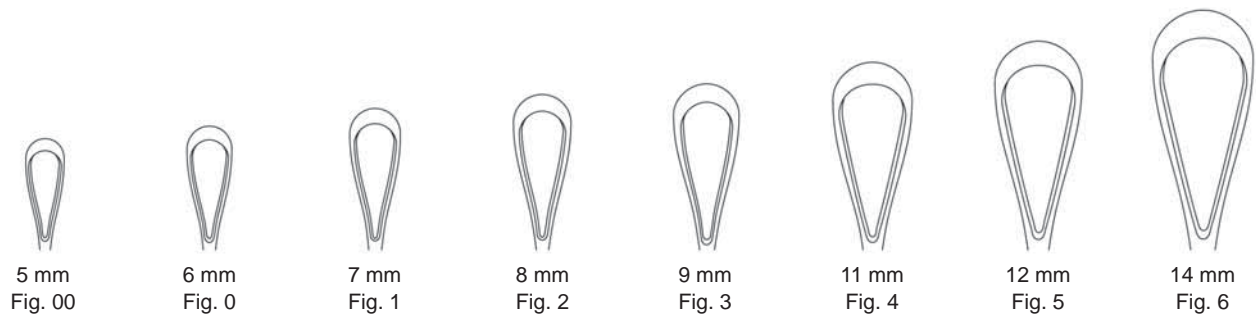

scharf, fest
sharp, rigid
cortantes, rígidas
acute, rigide

Fig. 00	57-1712-05
Fig. 0	57-1712-06
Fig. 1	57-1712-07
Fig. 2	57-1712-08
Fig. 3	57-1712-09
Fig. 4	57-1712-11
Fig. 5	57-1712-12
Fig. 6	57-1712-14
Fig. 7	57-1712-15
Fig. 8	57-1712-16
Fig. 9	57-1712-19
Fig. 10	57-1712-20
Fig. 11	57-1712-21
Fig. 12	57-1712-23

SIMS
31,0 cm, 12¹/₄"



scharf, biegsam
sharp, malleable
cortantes, maleable
acute, malleabile

Fig. 00	57-1713-05
Fig. 0	57-1713-06
Fig. 1	57-1713-07
Fig. 2	57-1713-08
Fig. 3	57-1713-09
Fig. 4	57-1713-11
Fig. 5	57-1713-12
Fig. 6	57-1713-14
Fig. 7	57-1713-15
Fig. 8	57-1713-16
Fig. 9	57-1713-19
Fig. 10	57-1713-20
Fig. 11	57-1713-21
Fig. 12	57-1713-23

SIMS
31,0 cm, 12¹/₄"

Uterusküretten
Uterine Curettes
Curetas uterinas
Curette uterine



30 mm
Fig. 1



35 mm
Fig. 2



40 mm
Fig. 3



scharf, fest
 sharp, rigid
 cortantes, rígidas
 acute, rigide

Fig. 1 **57-1720-30**
 Fig. 2 **57-1720-35**
 Fig. 3 **57-1720-40**

SIMS
 31,0 cm, 12 1/4"



scharf, biegsam
 sharp, malleable
 cortantes, maleable
 acute, malleabile

Fig. 1 **57-1721-30**
 Fig. 2 **57-1721-35**
 Fig. 3 **57-1721-40**

SIMS
 31,0 cm, 12 1/4"

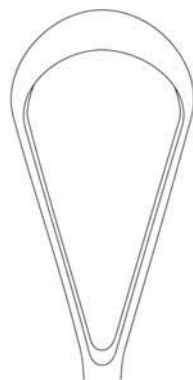

30 mm
 Fig. 1

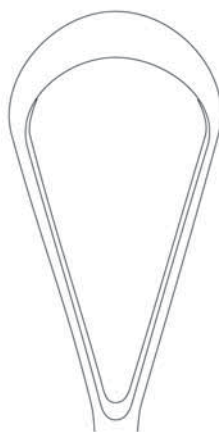

35 mm
 Fig. 2

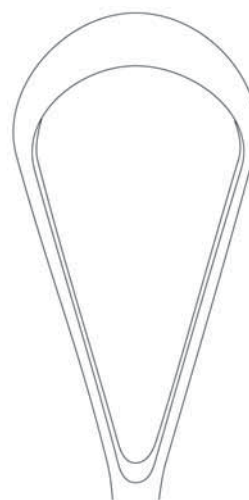

40 mm
 Fig. 3



scharf, fest
 sharp, rigid
 cortantes, rígidas
 acute, rigide

Fig. 1 **57-1722-30**
 Fig. 2 **57-1722-35**
 Fig. 3 **57-1722-40**

BUMM
 31,0 cm, 12¹/₄"



scharf, biegsam
 sharp, malleable
 cortantes, maleable
 acute, malleabile

Fig. 1 **57-1723-30**
 Fig. 2 **57-1723-35**
 Fig. 3 **57-1723-40**

BUMM
 31,0 cm, 12¹/₄"

Uteruslöffel, Uterus-Biopsiezangen
Uterine Scoopes, Cervical Biopsy and Specimen Forceps
Cucharillas uterinas, Pinzas saca-bocados para biopsia
Curette uterine, Pinze per la biopsia cervicale e da prelievo



BLAKE
 27,0 cm, 10⁵/₈"
 57-1750-27



SIMON
 25,0 cm, 9³/₄"

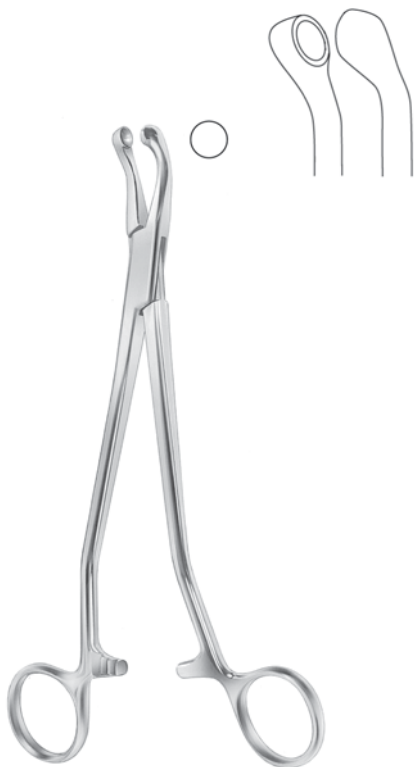
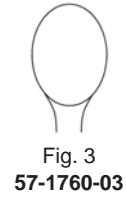
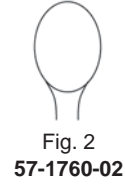
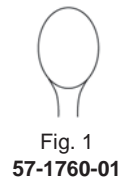

THOMS-GAYLOR
 22,0 cm, 8⁵/₈" 57-1680-22
 24,0 cm, 9¹/₂" 57-1680-24



SCHUBERT
 21,0 cm, 8¹/₄" 57-1682-21
 29,0 cm, 11¹/₂" 57-1682-29



SCHUMACHER-VAN DOREN
 24,0 cm, 9¹/₂" 57-1684-24



Uterus-Biopsiezangen
Cervical Biopsy and Specimen Forceps
Pinzas saca-bocados para biopsia
Pinze per la biopsia cervicale e da prelievo



THOMS-GAYLOR
 24,0 cm, 9½"
 57-1686-24



FAURE
 21,0 cm, 8¼"
 57-1688-21



SCHUBERT
 26,0 cm, 10¼"
 57-1690-26

9 x 3 mm

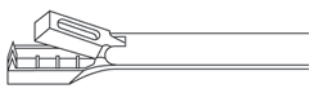

KEVORKIAN
 25,0 cm, 10"
 57-1602-25

4,5 x 8 mm

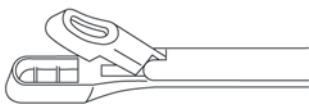

EPPENDORFER
 20,0 cm, 8"
 57-1604-20

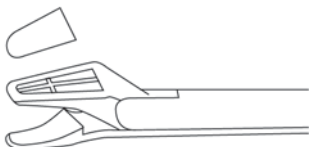

ALEXANDER
 28,0 cm, 11"
 57-1608-28

4,0 mm

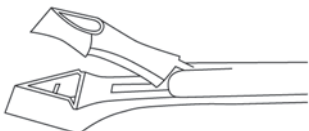

SCHUMACHER
 24,0 cm, 9½"
 57-1610-04

6,0 mm

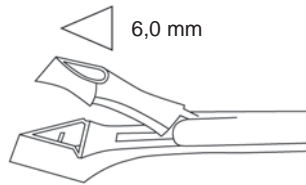

SCHUMACHER
 24,0 cm, 9½"
 57-1610-06

4,5 x 8 mm

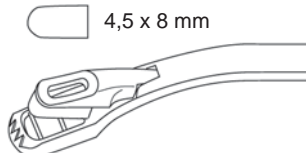

WITTNER
 23,0 cm, 9"
 57-1615-23

4,5 x 8 mm

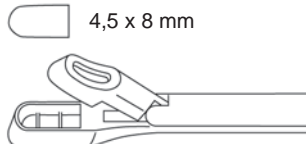

WITTNER
 23,0 cm, 9"
 57-1614-23

Uterus-Biopsiezangen
Cervical Biopsy and Specimen Forceps
Pinzas saca-bocados para biopsia
Pinze per la biopsia cervicale e da prelievo

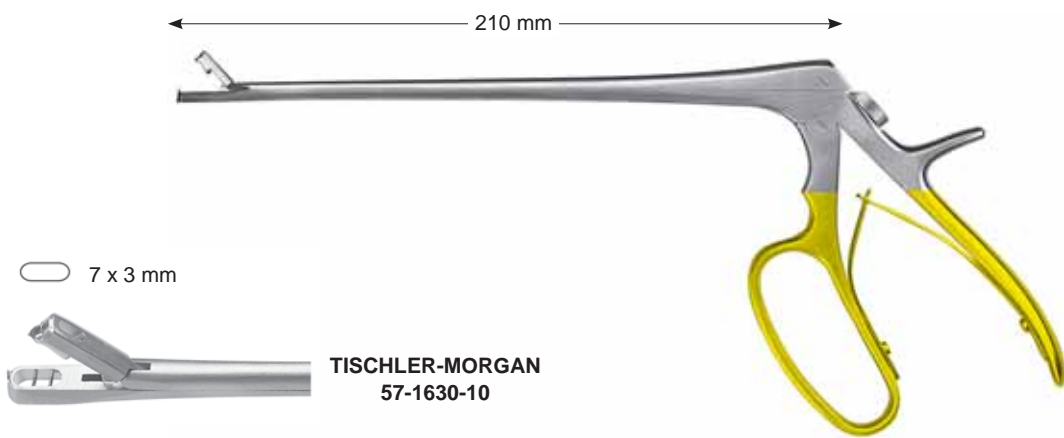
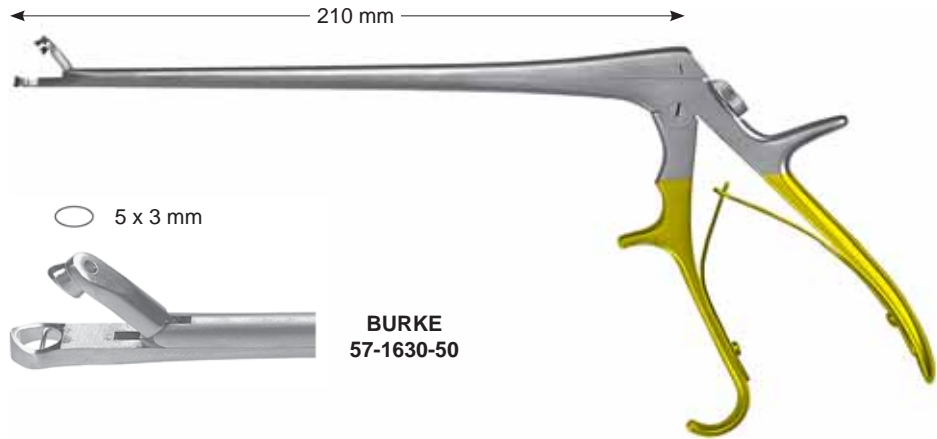

Geburtszangen
 Obstetrical Forceps
 Fórceps para obstétrica
 Forbici per ostetricia



WRIGLEY
 28,0 cm, 11"
 58-1056-28



SIMPSON
 30,0 cm, 11³/₄"
 58-1034-30



SIMPSON-BRAUN
 33,0 cm, 13"
 58-1036-33



SIMPSON-BRAUN
 36,0 cm, 14¹/₈"
 58-1036-36



SIMPSON-LUIKART
 36,0 cm, 14¹/₈"
 58-1046-36



DE LEE
 30,0 cm, 11³/₄"
 58-1058-30



DE LEE
 36,0 cm, 14¹/₈"
 58-1058-36



DE LEE
 38,0 cm, 15³/₈"
 58-1058-38

Geburtszangen
Obstetrical Forceps
Fórceps para obstétrica
Forbici per ostetricia



MC LEAN
36,0 cm, 14¹/₈"
58-1044-36



KIELAND
41,0 cm, 16"
58-1052-41



KIELAND-LUIKART
40,0 cm, 15³/₄"
58-1054-40



PIPER
44,0 cm, 17¹/₄"
58-1060-44



ELLIOT
32,0 cm, 12¹/₂"
58-1080-32



ELLIOT
38,0 cm, 15"
58-1080-38



NAEGELE
36,0 cm, 14¹/₈"
58-1084-36



NAEGELE
40,0 cm, 15³/₄"
58-1084-40

Geburtszangen, Plazentar- und Abortuszangen
 Obstetrical Forceps, Placenta and Ovum Forceps
 Fórceps para obstétrica, Pinzas para aborto y placenta
 Forbici per ostetricia, Pinze per placenta e per ovaie



GREEN-ARMYTAGE
 21,0 cm, 8¹/₄"
 58-1200-21

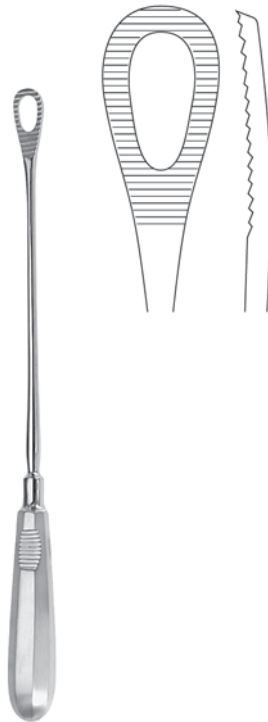

PESTALOZZA
 30,0 cm, 11³/₄"
 58-1252-30



SAENGER
 27,0 cm, 10⁵/₈"
 58-1260-27



SAENGER
 27,0 cm, 10⁵/₈"
 58-1261-27



WINTER
 28,0 cm, 11"



Fig. 1
 58-1244-01



Fig. 2
 58-1244-02



Fig. 3
 58-1244-03



Fig. 1
 58-1245-01

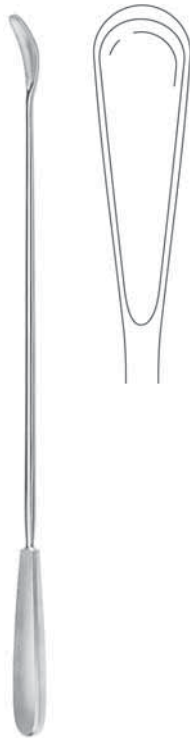

Fig. 2
 58-1245-02



Fig. 3
 58-1245-03

Plazentar- und Abortuszangen
 Placenta and Ovum Forceps
 Pinzas para aborto y placenta
 Pinze per placenta e per ovaie



WALLICH
 42,0 cm, 16½"
 58-1300-42



MARTIN
 34,0 cm, 13¾"
 58-1600-34



BIERER
 33,0 cm, 13"
 58-1236-01



BIERER
 33,0 cm, 13"
 58-1236-02



BIERER
 33,0 cm, 13"
 58-1237-01



BIERER
 33,0 cm, 13"
 58-1237-02

Vorbereitung, Dermatologie
Preparation, Dermatology
Preparación, Dermatología
Preparazione, Dermatologia



Hautstanzen, Nagel Instrumente
Dermal Punches, Nail Instruments
Trépanos cutáneos, Instrumentos para uñas
Trapani dermatici, Strumenti per unghie



Lupusküretten
 Lupus curettes
 Curetas para lupus
 Raschiatoio per lupus



3 mm
59-1110-03



4 mm
59-1110-04



5 mm
59-1110-05

PIFFARD
 14,0 cm, 5³/₄"



KEYES
 12,0 cm, 4³/₄"

2 mm
59-1200-02

3 mm
59-1200-03

4 mm
59-1200-04

5 mm
59-1200-05

6 mm
59-1200-06

7 mm
59-1200-07

8 mm
59-1200-08



KEYES
 12,0 cm, 4³/₄"
59-1210-00

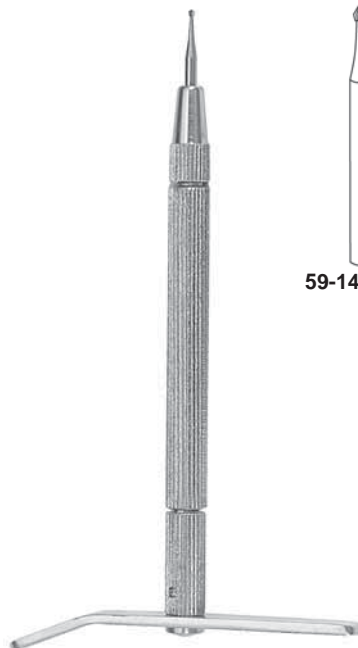

59-1400-00
 komplett, complete,
 completo, completo

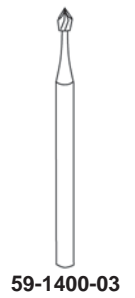
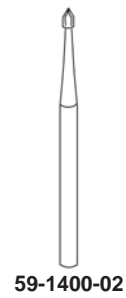
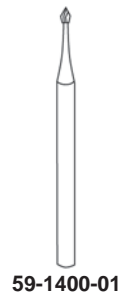

Komedonenquetscher
Comedo Extractors
Saca-comedones
Tiracomedoni



UNNA
14,0 cm, 5³/₄"
59-1000-14



UNNA
14,0 cm, 5³/₄"
59-1002-14



SAALFELD
10,0 cm, 4"
59-1010-10



SAALFELD
14,0 cm, 5³/₄"
59-1012-14



SCHAMBERG
10,0 cm, 4"
59-1020-10



WALTON
14,0 cm, 5³/₄"
59-1030-14



FOX
14,0 cm, 5³/₄"

3 mm
59-1100-03

4 mm
59-1100-04

5 mm
59-1100-05

6 mm
59-1100-06

Lupusküretten
Lupus curettes
Curetas para lupus
Raschiatoio per lupus

Nagel Instrumente
Nail Instruments
Instrumentos para uñas
Strumenti per unghie



59-1420-01

17,0 cm, 6³/₄"
 59-1420-17



59-1430-01

WALTON
 16,0 cm, 6¹/₄"
 59-1430-16



RADOLF
 13,5 cm, 5³/₈"
 59-1500-13



13,5 cm, 5³/₈"
 59-1510-13



13,0 cm, 5"
 59-1600-13



59-1610-01































59-1610-02

14,0 cm, 5¹/₂"

Knochenchirurgie
Bone Surgery
Cirurgía ósea
Chirurgia ossea



Scharfe Löffel
 Bone Currettes
 Cucharillas cortantes
 Curetta per ossa

		
	Fig. 0000 62-1469-04	Fig. 0000 62-1472-04
		
	Fig. 000 62-1469-03	Fig. 000 62-1472-03
		
Fig. 000 62-1467-03	Fig. 00 62-1469-02	Fig. 00 62-1472-02
		
Fig. 00 62-1467-02	Fig. 0 62-1469-01	Fig. 0 62-1472-01
		
Fig. 0 62-1467-01	Fig. 1 62-1469-11	Fig. 1 62-1472-11
		
Fig. 1 62-1467-11	Fig. 2 62-1469-12	Fig. 2 62-1472-12
		
Fig. 1 62-1467-11	Fig. 3 62-1469-13	Fig. 3 62-1472-13
		
Fig. 2 62-1467-12	Fig. 4 62-1469-14	Fig. 4 62-1472-14
		
Fig. 3 62-1467-13	Fig. 5 62-1469-15	Fig. 5 62-1472-15
		
Fig. 4 62-1467-14	Fig. 6 62-1469-16	Fig. 6 62-1472-16
		
SCHEDÉ 17,0 cm, 6 ³ / ₄ "	VOLKMANN 17,0 cm, 6 ³ / ₄ "	BRUNS 17,0 cm, 6 ³ / ₄ "

Scharfe Löffel
 Bone Currettes
 Cucharillas cortantes
 Curetta per ossa

Fig. 00000
 62-1448-04

Fig. 0000
 62-1448-03

Fig. 000
 62-1448-02

Fig. 00
 62-1448-01

Fig. 0
 62-1448-00

LEMPERT
 21,5 cm, 8½"



HALLE
 21,0 cm, 8¼"

Fig. 00
 62-1452-02

Fig. 0
 62-1452-01

Fig. 1
 62-1452-11



Fig. 00
 62-1487-02

Fig. 0
 62-1487-01

Fig. 1
 62-1487-11

Fig. 2
 62-1487-12

DAUBENSPECK
 20,0 cm, 8"

Scharfe Löffel
 Bone Curettes
 Cucharillas cortantes
 Curetta per ossa



WILLIGER
 17,0 cm, 6³/₄"

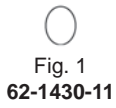

Fig. 1
62-1430-11

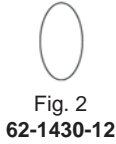

Fig. 2
62-1430-12



WILLIGER
 14,0 cm, 5¹/₂"



Fig. 0
62-1406-00



Fig. 1
62-1406-01



Fig. 2
62-1406-02



MARTINI
 14,0 cm, 5¹/₂"
62-1408-00



Fig. 00/0
62-1408-00
 14,0 cm, 5¹/₂"



Fig. 0/1
62-1408-01
 14,0 cm, 5¹/₂"



Fig. 1/2
62-1408-12
 14,0 cm, 5¹/₂"



VOLKMANN



62-1414-13
 13,0 cm, 5"



62-1414-14
 14,0 cm, 5¹/₂"



62-1414-17
 17,0 cm, 6³/₄"



JANSEN
 15,0 cm, 6"
62-1411-15



JANSEN
 16,0 cm, 6¹/₄"
62-1410-16

Dissektoren, Elevatorien
 Dissectors, Elecators
 Disecadores, Elevadores
 Dissettori, Elevatori

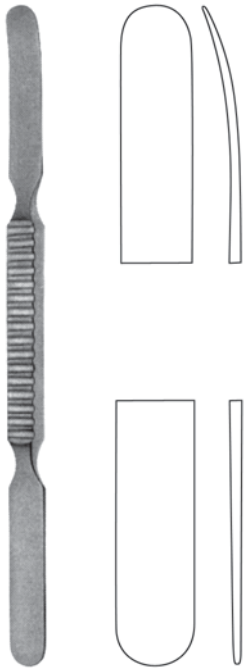

WATSON-CHEYNE
 17,5 cm, 6⁵/₈"
 63-1501-17



MC DONALD
 19,0 cm, 7¹/₂"
 63-1440-19



WILLIGER
 17,0 cm, 6³/₄"
 63-1512-17



WILLIGER
 16,0 cm, 6¹/₄"
 63-1512-16



LANGENBECK
 20,0 cm, 8"
 63-1520-08



LANGENBECK
 20,0 cm, 8"
 63-1520-10

Raspatorien
 Raspatories
 Periostótomos
 Periostotomi

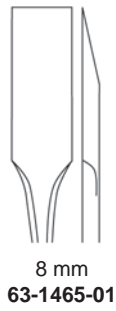

8 mm
 63-1465-01



7 mm
 63-1465-02



7 mm
 63-1465-03



7 mm
 63-1465-04

ADSON
 17,0 cm, 6³/₄"



5 mm



KÖNIG
 15,5 cm, 6"
 63-1476-15

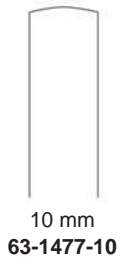

10 mm
 63-1477-10



15 mm
 63-1477-15



20 mm
 63-1477-20

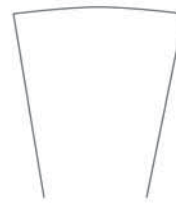

25 mm
 63-1477-25

LAMBOTTE
 21,0 cm, 8¹/₄"

12,5 mm



FARABEUF
 15,0 cm, 6"
 63-1478-15

Raspatorien
Raspatories
Periostótomos
Periostotomi

12,5 mm

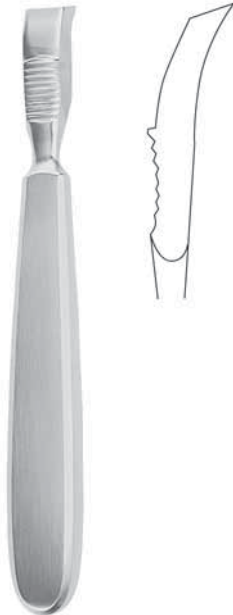

FARABEUF
15,0 cm, 6"
63-1479-15

16,0 mm



LANGENBECK
19,0 cm, 7 1/2"
63-1472-19

15,0 mm



SEDILLOT
21,0 cm, 8 1/4"
63-1488-21

4 mm **63-1480-04**
6 mm **63-1480-06**
8 mm **63-1480-08**

WILLIGER
16,0 cm, 6 1/4"



für Kinder
for children
para niños
per bambini

DOYEN
17,0 cm, 6 3/4"
63-1485-17



für Kinder
for children
para niños
per bambini

DOYEN
17,0 cm, 6 3/4"
63-1487-17



für Erwachsene
for adults
para adultos
per adulti

DOYEN
17,0 cm, 6 3/4"
63-1481-17



für Erwachsene
for adults
para adultos
per adulti

DOYEN
17,0 cm, 6 3/4"
63-1483-17

Flachmeißel, Hohlmeißel, Osteotome
 Chisels, Gouges, Osteotomes
 Cinceles, Gubias, Osteótomos
 Scalpelli, Sgorbie, Osteotomi



8,0 mm	64-1300-08
10,0 mm	64-1300-10
12,0 mm	64-1300-12
14,0 mm	64-1300-14
16,0 mm	64-1300-16

13,5 cm, 5³/₈"



8,0 mm	64-1301-08
10,0 mm	64-1301-10
12,0 mm	64-1301-12
14,0 mm	64-1301-14
16,0 mm	64-1301-16

13,5 cm, 5³/₈"



8,0 mm	64-1302-08
10,0 mm	64-1302-10
12,0 mm	64-1302-12
14,0 mm	64-1302-14
16,0 mm	64-1302-16

13,5 cm, 5³/₈"



3,0 mm	64-1334-03
4,0 mm	64-1334-04
5,0 mm	64-1334-05
6,0 mm	64-1334-06

PARTSCH
 13,5 cm, 5³/₈"



3,0 mm	64-1336-03
4,0 mm	64-1336-04
5,0 mm	64-1336-05
6,0 mm	64-1336-06

PARTSCH
 13,5 cm, 5³/₈"



10,0 mm	64-1361-10
15,0 mm	64-1361-15
20,0 mm	64-1361-20
25,0 mm	64-1361-25

STILLE
 20,0 cm, 8"

Flachmeißel, Hohlmeißel, Osteotome
 Chisels, Gouges, Osteotomes
 Cinceles, Gubias, Osteótomos
 Scalpelli, Sgorbie, Osteotomi



10,0 mm	64-1360-10
15,0 mm	64-1360-15
20,0 mm	64-1360-20
25,0 mm	64-1360-25

STILLE
 20,0 cm, 8"



10,0 mm	64-1362-10
15,0 mm	64-1362-15
20,0 mm	64-1362-20
25,0 mm	64-1362-25

STILLE
 20,0 cm, 8"



4,0 mm	64-1318-04
6,0 mm	64-1318-06
8,0 mm	64-1318-08
10,0 mm	64-1318-10
12,0 mm	64-1318-12
14,0 mm	64-1318-14

ALEXANDER
 18,0 cm, 7"



4,0 mm	64-1319-04
6,0 mm	64-1319-06
8,0 mm	64-1319-08
10,0 mm	64-1319-10
12,0 mm	64-1319-12
14,0 mm	64-1319-14

ALEXANDER
 18,0 cm, 7"



6,0 mm	64-1350-06
9,0 mm	64-1350-09
13,0 mm	64-1350-13
16,0 mm	64-1350-16
19,0 mm	64-1350-19
25,0 mm	64-1350-25
32,0 mm	64-1350-32

SMITH-PETERSEN
 20,0 cm, 8"



6,0 mm	64-1351-06
9,0 mm	64-1351-09
13,0 mm	64-1351-13
16,0 mm	64-1351-16
19,0 mm	64-1351-19
25,0 mm	64-1351-25
32,0 mm	64-1351-32

SMITH-PETERSEN
 20,0 cm, 8"

Flachmeißel, Hohlmeißel, Osteotome, Hämmer
 Chisels, Gouges, Osteotomes, Mallets
 Cinceles, Gubias, Osteótomos, Martillos
 Scalpelli, Sgorbie, Osteotomi, Martelli



9,0 mm	64-1352-09
14,0 mm	64-1352-14
16,0 mm	64-1352-16
19,0 mm	64-1352-19
25,0 mm	64-1352-25

SMITH-PETERSEN
20,0 cm, 8"



9,0 mm	64-1353-09
14,0 mm	64-1353-14
16,0 mm	64-1353-16
19,0 mm	64-1353-19
25,0 mm	64-1353-25

SMITH-PETERSEN
20,0 cm, 8"



6,0 mm	64-1450-06
15,0 mm	64-1450-15
20,0 mm	64-1450-20
25,0 mm	64-1450-25
30,0 mm	64-1450-30
38,0 mm	64-1450-38
44,0 mm	64-1450-44
50,0 mm	64-1450-50

LAMBOTTE
24,0 cm, 9 1/2"



6,0 mm	64-1451-06
15,0 mm	64-1451-15
20,0 mm	64-1451-20
25,0 mm	64-1451-25
30,0 mm	64-1451-30
38,0 mm	64-1451-38
44,0 mm	64-1451-44
50,0 mm	64-1451-50

LAMBOTTE
24,0 cm, 9 1/2"

Ø 30 mm
220 g



COLLIN
20,0 cm, 8"
61-1132-20

Ø 22 mm
200 g



mit Bleifüllung
lead filled head
cabezal relleno de plomo
testa di piombo

PARTSCH
18,0 cm, 7"
61-1145-18

Ø 45 mm
300 g



BERGMANN
24,0 cm, 9 1/2"
61-1201-24

Sterilisation
Sterilization
Esterilización
Sterilizzazione



Sterilisierzangen
Sterilizing Forceps
Pinzas para esterilización
Pinze per sterilizzazione



20,0 cm, 8"
76-1160-20



CHEATTLE
27,0 cm, 10⁵/₈"
76-1163-27



ROGGE
23,0 cm, 9"
76-1164-23



PYE-SMITH (HARRISON)
30,0 cm, 12"
76-1166-30



MAYO
14,0 cm, 5¹/₂"
76-1151-14



BUNT
12,0 cm, 4³/₄"
76-1154-12



Ø 75 x 130 mm	76-1142-06
Ø 75 x 175 mm	76-1142-07
Ø 100 x 175 mm	76-1142-08
Ø 100 x 200 mm	76-1142-09



Ø 40,0 mm	76-1130-04
Ø 60,0 mm	76-1130-06
Ø 80,0 mm	76-1130-08
Ø 100,0 mm	76-1130-10
Ø 120,0 mm	76-1130-12
Ø 150,0 mm	76-1130-15



165 x 55 mm	0,75 l	76-1133-00
175 x 70 mm	1,00 l	76-1133-10
225 x 100 mm	2,00 l	76-1133-20
240 x 95 mm	2,75 l	76-1133-30
260 x 120 mm	4,00 l	76-1133-40
290 x 100 mm	5,00 l	76-1133-50
315 x 150 mm	5,50 l	76-1133-60
325 x 135 mm	8,00 l	76-1133-70
360 x 165 mm	12,00 l	76-1133-80
415 x 150 mm	14,00 l	76-1133-90



170 mm	76-1140-17
250 mm	76-1140-25
275 mm	76-1140-27

Schalen
Trays
Bandejas
Bacinelle



200 x 150 x 25 mm	76-1200-01
260 x 180 x 30 mm	76-1200-02
300 x 220 x 30 mm	76-1200-03
350 x 220 x 40 mm	76-1200-04
220 x 170 x 50 mm	76-1200-05
280 x 200 x 50 mm	76-1200-06
320 x 240 x 50 mm	76-1200-07
370 x 270 x 50 mm	76-1200-08
420 x 320 x 50 mm	76-1200-09



76-1300-00
 Ø 65 x 17 mm
 Außen- und Innendose
 Exterior and interior box
 Caja exterior e interior
 Scatola esterna es interiore

76-1300-01
 Ø 62 x 13 mm
 Innendose allein
 Interior box only
 Caja interior, suelta
 Scatola interiore sola



25 ccm
76-1310-25



50 ccm
76-1310-50

**Bürstenspender
Brush Dispensers
Distribuidores de cepillos
Distributori di spazzole**

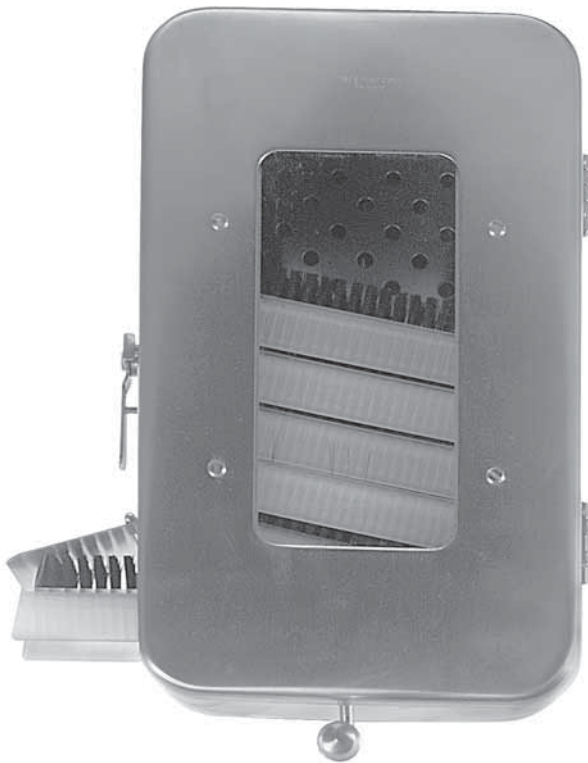

Bürstenspender für 10 Bürsten
Brush dispenser for 10 brushes
Distribuidor de cepillos para 10 cepillos
Distributore per 10 spazzole
260 x 155 x 65 mm
76-1800-01

Bürstenspender für 20 Bürsten
Brush dispenser for 20 brushes
Distribuidor de cepillos para 20 cepillos
Distributore per 20 spazzole
270 x 240 x 65 mm
76-1800-02

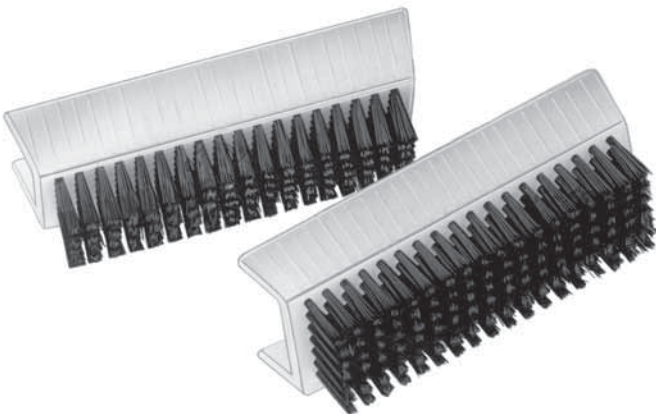

76-1800-10

mehr als 400x autoklavierbar
more than 400 times autoclavable
esterilizable más de 400 veces en autoclave
sterilizzabile piú di 400 volte in autoclave

Alfabetisches Inhaltsverzeichnis
Alphabetical Index

Alphabetisches Inhaltsverzeichnis
Alphabetical Index

ABADIE ABDOMINAL RETRACTOR 115 MM	201	ANDERSON-ADSON, CEREBELLAR RETRACTOR	189
ADAIR, UTERINE TENACULUM FORCPES, 19,0	272	ANDERSON-ADSON, CEREBELLAR RETRACTOR	189
ADLERKREUTZ TISSUE FCPS 2 X 3, 15,0 CM	72	ANDREW-PINCHON SUCTION TUBE, 24,0 CM	222
ADLERKREUTZ TISSUE FCPS 2 X 3, 20,0 CM	72	ANTHONY, SUCTION TUBE, 26,0 CM	222
ADLERKREUTZ TISSUE FCPS 4 X 5, 15,0 CM	72	AUVARD VAG.SPECULA 75 X 38MM	261
ADLERKREUTZ TISSUE FCPS 4 X 5, 20,0 CM	72	AUVARD, VAGINAL SPECULA, W. REMOVABLE	261
ADSON (CONE) RETRACTOR BLUNT 20,0 CM	193	AYRE, MYOMA KNIFE, 23,0 CM	279
ADSON (CONE) RETRACTOR BLUNT 26,0 CM	193	BABCOCK AT INT.TISSUE FORCEPS 16,0 CM	244
ADSON (CONE) RETRACTOR SHARP 20,0 CM	193	BABCOCK AT INT.TISSUE FORCEPS 20,0 CM	244
ADSON (CONE) RETRACTOR SHARP 26,0 CM	193	BABCOCK INT.TISSUE FCPS 16,0 CM	244
ADSON ARTERY FORCEPS CVD 1X2 T 18.5 CM	104	BABCOCK INT.TISSUE FCPS 18,0 CM	244
ADSON ARTERY FORCEPS STR 1X2 T. 18.5 CM	104	BABCOCK INT.TISSUE FCPS 24,0 CM	244
ADSON DRESSING FORCEPS 12,0 CM	66	BABCOCK INTEST.CLAMP FCPS. 16,0 CM	244
ADSON DRESSING FORCEPS 15,0 CM	66	BABCOCK INTEST.CLAMP FCPS. 20,0 CM	244
ADSON FCPS WITH TC 12,0 CM	83	BABCOCK TISSUE FCPS 20,0 CM	244
ADSON FCPS WITH TC 15,0 CM	83	BABY-ADSON ART.FCPS CVD 14,0 CM	108
ADSON FORCEPS CVD 18,5 CM	104	BABY-ADSON ART.FCPS CVD 18,0 CM	108
ADSON FORCEPS STR 18,5 CM	104	BABY-DOYEN INT.CLAMP FCPS. CVD.18,0 CM	245
ADSON FORCEPS TC 1X2 TEETH 12,0 CM	83	BABY-DOYEN INT.CLAMPS FCPS. STR.18,0 CM	245
ADSON FORCEPS TC 1X2 TEETH 15,0 CM	83	BABY-METZENBAUM SCISS TC STR BL/BL 11.5	48
ADSON NEEDLE HOLDER 18,0 CM	125	BABY-METZENBAUM, DISSEC.-SCS., SC	57
ADSON RETRACTOR BLUNT 26,5 CM	189	BABY-METZENBAUM, DISSEC.-SCS., SC	57
ADSON RETRACTOR SHARP 26,5 CM	189	BABY-MIKULICZ PERIT.CLAMP-FCPS 14,0 CM	118
ADSON TISSUE FCPS 1X2 TEETH 15,0 CM	71	BABY-MIXTER ART.FCPS CVD 18,0 CM	108
ADSON TISSUE FCPS 1X2 TEETH, SERRATED,	72	BABY-MIXTER DISS.FCPS SL.CVD 14,0 CM	99
ADSON TISSUE FCPS 2X3 TEETH 12,0 CM	72	BABY-MIXTER DISS.FCPS STR.CVD 14,0 CM	99
ADSON TISSUE FCPS 2X3 TEETH 15,0 CM	72	BABY-OVERHOLT ART.FORCEPS CVD 13,5 CM	102
ADSON, RASPARTORY,	302	BABY-ROUX, RETRACTOR, 13,0 CM	168
ADSON, RASPARTORY,	302	BABY-SENN-MILLER RETRACTOR BLOUNT	163
ADSON, RASPARTORY,	302	BABY-SENN-MILLER RETRACTOR SHARP 15,0	163
ADSON, RASPARTORY,BLUNT	302	BABY-TISCHLER, CERVICAL BIOPSY AND	288
ADSON, SUCTION TUBE 4 MM 21 CM CRV.	223	BACKHAUS TOWEL FORCEPS 11,0 CM	86
ADSON, TISSUE FORCEPS 1X2 T, 12 CM	71	BACKHAUS TOWEL FORCEPS 13,0 CM	86
ADSON-BABY, SELF-RETAINING RETRACTOR,	189	BACKHAUS TOWEL FORCEPS 15,0 CM	86
ADSON-BABY, SELF-RETAINING RETRACTOR,	189	BACKHAUS TOWEL FORCEPS 9,0 CM	86
ADSON-BROWN TISS. FCPS STR 7X7 T.12.0	72	BAINBRIDGE ARTERY FORCEPS CVD 15,0 CM	105
ADSON-BROWN TISS. FCPS STR 7X7 T.15.0	72	BAINBRIDGE ARTERY FORCEPS CVD 18,5 CM	105
ADVENTITIA MICRO SCISSORS SH/SH 14.5 CM	61	BAINBRIDGE ARTERY FORCEPS STR 15,0 CM	105
ADVENTITIA MICRO SCISSORS SH/SH 15,0 CM	61	BAINBRIDGE ARTERY FORCEPS STR 18,5 CM	105
ADVENTITIA MICRO SCISSORS SH/SH 18,0 CM	61	BAKES GALL DUCT DILATOR	236
ADVENTITIA MICRO SCISSORS SH/SH,	61	BAKES GALL DUCT DILATOR FIG.8 30,0 CM	236
ALAN PARKS ANAL RETRACTOR ALONE	253	BAKES GALL DUCT DILATOR,	236
ALAN PARKS ANAL RETRACTOR COMPLETE	253	BAKES, GALL DUCT DILATOR	236
ALAN PARKS, ANAL RETRACTOR, VALVE 25 X	253	BAKES, GALL DUCT DILATOR	236
ALEXANDER CERV.BIOPSY+SPEC.FCPS 28,0 CM	287	BAKES, GALL DUCT DILATOR	236
ALEXANDER CHISEL 10MM 18,0CM	305	BAKES, GALL DUCT DILATOR	236
ALEXANDER CHISEL 12MM 18,0CM	305	BAKES, GALL DUCT DILATOR	236
ALEXANDER CHISEL 14MM 18,0CM	305	BAKES, GALL DUCT DILATOR	236
ALEXANDER CHISEL 4MM 18,0CM	305	BAKES, GALL DUCT DILATOR	236
ALEXANDER CHISEL 6MM 18,0CM	305	BAKES, GALL DUCT DILATOR	236
ALEXANDER CHISEL 8MM 18,0CM	305	BAKES, GALL DUCT DILATOR	236
ALEXANDER, GOUGE, 10MM 18,0CM	305	BAKES, GALL DUCT DILATOR	236
ALEXANDER, GOUGE, 12MM 18,0CM	305	BALFOUR ABDOM.RETRACTOR 90MM	203
ALEXANDER, GOUGE, 14MM 18,0CM	305	BALFOUR ABDOMINAL RETRACTOR US-TYPE,	202
ALEXANDER, GOUGE, 4MM 18,0CM	305	BALFOUR EXCHANGEABLE BLADE 100X35 MM	202
ALEXANDER, GOUGE, 6MM 18,0CM	305	BALFOUR EXCHANGEABLE BLADE 45X80 MM	203
ALEXANDER, GOUGE, 8MM 18,0CM	305	BALFOUR EXCHANGEABLE BLADE 70X35 MM	202
ALLEN, INTESTINAL CLAMP, 15,5 CM	242	BALFOUR EXCHANGEABLE BLADE 70X85 MM	203
ALLEN, INTESTINAL CLAMP, 20,0 CM	242	BALFOUR, ABDOMINAL RETRACTOR, 180 MM,	202
ALLEN, INTESTINAL CLAMP, 23,0 CM	242	BALFOUR, ABDOMINAL RETRACTOR, 200 MM,	202
ALLIS AT TISSUE FORCEPS 16,0 CM	242	BALFOUR, ABDOMINAL RETRACTOR, 250 MM,	202
ALLIS AT TISSUE SEIZING FCPS. 20,0 CM	242	BALFOUR, EXCHANGEABLE BLADE, 80x90 MM	203
ALLIS TISSUE FORCEPS 25,0 CM	242	BARRAQUER MICRO-NEEDLE HOLDER CVD 13.0CM	130
ALLIS, INTESTINAL AND TISSUE GRASPING	242	BARRAQUER, MICRO-NEEDLE HOLDER,	144
ALLIS, INTESTINAL AND TISSUE GRASPING	242	BARRAQUER, MICRO-NEEDLE HOLDER,	144
ALLIS, INTESTINAL AND TISSUE GRASPING	242	BARRAQUER, MICRO-NEEDLE HOLDER, CURVED,	130
ALLIS, INTESTINAL AND TISSUE GRASPING	242	BARRAQUER, MICRO-NEEDLE HOLDER, CURVED,	144
ALLIS, INTESTINAL GRASPING FORCEPS,	243	BARRAQUER, MICRO-NEEDLE HOLDER, CURVED,	144
ALLIS, TISSUE SEIZING FORCEPS	242	BARRAQUER, MICRO-NEEDLE HOLDER, W.	130
ALLIS-ADAIR TIS.SEIZ.FCPS.10X11 15,0 CM	243	BARRAQUER-TROUTMAN, MICRO-NEEDLE	130
ALLIS-BABY, INTESTINAL AND TISSUE	242	BARRAQUER-TROUTMAN, MICRO-NEEDLE	130
ALLISON, LUNG SPATULA, 40 MM, 30,0 CM	186	BARRETT, UTERINE TENACULUM FORCEPS,	272
ALLISON, LUNG SPATULA, 54 MM, 32,0 CM	186	BARRY STERNAL WIRE TWISTING FORCEPS,	139
ALLPORT, RETRACTOR, SHARP, 4x4 PRONGS,	188	BARRY STERNAL, WIRE TWISTING FORCEPS	139
ALM RETRACTOR BLUNT 4X4 PRONGS 10,0 CM	188	BEACHAM AMNIOTOME 26.0CM	277
ALM RETRACTOR BLUNT 4X4 PRONGS 7,0 CM	188	BECKAMNN-ADSON RETRACTOR SHARP 31,0 CM	194
ALM RETRACTOR SHARP 4X4 PRONGS 10,0 CM	188	BECKMANN, SELF-RETAINING RETRACTOR	195
ALM RETRACTOR SHARP 4X4 PRONGS 7,0 CM	188	BECKMANN, SELF-RETAINING RETRACTOR SHARP	194
ALM, RETRACTOR, SEMI-SHARP, 4x4 PRONGS,	188	BECKMANN-ADSON RETRACTOR BLUINT 31 CM	194
ALM, RETRACTOR, SEMI-SHARP, 4x4 PRONGS,	188	BECKMANN-ADSON RETRACTOR BLUNT 31 CM	194

BECKMANN-ADSON RETRACTOR SHARP 31.0 CM	194	BROPHY TISSUE FCPS 1X2 T CVD 20,0 CM	74
BECKMANN-ADSON, SELF-RETAINING RETRACTOR	194	BROPHY TISSUE FCPS 1X2 T STR 20,0 CM	74
BECKMANN-ADSON, SELF-RETAINING RETRACTOR	194	BROWN NEEDLE HOLDER 13.0 CM	125
BECKMANN-ADSON, SELF-RETAINING RETRACTOR	194	BROWN TISSUE FORCEPS 7x7 T 15.0 CM	76
BECKMANN-ADSON, SELF-RETAINING RETRACTOR	194	BROWN TISSUE FORCEPS 7x7 T 20.0 CM	76
BENGOLEA ARTERY FCPS CVD,1X2T,26,0 CM	106	BROWN TISSUE FORCEPS 7x7 T 25.0 CM	76
BENGOLEA ARTERY FCPS STR 1X2T, 26,0 CM	106	BRUNNER LIGATURE CONDUCTOR FIG.1 30.0	151
BENGOLEA ARTERY FCPS STR. 1X2T, 20,0 CM	106	BRUNNER LIGATURE CONDUCTOR FIG.2 30.0	151
BENGOLEA ARTERY FCPS,CVD,1X2T, 20,0 CM	106	BRUNNER LIGATURE CONDUCTOR LEFT 30 CM	151
BENGOLEA ARTERY FORCEPS CURVED 26,0 CM	106	BRUNNER LIGATURE CONDUCTOR RIGHT 30.0 CM	151
BENGOLEA ARTERY FORCEPS STRAIGHT 20,0	106	BRUNNER LIGATURE NEEDLE 25.0 CM	148
BENGOLEA ARTERY FORCEPS STRAIGHT 26,0	106	BRUNNER LIGATURE NEEDLE FIG 1 30.0 CM	148
BENGOLEA ARTERY FORCPES CURVED 20,0 CM	106	BRUNNER LIGATURE NEEDLE FIG.2 30.0 CM	148
BERGMANN MALLETS, 300G, 24,0 CM 45 MM	306	BRUNNER RETRACTOR 100X20 MM 25.0 CM	184
BERGMANN PLASTER OF PARIS SHEARS 23.0	44	BRUNNER RETRACTOR 120X25 MM 25.0 CM	184
BERKELEY, ABDOMINAL RETRACTOR, COMPLETE	203	BRUNNER RETRACTOR 140X25 MM 25.0 CM	184
BERKELEY, ABDOMINAL RETRACTOR, VALVES	203	BRUNNER RETRACTOR 160X30 MM 25.0 CM	184
BERLIN, TUBING CLAMP, 14,5 CM	91	BRUNNER RETRACTOR 180X30 MM 25.0 CM	184
BERNHARD TOWEL FORCEPS 16,5 CM	86	BRUNNER RETRACTOR 80X20 MM 25.0 CM	184
BIER, LUMBAR PUNCTURE NEEDLE,	225	BRUNNER, INTESTINAL CLAMP FORCEPS, 24 CM	248
BIER, LUMBAR PUNCTURE NEEDLE,	225	BRUNNER, INTESTINAL CLAMP FORCEPS, 25 CM	248
BIER, LUMBAR PUNCTURE NEEDLE,	225	BRUNNER, RETRACTOR, FLAT	183
BIER, LUMBAR PUNCTURE NEEDLE,	225	BRUNNER, RETRACTOR, FLAT	183
BIER, LUMBAR PUNCTURE NEEDLE,	225	BRUNNER, RETRACTOR, FLAT	183
BIER, LUMBAR PUNCTURE NEEDLE,	225	BRUNNER, RETRACTOR, FLAT	183
BIER, LUMBAR PUNCTURE NEEDLE,	225	BRUNNER, RETRACTOR, FLAT	183
BIERER PLACENTA FORCEPS STR. 33,0 CM	202	BRUNNER, RETRACTOR, FLAT	183
BIERER PLACENTA FORCEPS CVD. 33,0 CM	292	BRUNNER-FERROZELL LIGATURE CONDUCT.	153
BIERER PLACENTA FORCEPS CVD. 33,0 CM	292	BRUNNER-FERROZELL LIGATURE CONDUCT.	153
BIERER PLACENTA FORCEPS STR. 33,0 CM	292	BRUNS BONE CURETTE, FIG.0 17 CM	298
BIRKETT DISS.AND LIG.FCPS. CVD 19,0 CM	103	BRUNS BONE CURETTE, FIG.00 17 CM	298
BIRKETT DISS.AND LIG.FCPS. STR 19,0 CM	103	BRUNS BONE CURETTE, FIG.000 17 CM	298
BLADE 23X44 MM	198	BRUNS BONE CURETTE, FIG.0000 17 CM	298
BLADE 30X44 MM	198	BRUNS BONE CURETTE, FIG.1 17 CM	298
BLADES ONLY, PAIR, FOR ALAN PARKS	253	BRUNS BONE CURETTE, FIG.2 17 CM	298
BLADES ONLY, PAIR, FOR ALAN PARKS	253	BRUNS BONE CURETTE, FIG.3 17 CM	298
BLAKE GALL STONE FORCEPS CVD 20.0 CM	233	BRUNS BONE CURETTE, FIG.4 17 cm	298
BLAKE GALL STONE FORCEPS STR 20.0 CM	233	BRUNS BONE CURETTE, FIG.5 17 CM	298
BLAKE UTERINE CURETTES,D/E,SHARP/BLUNT	286	BRUNS BONE CURETTE, FIG.6 17 CM	298
BOETTCHER TONSIL SCISSORS CVD 18.0 CM	36	BRUNS PL.-OF-PARIS SHEARS 24.0 CM	45
BONNEY TISSUE FORCEPS 1X2 T. TC 18.0 CM	83	BRUNS PLASTER-OF-PARIS SHEARS 24.0CM	45
BONNEY TISSUE FORCEPS 1X2 TEETH 18.0 CM	76	BRUNS, BANDAGE SCISSORS TC, 24.0 CM	55
BONNEY TISSUE FORCEPS 2X3 TEETH 18.0 CM	76	BRUSH DISPENSER FOR 10 BRUSHES	311
BONNEY, DRESSING FORCEPS, 18.0 CM	68	BRUSH DISPENSER FOR 20 BRUSHES	311
BOYS-ALLIS INT.TISS.FCPS 5X6 T. 15.5 CM	243	BRYANT, SPONGE AND DRESSING FCPS.,	88
BOZEMANN DRESSING FCPS S-SHAPED 26.0 CM	89	BUCK LIGATURE SCISSORS 14.5 CM	33
BOZEMANN DRESSING FCPS STRAIGHT 26.0 CM	88	BUCK LIGATURE SCISSORS 18.0 CM	33
BOZEMANN LOOP TWISTER 21.0 CM	154	BUELAU TROCER 24 CM 8 MM	219
BOZEMANN NEEDLE HOLDER TC S CVD 26.0 CM	139	BUMM, UTERINE CURETTE, SHARP	285
BOZEMANN NEEDLE HOLDER TC S-CVD 20.0 CM	139	BUMM, UTERINE CURETTE, SHARP	285
BOZEMANN NEEDLE HOLDER TC S-CVD 24.0 CM	139	BUMM, UTERINE CURETTE, SHARP	285
BOZEMANN, GYN.-SCS, S-SHAPED, BL/BL,	40	BUMM, UTERINE CURETTE, SHARP, RIGID,	285
BRAITHWAITE, DERMATOMES,	11	BUMM, UTERINE CURETTE, SHARP, RIGID,	285
BRAITHWAITE, DERMATOMES, 30.0 CM	11	BUMM, UTERINE CURETTE, SHARP, RIGID,	285
BRAUN, MODIF. VAGINAL SPECULA	268	BUNT, SAFETY PIN, 12.0 CM	308
BRAUN, UTERINE DEPRESSOR, 28.0 CM	277	BURKE FORCEPS, 21 CM 5X3 MM	288
BRAUN, UTERINE TENACULUM FORCEPS, 4X4	275	BUSCH UMBILICAL SCISSORS 13.0 CM	43
BRAUN, UTERINE TENACULUM FORCEPS, 25,0	273	BUSCH UMBILICAL SCISSORS 16.0 CM	43
BRAUN-STADLER EPISIOTOMY SCS 22.0 CM	43	BYRD SUCTION TUBE 20 CM 1.5MM	223
BRAUN-STADLER EPISIOTOMY SCS 14.0 CM	43	BYRD SUCTION TUBE 20 CM 2.5MM	223
BREISKY VAG.SPEC.BAYONET SH.100X20 MM	268	BYRD SUTION TUBE 15 CM 3.5 MM	223
BREISKY VAG.SPEC.BAYONET SH.100X25 MM	268	CAMPBELL TROCER 16.0 CM 6 MM	220
BREISKY VAG.SPEC.BAYONET SH.100X30 MM	268	CAMPBELL TROCER 16.0 CM 8 MM	220
BREISKY VAG.SPEC.BAYONET SH.100X35 MM	268	CANNULA FOR VAGINAL ANEASTHESIA , Ø 1,0	224
BREISKY VAG.SPEC.BAYONET SH.100X40 MM	268	CANNULA, Ø 1,2 x 80 MM	225
BREISKY VAG.SPEC.BAYONET SH.100X20 MM	268	CANNULA, Ø 1,5 x 80 MM	225
BREISKY VAG.SPEC.BAYONET SH.130X25 MM	268	CANNY RYAL, RETRACTOR, 16 MM, 19,0 CM	169
BREISKY VAG.SPEC.BAYONET SH.130X30 MM	268	CANNY RYAL, RETRACTOR, 20 MM, 19,0 CM	169
BREISKY VAG.SPEC.BAYONET SH.130X35 MM	268	CANNY RYAL, RETRACTOR, 25 MM, 20,0 CM	169
BREISKY VAG.SPEC.BAYONET SH.130X40 MM	268	CAPLAN NASAL SCISSORS CURVED 22.0 CM	35
BREISKY VAG.SPEC.BAYONET SH.155X40 MM	268	CARREL ARTERY FORCEPS STR 10.0 CM	98
BREISKY VAGINAL SPECULA 14,0 CM	266	CARTILAGE SCISS.SAW EDGE 20.0 CM	36
BREISKY VAGINAL SPECULA 14,0 CM	266	CARTILAGE, RESECTION KNIVES,	10
BREISKY VAGINAL SPECULA 17,0 CM	266	CASTROVIEJO, MICRO-NEEDLEHOLDER, W.	131
BREISKY VAGINAL SPECULA 17,0 CM	266	CASTROVIEJO, MICRO-NEEDLEHOLDER, W.	131
BRODIE, DIRECTOR (PROBE), GROOVED, WITH	214	CASTROVIEJO, MICRO-NEEDLEHOLDER, W.	131
BROPHY (SULLIVAN), FINE SCISSORS	31	CASTROVIEJO, MICRO-NEEDLEHOLDER, W.	131
BROPHY (SULLIVAN), FINE SCISSORS CURVED	31	CASTROVIEJO, MICRO-NEEDLEHOLDER, W.	131
BROPHY DRESSING FORCEPS CVD 20,0 CM	68	CASTROVIEJO, MICRO-NEEDLEHOLDER, W.	131
BROPHY DRESSING FORCEPS STR 20,0 CM	67	CASTROVIEJO, MICRO-NEEDLEHOLDER, W.	131

Alfabetisches Inhaltsverzeichnis
Alphabetical Index

CASTROVIEJO, MICRO-NEEDLEHOLDER, W.	131	COOLEY SUCTION TUBE 31.0 CM, Ø 10,0 MM	222
CASTROVIEJO, NEEDLE HOLDER W. TC, CVD.,	144	COOLEY SUCTION TUBE 33.0 CM, Ø 8,0 MM	222
CASTROVIEJO, NEEDLE HOLDER W. TC, CVD.,	144	COOLEY SUCTION TUBE 35.0 CM, Ø 8,0 MM	222
CASTROVIEJO, NEEDLE HOLDER W. TC, CVD.,	144	COOPER LIGATURE NEEDLE 19.0 CM	147
CASTROVIEJO, NEEDLE HOLDER W. TC, CVD.,	144	COOPER LIGATURE NEEDLE 20.0 CM	147
CASTROVIEJO, NEEDLE HOLDER W. TC, STR.,	144	COOPER LIGATURE NEEDLE 20.0 CM	147
CASTROVIEJO, NEEDLE HOLDER W. TC, STR.,	144	COOPER LIGATURE NEEDLE 20.0 CM	147
CASTROVIEJO, NEEDLE HOLDER W. TC, STR.,	144	CORONARY SCISSORS 11.5 CM	39
CASTROVIEJO, NEEDLE HOLDER W. TC, STR.,	144	CORYLLOS RETRACTOR 108X43 MM 24.0 CM	182
CATLIN, AMPUTATION KNIFE,	8	CORYLLOS RETRACTOR 115X65 MM 24.0 CM	182
CATLIN, AMPUTATION KNIFE,	8	CORYLLOS RETRACTOR 82X22 MM 24.0 CM	182
CATLIN, AMPUTATION KNIFE,	8	COTTLE NASAL SCISSORS BLUNT 16.0 CM	35
CHAIN WITH WEIGHT, 645 G, FOR DOYEN	209	COTTLE, NASAL SCS., SC, BL/BL, 16,5 CM	58
CHAPUT ARTERY FORCEPS 3X2 TEETH 13.0 CM	96	COUPLAND, EXCHANGEABLE SUCTION TUBE, Ø	222
CHEATLE STERILIZING FORCEPS 27,0 CM	308	COUPLAND, HANDLE FOR SUCTION TUBE, 17,0	222
CHELSEA EATON, ANOSCOPE,	254	CRAFOORD ARTERY FORCEPS CVD 24.0 CM	104
CHELSEA EATON, ANOSCOPE,	254	CRAFOORD LOBECTOMY SCS CVD BL 30.0 CM	39
CHERON DRESSING FORCEPS 25.0 CM	89	CRAFOORD-SELLORS BRONCHUS FORCEPS	115
CHILDE SUTURE FORCEPS 18.0 CM	155	CRAFOORD-SELLORS BRONCHUS FORCEPS	115
CHILDE SUTURE FORCEPS CLIP 18.0 CM	155	CRAFOORD-SELLORS BRONCHUS FORCEPS	115
CHISEL, 10MM 13,5CM	304	CRILE ARTERY FORCEPS CVD 1X2 T. 14.0 CM	102
CHISEL, 12MM 13,5CM	304	CRILE ARTERY FORCEPS STR 1X2 T. 14.0 CM	102
CHISEL, 14MM 13,5CM	304	CRILE FORCEPS CURVED 14,0 CM	102
CHISEL, 16MM 13,5CM	304	CRILE FORCEPS STR 14.0 CM	102
CHISEL, 8MM 13,5CM	304	CRILE RANKIN ART.FCPS.CVD 1X2T 16 CM	105
CIRCUMCISION INSTRUMENT 8 MM BABY SIZE	240	CRILE RANKIN ART.FCPS.STR 1X2T 16 CM	105
CIRCUMCISION INSTRUMENT 11 MM CHILD	240	CRILE-MURRAY, NEEDLE HOLDER, 15,0 CM	125
CIRCUMCISION INSTRUMENT 13 MM CHILD	240	CRILE-RANKIN, ARTERY FORCEPS, 1X2	103
CIRCUMCISION INSTRUMENT 16 MM ADOL.SIZE	240	CRILE-RANKIN, ARTERY FORCEPS, 1X2	103
CIRCUMCISION INSTRUMENT 21 MM ADOL.SIZE	240	CRILE-RANKIN, ARTERY FORCEPS, CVD, 16,0	103
CIRCUMCISION INSTRUMENT 26 MM MEN'S	240	CRILE-RANKIN, ARTERY FORCEPS, STR, 16,0	103
CIRCUMCISION INSTRUMENT 32 MM MEN'S	240	CRILE-WOOD NEEDLE HOLDER 15,0 CM	125
CLAMP 18.0 CM WITH CLIP	91	CRILE-WOOD NEEDLE HOLDER TC 15.0 CM	134
CLAUS LIGATURE NEEDLE 23.0 CM	150	CRILE-WOOD NEEDLE-HOLDER TC 18.0 CM	134
CLAUS-EICKEN LIGATURE NEEDLE 23.0 CM	150	CUSCO VAG.SPEC.W.CENTR.RAT.95X37 MM	259
COAKLEY ANTRUM TROCAR 2.25 MM 14 CM	220	CUSCO VAG.SPECULUM SWISS PATT.100X25MM	259
COGSWELL, SUCTION TUBE, 23,0 CM, Ø 2,0	222	CUSCO VAG.SPECULUM SWISS PATT.110X27 MM	259
COHEN CONE LARGE, ONLY	269	CUSCO VAG.SPECULUM SWISS.PATT.	259
COHEN CONE SMALL, ONLY	269	CUSCO VAG.SPECULUM W.CENTR.RAT.75X32 MM	259
COHEN, INTRA-UTERINE PROBE,	269	CUSCO VAG.SPECULUM W.CENTR.RAT.85X36 MM	259
COLLIER NEEDLE HOLDER 12.5 CM	124	CUSCO VAGINAL SPECULUM 100X35 MM	259
COLLIN ABDOMINAL RETRACTOR 22.0 CM	199	CUSCO VAGINAL SPECULUM 75X32 MM	259
COLLIN ABDOMINAL RETRACTOR 22.0 CM	199	CUSCO VAGINAL SPECULUM 85X35 MM	259
COLLIN AMPUTATION KNIFE,	8	CUSCO VAGINAL SPECULUM VIRGIN S.75X17	259
COLLIN CLIP FORCEPS 13.0 CM	154	CUSCO, VAGINAL SPECULA, 105 x 25 MM	258
COLLIN DRESSING FORCEPS 24.0 CM	89	CUSCO, VAGINAL SPECULA, 107 x 29 MM	258
COLLIN SEIZING FCPS OVAL 16.0 CM	96	CUSCO, VAGINAL SPECULA, 115 x 35 MM	258
COLLIN VAG.SPECULUM 100 X 35 MM	258	CUSCO, VAGINAL SPECULA, 80 x 24 MM	258
COLLIN VAG.SPECULUM 110 X 40 MM	258	CUSCO, VAGINAL SPECULA, 80 x 32 MM	258
COLLIN VAG.SPECULUM 85 X 30 MM	258	CUSCO, VAGINAL SPECULA, 98 x 16 MM	258
COLLIN, ABDOMINAL RETRACTOR COMPL.	199	CUSHING DRESSING FORCEPS CVD 17.5 CM	67
COLLIN, ABDOMINAL RETRACTOR, VALVE	200	CUSHING DRESSING FORCEPS STR 17.5 CM	67
COLLIN, ABDOMINAL RETRACTOR, VALVE	200	CUSHING FCPS TC CVD 17.5 CM	83
COLLIN, ABDOMINAL RETRACTOR, VALVE	200	CUSHING FCPS TC STRAIGHT 17.5 CM	83
COLLIN, AMPUTATION KNIFE,	8	CUSHING RECTRACTOR 10 MM 20.0 CM	165
COLLIN, AMPUTATION KNIFE,	8	CUSHING RECTRACTOR 12 MM 20.0 CM	165
COLLIN, AMPUTATION KNIFE,	8	CUSHING RECTRACTOR 14 MM 20.0 CM	165
COLLIN, AMPUTATION KNIFE,	8	CUSHING RECTRACTOR 16 MM 20.0 CM	165
COLLIN, MALLETS	306	CUSHING RECTRACTOR 18 MM 20.0 CM	165
COLLIN, OPERATING KNIFE, HOLLOW HANDLE,	6	CUSHING RECTRACTOR 8 MM 20.0 CM	165
COLLIN, OPERATING KNIFE, HOLLOW HANDLE,	6	CUSHING RETRACTOR 10MM 24,0 CM	165
COLLIN, OPERATING KNIFE, HOLLOW HANDLE,	6	CUSHING RETRACTOR 12 MM 24.0 CM	165
COLLIN, OPERATING KNIFE, HOLLOW HANDLE,	6	CUSHING RETRACTOR 14 MM 24.0 CM	165
COLLIN, OPERATING KNIFE, HOLLOW HANDLE,	6	CUSHING RETRACTOR 16 MM 24.0 CM	165
COLLIN, OPERATING KNIFE, HOLLOW HANDLE,	6	CUSHING RETRACTOR 18 MM 24.0 CM	165
COLLIN, OPERATING KNIFE, HOLLOW HANDLE,	6	CUSHING RETRACTOR 8 MM 24.0 CM	165
COLLIN, UTERINE ELEVATING FORCEPS, 25 CM	277	CUSHING TISSUE FORCEPS CVD 1X2 T.17.5	74
COLLIN, UTERINE PROBE, Ø 4 MM, 28,0 CM	277	CUSHING TISSUE FORCEPS STR 1X2 T.	74
COLLIN, VAGINAL SPECULA F. CHILDREN,	258	CUSHING, NERVE HOOK, FIG. 1	161
COLLIN, VAGINAL SPECULA F. VIRGINS,	258	CUSHING, NERVE HOOK, FIG. 2	161
COLLIN-BABY ABDOMINAL RETRACTOR	198	CUSHING-TAYLOR FCPS.TC 18.0 CM	83
COLLIN-DUVAL GRASPING FCPS 20,0 CM/14	75	CYLINDER ONLY, INSULINE SYRINGE, LUER,	227
COLLIN-DUVAL GRASPING FCPS 20,0 CM/18	75	CYLINDER ONLY, INSULINE SYRINGE, LUER,	227
COLLIN-DUVAL GRASPING FCPS 20,0 CM/27	75	CYLINDER ONLY, JANET, WOUND A. BLADDER	228
CONNECTING PIECE, LUER-LOCK	229	CYLINDER ONLY, JANET, WOUND A. BLADDER	228
CONNECTING PIECE, LUER-LOCK	229	CYLINDER ONLY, JANET, WOUND A. BLADDER	228
CONNECTING PIECE, LUER-LOCK	229	CYLINDER ONLY, SYRINGE LUER, 1 ML	227
CONNECTING PIECE, LUER-LOCK,	229	CYLINDER ONLY, SYRINGE LUER, 10 ML	227
CONNECTING PIECE, LUER-LOCK,	229	CYLINDER ONLY, SYRINGE LUER, 2 ML	227
COOLEY SUCTION TUBE 30.0 CM, Ø 7,0 MM	222		

CYLINDER ONLY, SYRINGE LUER, 20 ML	227	DE BAKEY, VASCULAR SCISSORS TC	53
CYLINDER ONLY, SYRINGE LUER, 5 ML	227	DE BAKEY, VASCULAR SCISSORS TC	53
CYLINDER ONLY, SYRINGE LUER, 50 ML	227	DE BAKEY, VASCULAR SCISSORS TC 25°	53
CYLINDER ONLY, SYRINGE, LUER-LOCK, 1 ML	227	DE BAKEY, VASCULAR SCISSORS TC 45°	53
CYLINDER ONLY, SYRINGE, LUER-LOCK, 10	227	DE BAKEY, VASCULAR SCISSORS,	36
CYLINDER ONLY, SYRINGE, LUER-LOCK, 10	228	DE BAKEY, VASCULAR SCISSORS,	36
CYLINDER ONLY, SYRINGE, LUER-LOCK, 2 ML	227	DE BAKEY, VASCULAR SCISSORS,	36
CYLINDER ONLY, SYRINGE, LUER-LOCK, 20	228	DE BAKEY, VASCULAR SCISSORS,	36
CYLINDER ONLY, SYRINGE, LUER-LOCK, 20 ML	227	DE BAKEY, VASCULAR SCISSORS,	36
CYLINDER ONLY, SYRINGE, LUER-LOCK, 30	228	DE BAKEY, VASCULAR SCISSORS,	36
CYLINDER ONLY, SYRINGE, LUER-LOCK, 5 ML	227	DE BAKEY, VASCULAR SCISSORS,	36
CYLINDER ONLY, SYRINGE, LUER-LOCK, 50	228	DE BAKEY, VASCULAR SCISSORS,	36
CYLINDER ONLY, SYRINGE, LUER-LOCK, 50 ML	227	DE BAKEY, VASCULAR SCISSORS,	36
CYLINDER ONLY, TUBERCULINE SYRINGE,	228	DE BAKEY, VASCULAR SCISSORS,	36
CZERNY, GALL STONE FORCEPS, 24,5 CM	233	DE BAKEY, VASCULAR SCISSORS,	36
CZERNY, RETRACTOR, DOUBLE-ENDED, SOLID/	168	DE BAKEY, VASCULAR SCISSORS,	36
CZERNY, UTERINE TENACULUM FORCEPS, 4X4	275	DE BAKEY, VASCULAR SCISSORS,	36
DANDY NEUROSURGICAL SCISSORS 17.0 CM	34	DE BAKEY, VASCULAR SCISSORS,	36
DANDY ARTERY FCPS CVD 1X2 T. 14.0 CM	102	DE BAKEY, VASCULAR SCISSORS,	36
DARTIGUES UTER.ELEVATING FORCEPS 27.0	276	DE BAKEY, VASCULAR SCISSORS, TC	53
DAUBENSPECK, BONE CURETTE, FIG. 0 20 CM	299	DE BAKEY, VASCULAR SCISSORS, TC 60°	53
DAUBENSPECK, BONE CURETTE, FIG.1 20 CM	299	DE LA ROZA LIGATURE NEEDLE LEFT 12.0 CM	149
DAUBENSPECK, BONE CURETTE, FIG.2 20 CM	299	DE LA ROZA LIGATURE NEEDLE RIGHT 12.0	149
DAUBENSPECK, BONE CURETTE,FIG.00 20 CM	299	DE LEE, OBSTETRICAL FORCEPS, 30.0CM	289
DAVIDSON RETRACTOR 75X50 MM 16.0 CM	186	DE LEE, OBSTETRICAL FORCEPS, 36, 0 CM	289
DAVIDSON RETRACTOR 75X90 MM 16.0 CM	186	DE LEE, OBSTETRICAL FORCEPS, 38, 0 CM	289
DAVIDSON, TROCAR W. IRRIGATION TUBE, Ø	219	DE MARTEL-WOLFSON CLAMP CLOS.FCPS	249
DE BAKEY ARTERY SCISSORS 15.5 CM	38	DE MARTEL-WOLFSON CLAMP HOLDER 8,5 CM	249
DE BAKEY ARTERY SCISSORS 15.5 CM	38	DE MARTEL-WOLFSON COLON-ANASTOMOSIS	249
DE BAKEY ATRAUMA BULLD.CLAMP CVD 10.0	95	DE MARTEL-WOLFSON COLON-ANASTOMOSIS	249
DE BAKEY ATRAUMA BULLD.CLAMP CVD 11.5	95	DE MARTEL-WOLFSON COLON-ANASTOMOSIS	249
DE BAKEY ATRAUMA BULLDOG CLAMP	95	DEAVER RETRACTOR 25 MM 30 CM	186
DE BAKEY ATRAUMA BULLDOG CLAMP	95	DEAVER RETRACTOR 38 MM 30 CM	186
DE BAKEY ATRAUMA BULLDOG CLAMP	95	DEAVER RETRACTOR 50 MM 30 CM	186
DE BAKEY ATRAUMA BULLDOG CLAMP	95	DEAVER RETRACTOR 75 MM 30 CM	186
DE BAKEY ATRAUMA BULLDOG CLAMP CVD	95	DEAVER RETRACTOR WIDTH 19 MM 18.0 CM	184
DE BAKEY ATRAUMA BULLDOG CLAMP CVD	95	DEAVER RETRACTOR WIDTH 22 MM 21.5 CM	184
DE BAKEY ATRAUMA FCPS ANGLED 1.5 MM	81	DEAVER RETRACTOR WIDTH 25 MM 23.0 CM	184
DE BAKEY ATRAUMA FCPS ANGLED 1.5 MM	81	DEAVER RETRACTOR WIDTH 25 MM 30.0 CM	185
DE BAKEY ATRAUMA FCPS ANGLED 1.5 MM	81	DEAVER RETRACTOR WIDTH 25 MM 33.0 CM	185
DE BAKEY ATRAUMA FCPS CVD 2.0 MM 24.0	81	DEAVER RETRACTOR WIDTH 25 MM 36.0 CM	185
DE BAKEY ATRAUMA FCPS CVD 2.0 MM 30.0	81	DEAVER RETRACTOR WIDTH 38 MM 30.0 CM	185
DE BAKEY ATRAUMA FCPS CVD 2.0MM 16.0 CM	81	DEAVER RETRACTOR WIDTH 50 MM 30.0 CM	185
DE BAKEY ATRAUMA FCPS CVD 2.0MM 20.0 CM	81	DEAVER RETRACTOR WIDTH 75 MM 30.0 CM	185
DE BAKEY ATRAUMA FCPS STR 1.5 MM 24.0	81	DEAVER, SURG. SCISSOR CURVED	15
DE BAKEY ATRAUMA FCPS STR 1.5 MM 30,0	81	DEAVER, SURG. SCISSOR CURVED	15
DE BAKEY ATRAUMA FCPS STR 2,4MM 24.0 CM	81	DEAVER, SURG. SCISSOR STRAIGHT	15
DE BAKEY ATRAUMA FCPS STR 2,4MM 30.0 CM	81	DEAVER, SURG. SCISSOR, STRAIGHT	15
DE BAKEY ATRAUMA FCPS STR 2,8 MM 16.0	81	DEAVER, SURG. SCISSOR, STRAIGHT,	15
DE BAKEY ATRAUMA FCPS STR 2,8 MM 20.0	81	DEAVER, SURGICAL SCISSORS	16
DE BAKEY ATRAUMA FCPS STR 2,8 MM 24.0	81	DEAVER, SURGICAL SCISSORS,	15
DE BAKEY ATRAUMA FCPS STR 2,8 MM 30.0	81	DEAVER, SURGICAL SCISSORS,	16
DE BAKEY ATRAUMA FCPS STR 2,8 MM 24.0	81	DEAVER, SURGICAL SCISSORS,	16
DE BAKEY ATRAUMA FCPS STR 2,8 MM 30.0	81	DEAVER, SURGICAL SCISSORS,	16
DE BAKEY ATRAUMA FCPS STR 3.5 MM 16.0	81	DEAVER, SURGICAL SCISSORS,	16
DE BAKEY ATRAUMA FCPS STR 3.5 MM 16.0	81	DEAVER, SURGICAL SCISSORS,	16
DE BAKEY ATRAUMA FCPS STR 3.5 MM 20.0	81	DEAVER, SURGICAL SCISSORS,	16
DE BAKEY ATRAUMA FCPS STR 3.5 MM 20.0	81	DEAVER, SURGICAL SCISSORS,	16
DE BAKEY ATRAUMA FCPS STR 3.5 MM 24.0	81	DEAVER, SURGICAL SCISSORS,	16
DE BAKEY ATRAUMA FCPS STR 3.5 MM 24.0	81	DEAVER, SURGICAL SCISSORS,	16
DE BAKEY ATRAUMA FCPS STR 3.5 MM 30.0	81	DEAVER, SURGICAL SCISSORS,	16
DE BAKEY ATRAUMA FCPS STR 3.5 MM 30.0	81	DEAVER, SURGICAL SCISSORS,	16
DE BAKEY ATRAUMA FCPS.ANGLED 1,5 MM	81	DEBAKEY, SELF-RETAINING RETRACTOR, SHARP	195
DE BAKEY NEEDLE HOLDER TC 18.0 CM	136	DEBAKEY, SELF-RETAINING RETRACTOR,SHARP	195
DE BAKEY NEEDLE HOLDER TC 20.0 CM	136	DELICATE HOOK 1 PRONG BLUNT 16.0 CM	161
DE BAKEY NEEDLE HOLDER TC 23.0 CM	136	DELICATE HOOK 1 PRONG SHARP 16.0 CM	161
DE BAKEY NEEDLE HOLDER TC 26.0 CM	136	DELICATE HOOK 2 PRONGS BLUNT 16.0 CM	161
DE BAKEY NEEDLE HOLDER TC 31.0 CM	136	DELICATE HOOK 2-PRONGS SHARP 16.0 CM	161
DE BAKEY NEEDLE HOLDER TC 37.0 CM	136	DELICATE HOOK 3 PRONGS BLUNT 16.0 CM	161
DE BAKEY, SUCTION TUBE, 27,0 CM	222	DELICATE HOOK 3 PRONGS SHARP 16.0 CM	161
DE BAKEY, VASCULAR FORCEPS, ATRAUMATIC	81	DELICATE HOOK 4 PRONGS BLUNT 16.0 CM	161
DE BAKEY, VASCULAR FORCEPS, ATRAUMATIC	81	DELICATE HOOK 4 PRONGS SHARP 16.0 CM	161
DE BAKEY, VASCULAR FORCEPS, ATRAUMATIC	81	DELICATE HOOK FIG.1 16.0 CM	159
DE BAKEY, VASCULAR FORCEPS, ATRAUMATIC	81	DELICATE HOOK FIG.2 16.0 CM	159
DE BAKEY, VASCULAR FORCEPS, ATRAUMATIC	81	DELICATE HOOK FIG.3 16.0 CM	159
DE BAKEY, VASCULAR FORCEPS, ATRAUMATIC	81	DELICATE HOOK FIG.4 16.0 CM	159
DE BAKEY, VASCULAR FORCEPS, ATRAUMATIC	81	DENNIS-BROWN, DRESSING FORCEPS, 20.0 CM	68
DE BAKEY, VASCULAR FORCEPS, ATRAUMATIC	81	DENNIS-BROWNE, ABDOMINAL RETRACTOR,	205
DE BAKEY, VASCULAR FORCEPS, ATRAUMATIC	81	DENNIS-BROWNE, ABDOMINAL RETRACTOR,	205
DE BAKEY, VASCULAR FORCEPS, ATRAUMATIC	81	DENNIS-BROWNE, ABDOMINAL RETRACTOR,	205

Alphabetisches Inhaltsverzeichnis
Alphabetical Index

DENNIS-BROWNE, ABDOMINAL RETRACTOR,	205	DISPOSABLE SCALPELS, STERILE, FIG. 18,	5
DERF NEEDLE HOLDER 12.0 CM	124	DISPOSABLE SCALPELS, STERILE, FIG. 19,	5
DERF, NEEDLE HOLDER, WITH TC, 12,0 CM	133	DISPOSABLE SCALPELS, STERILE, FIG. 20,	5
DERF-CONVERSE NEEDLE HOLDER 12.5 CM	124	DISPOSABLE SCALPELS, STERILE, FIG. 21,	5
DESCHAMPS NEEDLE LEFT BLUNT 21 CM	147	DISPOSABLE SCALPELS, STERILE, FIG. 22,	5
DESCHAMPS NEEDLE LEFT BLUNT 27 CM	147	DISPOSABLE SCALPELS, STERILE, FIG. 23,	5
DESCHAMPS NEEDLE LEFT BLUNT MEDIUM 20	146	DISPOSABLE SCALPELS, STERILE, FIG. 24,	5
DESCHAMPS NEEDLE LEFT BLUNT SMALL	146	DISPOSABLE SCALPELS, STERILE, FIG. 25,	5
DESCHAMPS NEEDLE LEFT RIGHT WIDE 21.0	147	DISSECTING OPERATION KNIFE FIG.10	7
DESCHAMPS NEEDLE LEFT SHARP MEDIUM 20	146	DISSECTING OPERATION KNIFE FIG.2 17,0 cm	7
DESCHAMPS NEEDLE LEFT SHARP WIDE 21.0	147	DISSECTING OPERATION KNIFE FIG.3	7
DESCHAMPS NEEDLE LEFT SHARP WIDE 27.0	147	DISSECTING OPERATION KNIFE FIG.4	7
DESCHAMPS NEEDLE RIGHT BLUNT MED 20.0	146	DISSECTING OPERATION KNIFE FIG.5	7
DESCHAMPS NEEDLE RIGHT BLUNT SMALL 20	146	DISSECTING OPERATION KNIFE FIG.6	7
DESCHAMPS NEEDLE RIGHT BLUNT WIDE 21.0	147	DISSECTING OPERATION KNIFE FIG.7	7
DESCHAMPS NEEDLE RIGHT BLUNT WIDE 27.0	147	DISSECTING OPERATION KNIFE FIG.8	7
DESCHAMPS NEEDLE RIGHT SHARP MED 20.0	146	DISSECTING OPERATION KNIFE FIG.9	7
DESCHAMPS NEEDLE RIGHT SHARP WIDE	147	DISSECTING, OPERATION KNIFE FIG.1	7
DESCHAMPS, LIGATURE NEEDLE 20 CM	146	DISSECTION MICRO SCISSORS BL/BL 14.5 CM	60
DESCHAMPS, LIGATURE NEEDLE 20 CM	146	DISSECTION MICRO SCISSORS BL/BL 15.0 CM	60
DESJARDINS GALL DUCT CLAMP 21,0 CM	114	DISSECTION MICRO SCISSORS BL/BL 18.0 CM	60
DESJARDINS GALL STONE FCPS.23.0 CM	232	DISSECTION MICRO SCISSORS BL/BL,	60
DESJARDINS GALL STONE FCPS.23.0 CM	232	DIXON-LOVELACE ART.FORCEPS STR 15.5 CM	103
DESJARDINS, GALL STONE PROBE,	235	DIXON-LOVELACE STR.1X2 T 15.5 CM	103
DESJARDINS, GALL STONE PROBE,	235	DOUGALS TROCAR 11.0 CM 3.0 MM	221
DESJARDINS, GALL STONE PROBE,	235	DOYEN ABD.SCISSORS CVD BL/BL 16.0 CM	40
DESJARDINS, GALL STONE SCOOP,	235	DOYEN ABD.SCISSORS STR BL/BL 16.0 CM	40
DESJARDINS, GALL STONE SCOOP,	235	DOYEN ABD.SCISSORS STR SH/BL 16.0 CM	40
DESJARDINS, GALL STONE SCOOP,	235	DOYEN ABDOMINAL SCISSORS CURVED 17,5 CM	40
DESMARRES RETRACTOR 10 MM 16.0 CM	164	DOYEN ABDOMINAL SCISSORS STRAIGHT	40
DESMARRES RETRACTOR 12 MM 16.0 CM	164	DOYEN AT INTEST.CLAMP FCPS. CVD. 21,0	246
DESMARRES RETRACTOR 14 MM 16.0 CM	164	DOYEN AT INTEST.CLAMP FCPS. CVD. 23,0	246
DESMARRES RETRACTOR 16 MM 16.0 CM	164	DOYEN AT INTEST.CLAMP FCPS. STR. 23,0	246
DESMARRES RETRACTOR 18 MM 16.0	164	DOYEN AT INTEST.CLAMP FCPS. STR.21,0 CM	246
DESMARRES RETRACTOR 8 MM 16.0 CM	164	DOYEN INTESTINAL CLAMP FCPS CVD 21.0 CM	245
DESMARRES, RETRACTOR 10 MM 13 CM	164	DOYEN INTESTINAL CLAMP FCPS CVD 23.0 CM	245
DESMARRES, RETRACTOR 10 MM 13 CM	164	DOYEN INTESTINAL CLAMP FCPS STR 21.0 CM	245
DESMARRES, RETRACTOR 12 MM 13 CM	164	DOYEN INTESTINAL CLAMP FCPS STR 23.0 CM	245
DESMARRES, RETRACTOR 14 MM 13 CM	164	DOYEN MYOMA SCREW 17.0CM	279
DESMARRES, RETRACTOR 16 MM 13 CM	164	DOYEN MYOMA SCREW 19 CM	279
DESMARRES, RETRACTOR 18 mm 13 cm	164	DOYEN PERIOST.RASPATORY CVD LEFT 17.0	303
DESMARRES, RETRACTOR 8 MM 13 CM	164	DOYEN PERIOST.RASPATORY CVD LEFT 17.0CM	303
DIEFFENBACH BULLDOG CLAMPS CVD 3.5 CM	94	DOYEN PERIOST.RASPATORY CVD RIGHT	303
DIEFFENBACH BULLDOG CLAMPS CVD 5.0 CM	94	DOYEN PERIOT.RASPATORY CVD RIGHT HAND	303
DIEFFENBACH BULLDOG CLAMPS STR 3.5 CM	94	DOYEN PROBE 14.5 CM	214
DIEFFENBACH BULLDOG CLAMPS STR 5.0 CM	94	DOYEN RETRACTOR 105X65 MM 28.0 CM	209
DIEFFENBACH, OPERATION KNIFE,	7	DOYEN RETRACTOR 115X65 MM 28.0 CM	209
DIEFFENBACH, OPERATION KNIFE,	7	DOYEN RETRACTOR 125X65 MM 28.0 CM	209
DIEFFENBACH, OPERATION KNIFE,	7	DOYEN RETRACTOR 50X85 MM 25.0 CM	178
DIEFFENBACH, OPERATION KNIFE,	7	DOYEN RETRACTOR 95X60 MM 28.0 CM	209
DIEFFENBACH, OPERATION KNIFE,	7	DOYEN VAG.SPECULUM SL.CONCAVE 115X35 MM	264
DIEFFENBACH, OPERATION KNIFE,	7	DOYEN VAG.SPECULUM SL.CONCAVE 115X45 MM	264
DIEFFENBACH, OPERATION KNIFE,	7	DOYEN VAG.SPECULUM SL.CONCAVE 115X60 MM	264
DIEFFENBACH, OPERATION KNIFE,	7	DOYEN VAG.SPECULUM SL.CONCAVE 160X45 MM	264
DIEFFENBACH, OPERATION KNIFE,	7	DOYEN VAG.SPECULUM SL.CONCAVE 160X60 MM	264
DIEFFENBACH, OPERATION KNIFE,	7	DOYEN VAG.SPECULUM SL.CONCAVE 55X35 MM	264
DIEFFENBACH,OPERATION KNIFE,	7	DOYEN VAG.SPECULUM SL.CONCAVE 55X45 MM	264
DIETHRICH MICRO NEEDLE HOLDER TC 26.0CM	133	DOYEN VAG.SPECULUM SL.CONCAVE 55X60 MM	264
DIETHRICH MICRO-NEEDLE HOLDER TC 16.0CM	133	DOYEN VAG.SPECULUM SL.CONCAVE 85X35 MM	264
DIETHRICH MICRO-NEEDLE HOLDER TC 18.0CM	133	DOYEN VAG.SPECULUM SL.CONCAVE 85X45 MM	264
DIETHRICH MICRO-NEEDLE HOLDER TC 20.0CM	133	DOYEN VAG.SPECULUM SL.CONCAVE 85X60 MM	264
DIETHRICH MICRO-NEEDLE HOLDER TC 23.0CM	133	DOYEN, POLYPUS AND OVUM FORCEPS, 20,5 CM	276
DIETHRICH, VASCULAR SCS. TC, 125°, 17.5	53	DOYEN, VAGINAL SPECULA, 60X30 MM 23 CM	268
DIETHRICH-HEGEMANN, VASCULAR SCS. TC,	54	DOYEN, VAGINAL SPECULA, 80X30 MM 25 CM	268
DIETHRICH-HEGEMANN, VASCULAR SCS. TC,	54	DOYEN, VAGINAL SPECULA, MEDIUM CONCAVE,	264
DIETHRICH-HEGEMANN, VASCULAR SCS. TC,	54	DOYEN, VAGINAL SPECULA, MEDIUM CONCAVE,	264
DIETHRICH-HEGEMANN, VASCULAR SCS. TC,	54	DOYEN, VAGINAL SPECULA, MEDIUM CONCAVE,	264
DIETHRICH-HEGEMANN, VASCULAR SCS. TC,	54	DOYEN, VAGINAL SPECULA, MEDIUM CONCAVE,	264
DIRECTOR (PROBE), GROOVED, WITH BUTTON,	215	DOYEN, VAGINAL SPECULA, MEDIUM CONCAVE,	264
DIRECTOR (PROBE), GROOVED, WITH BUTTON,	215	DOYEN, VAGINAL SPECULA, MEDIUM CONCAVE,	264
DIRECTOR (PROBE), GROOVED, WITH BUTTON,	215	DOYEN, VAGINAL SPECULA, MEDIUM CONCAVE,	264
DIRECTOR (PROBE), GROOVED, WITH BUTTON,	215	DOYEN, VAGINAL SPECULA, MEDIUM CONCAVE,	264
DISPOSABLE SCALPELS, STERILE, FIG. 10,	4	DOYEN, VAGINAL SPECULA, MEDIUM CONCAVE,	264
DISPOSABLE SCALPELS, STERILE, FIG. 11,	4	DOYEN-STILLE, RETRACTOR, 105x30 MM, 22CM	179
DISPOSABLE SCALPELS, STERILE, FIG. 11S,	4	DOYEN-STILLE, RETRACTOR, 120x52 MM,	179
DISPOSABLE SCALPELS, STERILE, FIG. 12,	4	DOYEN-STILLE, RETRACTOR.90x28 MM, 22CM	179
DISPOSABLE SCALPELS, STERILE, FIG. 12D,	4	DRESSING FCPS MOD.USA GRACILE 12.0 CM	65
DISPOSABLE SCALPELS, STERILE, FIG. 13,	4	DRESSING FCPS MOD.USA GRACILE 13.0 CM	65
DISPOSABLE SCALPELS, STERILE, FIG. 15,	4	DRESSING FCPS MOD.USA GRACILE 14.5 CM	65
DISPOSABLE SCALPELS, STERILE, FIG. 15C,	4	DRESSING FCPS MOD.USA GRACILE 15.5 CM	65

DRESSING FCPS MOD.USA GRACILE 18,0 CM	65	EMMET FISTULA HOOK FIG.2 22,0 CM	279
DRESSING FCPS MOD.USA GRACILE 20,0 CM	65	EMMET FISTULA HOOK FIG.3 22,0 CM	279
DRESSING FCPS MOD.USA GRACILE 25,0 CM	65	EMMET FISTULA HOOK FIG.4 22,0 CM	279
DRESSING FCPS., STANDARD, TC, 14,5 CM	82	EMMET FISTULA HOOK FIG.5 22,0 CM	279
DRESSING FCPS., STANDARD, TC, 16,0 CM	82	ENDARTERECTOMY, DISSEC.-SCS., SC, CRV	56
DRESSING FCPS., STANDARD, TC, 18,0 CM	82	ENGL.MODEL TOWEL FORCEPS 9,0 CM	86
DRESSING FCPS., STANDARD, TC, 20,0 CM	82	ENTEROTOMY SCS FOR ANATOMY 21,0 CM	41
DRESSING FCPS., STANDARD, TC, 25,0 CM	82	ENTEROTOMY SCS. FOR ANATOMY 21,0 CM	41
DRESSING FCPS., STANDARD, TC, 30,0 CM	82	ENTEROTOMY SCS. FOR ANATOMY 21,0 CM	41
DRESSING FORCEPS FINE 10,5CM	64	EPISIOTOMY-SCISSORS 20,0 CM	43
DRESSING FORCEPS FINE 11,5CM	64	EPPENDORF CERV.BIOPSY+SPEC.FCPS 20,0 CM	287
DRESSING FORCEPS FINE 13,0CM	64	ESMARCH BANDAGE SCISSORS 20,0 CM	45
DRESSING FORCEPS FINE 14,5CM	64	ESMARCH BANDAGE SCISSORS 22,0 CM	45
DRESSING FORCEPS FINE 15,0CM	64	EXCHANGEABLE BLADE 100X70 MM	203
DRESSING FORCEPS FINE 16,0CM	64	EXCHANGEABLE BLADE 38X62 MM	200
DRESSING FORCEPS FINE 18,0CM	64	EXCHANGEABLE BLADE 40X80 MM	200
DRESSING FORCEPS FINE 20,0CM	64	EXCHANGEABLE BLADE 50X58 MM	200
DRESSING FORCEPS FINE 25,0CM	64	EXCHANGEABLE BLADE 60X80 MM	200
DRESSING FORCEPS FINE 30,0CM	64	EXCHANGEABLE BLADE 60X80 MM	200
DRESSING FORCEPS MOD.USA 10,0 CM	65	EXCHANGEABLE BLADE 60X80 MM	200
DRESSING FORCEPS MOD.USA 13,0 CM	65	EXCHANGEABLE BLADE 60X80 MM	200
DRESSING FORCEPS MOD.USA 14,5 CM	65	EXCHANGEABLE BLADE 72X85 MM	200
DRESSING FORCEPS MOD.USA 15,5 CM	65	FALK LIGATURE NEEDLE LEFT 24,0 CM	150
DRESSING FORCEPS MOD.USA 18,0 CM	65	FALK LIGATURE NEEDLE RIGHT 24,0 CM	150
DRESSING FORCEPS MOD.USA 21,0 CM	65	FANSLER, ANOSCOPE, Ø 25 X 65 MM	254
DRESSING FORCEPS MOD.USA 25,0 CM	65	FANSLER, ANOSCOPE, Ø 29 X 65 MM	254
DRESSING FORCEPS MOD.USA 31,0 CM	65	FANSLER, ANOSCOPE, Ø 38 X 70 MM	254
DRESSING FORCEPS NARROW 10,5 CM STR.	64	FARABEUF PERIOSTEAL RASPARTORY CVD	303
DRESSING FORCEPS NARROW 11,5 CM	64	FARABEUF PERIOSTEAL RASPARTORY STR 12,5MM	302
DRESSING FORCEPS NARROW 13,0 CM	64	FARABEUF RETRACTOR SET FIG.1+2 12,0	167
DRESSING FORCEPS NARROW 14,5 CM	64	FARABEUF, RETRACTOR	167
DRESSING FORCEPS NARROW 15 CM	64	FARREL COTTON APPL.0,9 MM 12,0 CM ROUND	216
DRESSING FORCEPS NARROW 16,0 CM	64	FARREL COTTON APPL.0,9 MM 14,0 CM ROUND	216
DRESSING FORCEPS NARROW 18,0 CM	64	FARREL COTTON APPL.1,1 MM 16,5 CM ROUND	216
DRESSING FORCEPS NARROW 20,0 CM	64	FARREL COTTON APPL.1,2 MM 18,0 CM ROUND	216
DRESSING FORCEPS NARROW 25,0 CM	64	FARREL COTTON APPL.TRIANGLE SERR.0,9 MM	216
DRESSING FORCEPS NARROW 30,0 CM	64	FARREL COTTON APPL.TRIANGLE SERR.0,9 MM	216
DRESSING FORCEPS NARROW CVD 10,5 CM	64	FARREL COTTON APPL.TRIANGLE SERR.1,2 MM	216
DRESSING FORCEPS NARROW CVD 11,5 CM	64	FARREL COTTON APPL.TRIANGLE SERR.1,1 MM	216
DRESSING FORCEPS NARROW CVD 13,0 CM	64	FAURE PERIT.CLAMP-FCPS 1X2 T. 20,0 CM	119
DRESSING FORCEPS NARROW CVD 14,5 CM	64	FAURE PERIT.CLAMP-FCPS 1X2 T. 20,0 CM	119
DRESSING FORCEPS NARROW CVD 15,0 CM	64	FAURE, CERVICAL BIOPSY+SPEC FCPS 21 CM	287
DRESSING FORCEPS NARROW CVD 16,0 CM	64	FAVALORO ARTERY SCISSORS 15,0 CM	38
DRESSING FORCEPS NARROW CVD 18,0 CM	64	FEILCHENFELD SPLINTER FORCEPS 11,5 CM	78
DRESSING FORCEPS NARROW CVD 20,0 CM	64	FEILCHENFELD SPLINTER FORCEPS 7,5 CM	78
DRESSING FORCEPS NARROW CVD 25,0 CM	64	FEILCHENFELD SPLINTER FORCEPS 9,0 CM	78
DRESSING FORCEPS NARROW CVD 30,0 CM	64	FEIN COTTON APPLICATOR 28,0 CM	216
DRESSING FORCEPS, ENGL. PATTERN, 13,0	67	FERGUSSON OPERATING SCISSORS 16,5 CM	32
DRESSING FORCEPS, ENGL. PATTERN, 14,5	67	FERGUSSON OPERATING SCISSORS 18,0 CM	32
DRESSING FORCEPS, ENGL. PATTERN, 15,0	67	FERGUSSON ANGIOTRIBE CVD.16,0 CM	98
DRESSING FORCEPS, FINE, CURVED, 11,5CM	65	FERGUSSON ANGIOTRIBE CVD.20,0 CM	98
DRESSING FORCEPS, FINE, CURVED, 13 CM	65	FERGUSSON ANGIOTRIBE STR.16,0 CM	98
DRESSING FORCEPS, FINE, CURVED, 13,0CM	65	FERGUSSON ANGIOTRIBE STR.20,0 CM	98
DRESSING FORCEPS, FINE, CURVED, 14,5CM	65	FERGUSSON, GALL STONE SCOOPS,	234
DRESSING FORCEPS, FINE, CURVED, 16,0CM	65	FERGUSSON, SUCTION TUBE CHARR. 10 18 CM	223
DRESSING FORCEPS, FINE, CURVED, 18,0CM	65	FERGUSSON, SUCTION TUBE CHARR. 12 18 CM	223
DRESSING FORCEPS, FINE, CURVED, 20,0CM	65	FERGUSSON, SUCTION TUBE CHARR. 6 18 CM	223
DRESSING FORCEPS, FINE, CURVED, 25,0CM	65	FERGUSSON, SUCTION TUBE CHARR. 8	223
DRESSING FORCEPS, FINE, CURVED, 30,0CM	65	FIBRE OPTIC LIGHT CARRIER FOR ALAN	253
DUBOIS CEPHALOTOMY SCS CVD BL/BL 27,0	41	FINE OPER.SCISSORS CVD SH/SH 11,0 CM	29
DUBOIS CEPHALOTOMY SCS STR BL/BL 27,0	41	FINE OPER.SCISSORS STR SH/SH 11,0 CM	29
DUEHRSSSEN TISSUE FCPS 1X2 TEETH 20,0 CM	75	FINE OPER.SCISSORS STR SH/SH 11,5 CM	29
DUEHRSSSEN TISSUE FCPS 2X3 TEETH 20,0 CM	75	FINE OPERATING SCISSORS	29
DUEHRSSSEN TISSUE FCPS 3X4 TEETH 20,0 CM	75	FINE OPERATING SCISSORS	30
DUEHRSSSEN, DRESSING FCPS., 20 CM	68	FINE OPERATING SCISSORS,	30
DUPLAY, UTERINE TENACULUM FORCEPS, 28 CM	273	FINGER NAIL DRILL, DRILL ONLY	294
DURANTE TISSUE FCPS 16,0 CM	75	FINGER NAIL DRILL, DRILL ONLY	294
DURANTE TISSUE FORCEPS 14,5 CM	75	FINGER NAIL DRILL, DRILL ONLY	294
DURANTE TISSUE FORCEPS 20,0 CM	75	FINGER NAIL DRILL, WITH 3 DRILL POINTS	294
DUVAL INT.TISSUE FCPS LARGE 20,0 CM	245	FINGER RING SAW, BOX-LOCK 17 CM	296
DUVAL INT.TISSUE FCPS LARGE 23,0 CM	245	FINOCCHIETTO ARTERY FORCEPS 24,0 CM	115
DUVAL INT.TISSUE FCPS SMALL 20,0 CM	245	FINOCCHIETTO NEEDLE HOLDER ANGLED	127
DUVAL INT.TISSUE FORCEPS SMALL 18,0 CM	245	FINOCCHIETTO NEEDLE HOLDER TC 27,0 CM	138
DUVAL INTEST.CLAMP FCPS. TC 20,0 CM	244	FINOCCHIETTO RIB SPREADER 40X40X165	211
DUVAL, INTESTINAL FORCEPS, FIG.1, 14,0	75	FINOCCHIETTO RIB SPREADER 65X70X200	211
DUVAL, INTESTINAL FORCEPS, FIG.2, 14,0	75	FINOCCHIETTO RIB SPREADER 70X65X250	211
EISELSBERG LIGATURE SCISSORS 11,0 CM	34	FINOCCHIETTO-BABY RIB SPREADER 18X20/75	211
ELLIOT, OBSTETREICAL FORCEPS, 32,0 CM	290	FINOCHIETTO LOBECT SCS CVD BL 27,0 CM	42
ELLIOT, OBSTETREICAL FORCEPS, 38,0 CM	290	FINSIN RETRACTOR BL 2X3 PRONGS 5,0 CM	188
EMMET FISTULA HOOK FIG.1 22,0 CM	279	FINSIN RETRACTOR BL 3X4 PRONGS 7,0 CM	188

Alphabetisches Inhaltsverzeichnis
Alphabetical Index

FINSEN RETRACTOR SH 2X3 PRONGS 5.0 CM	188	GIL-VERNET RETRACTOR 13 MM 24.5 CM	166
FINSEN RETRACTOR SH 3X4 PRONGS 7.0 CM	188	GIL-VERNET RETRACTOR 17 MM 24.0 CM	166
FISTULA HOOK, 25,0 CM	279	GIL-VERNET RETRACTOR 17 MM 24.5 CM	166
FOERSTER SPONGE HOLDING NARROW CVD	90	GIL-VERNET RETRACTOR 9 MM 24.0 CM	166
FOERSTER SPONGE HOLDING NARROW STR	90	GIL-VERNET RETRACTOR 9 MM 24.5 CM	166
FOERSTER-BALLENGER CVD SERRATED 18.0 CM	90	GIL-VERNET, RETRACTOR, 20 MM, 24,5 CM	166
FOERSTER-BALLENGER CVD SERRATED 25.0 CM	90	GIL-VERNET, RETRACTOR, 20 MM, 24.0 CM	166
FOERSTER-BALLENGER CVD SMOOTH 18.0 CM	90	GIL-VERNET, RETRACTOR, 23 MM, 24,5 CM	166
FOERSTER-BALLENGER CVD SMOOTH 25.0 CM	90	GIL-VERNET, RETRACTOR, 23 MM, 24.0 CM	166
FOERSTER-BALLENGER FCPS CURVED 20,0 CM	90	GLASSMAN, INTESTINAL CLAMP FORCEPS, 60°	248
FOERSTER-BALLENGER FCPS CVD.SERR.20,0	90	GLASSMAN, INTESTINAL CLAMP FORCEPS, 90°	248
FOERSTER-BALLENGER FCPS STRAIGHT 20,0	90	GLOVER ATRAUMA-BULLDOG CLAMP	96
FOERSTER-BALLENGER FCPS.STR.SERR.20,0	90	GLOVER ATRAUMA-BULLDOG CLAMP	96
FOERSTER-BALLENGER STR SERRATED 18.0 CM	90	GLOVER ATRAUMA-BULLDOG CLAMP	96
FOERSTER-BALLENGER STR SERRATED 25.0 CM	90	GLOVER ATRAUMA-BULLDOG CLAMP CVD	96
FOERSTER-BALLENGER STR SMOOTH 18.0 CM	90	GLOVER ATRAUMA-BULLDOG CLAMP CVD 8.5	96
FOERSTER-BALLENGER STR SMOOTH 25.0 CM	90	GLOVER ATRAUMA-BULLDOG CLAMP STR	96
FOMON NASAL SCISSORS BLUNT 13,5 CM	19	GOELET RETRACTOR 19.0 CM	169
FOMON NASAL SCISSORS BLUNT 13,5 CM	33	GOMEL, MICRO-NEEDLE HOLDER, CURVED,	130
FOMON, NASAL SCS., SC, BL/BL, 14,5 CM	58	GOMEL, MICRO-SCS., ROUND-HANDLE,	59
FORCEPS CHIR. STR., TC 1X2 T 14CM	82	GOMEL, MICRO-SCS., ROUND-HANDLE,	59
FORCEPS CHIR. STR., TC 1X2 T 16 CM	82	GOOD TONSIL SCISSORS CVD 19.0 CM	36
FORCEPS CHIR. STR., TC 1X2 T 18 CM	82	GOSSET ABDOMINAL RETRACTOR 100MM	201
FORCEPS CHIR. STR., TC 1X2 T 20 CM	82	GOSSET ABDOMINAL RETRACTOR 140MM	201
FORCEPS CHIR. STR., TC 1X2 T 25 CM	82	GOSSET ABDOMINAL RETRACTOR 160MM	201
FORCEPS CHIR. STR., TC 1X2 T 30 CM	82	GOUGE, 10MM 13,5CM	304
FORCEPS FINE PATTERN STR 10.5 CM	65	GOUGE, 12MM 13,5CM	304
FORCEPS FINE PATTERN STR 11.5 CM	65	GOUGE, 14MM 13,5CM	304
FORCEPS FINE PATTERN STR 13.0 CM	65	GOUGE, 16MM 13,5CM	304
FORCEPS FINE PATTERN STR 14.5 CM	65	GOUGE, 8MM 13,5CM	304
FORCEPS FINE PATTERN STR 16.0 CM	65	GRAEFE DELICATE HOOK BLUNT 16,0 CM	158
FORCEPS FINE PATTERN STR 18.0 CM	65	GRAEFE DELICATE HOOK SHARP 16,0 CM	158
FORCEPS FINE PATTERN STR 20.0 CM	65	GRAEFE FORCEPS STR 1X2 TEETH 10 CM	79
FORCEPS FINE PATTERN STR 25.0 CM	65	GRAEFE FORCEPS STR SERR. 10.0 CM	79
FORCEPS FINE PATTERN STR 30.0 CM	65	GRAEFE IRIS FCPS STRO.CVD 1X2 T. 10.0	79
FOX, LUPUS CURETTE, Ø 3 MM, 14,0 CM	295	GRAEFE IRIS FORCEPS SL.CVD 1X2 T.	79
FOX, LUPUS CURETTE, Ø 4 MM, 14,0 CM	295	GRAEFE IRIS FORCEPS SL.CVD SERR. 10.0	79
FOX, LUPUS CURETTE, Ø 5 MM, 14,0 CM	295	GRAEFE IRIS FORCEPS STRO.CVD SERR	79
FOX, LUPUS CURETTE, Ø 6 MM, 14,0 CM	295	GRAVE VAG.SPECULUM 115 X 35 MM	260
FRANZ, ABDOMINAL RETRACTOR, COMPLETE	208	GRAVE VAG.SPECULUM 75 X 20 MM	260
FRANZ, ABDOMINAL RETRACTOR, FRAME ONLY,	208	GRAVE VAG.SPECULUM 95 X 35 MM	260
FRANZ, ABDOMINAL RETRACTOR, VALVE ONLY,	208	GRAY GALL DUCT CLAMP ,S' 1X2 T 22.0 CM	115
FRANZ, ABDOMINAL RETRACTOR, VALVE ONLY,	208	GRAY GALL DUCT CLAMP ,S' 1X2 T. 23.0 CM	115
FRANZ, ABDOMINAL RETRACTOR, VALVE ONLY,	208	GRAY GALL DUCT CLAMP S-SHAPED 22.0 CM	115
FRANZ, ABDOMINAL RETRACTOR, VALVE ONLY,	208	GRAY GALL DUCT CLAMP S-SHAPED 23.0 CM	115
FRAZIER BRAIN SUCTION TUBE CHARR 6/17CM	223	GREEN-ARMYTAGE, CAESAREAN SECTION	291
FRAZIER BRAIN SUCTION TUBE CHARR10/17CM	223	GROOVED DIRECTOR 11.5 CM 3,5 MM	215
FRAZIER SUCTION TUBE CHARR 12/ 17,0CM	223	GROOVED DIRECTOR 13.0 CM 3,5 MM	215
FRAZIER SUCTION TUBE CHARR 8/17CM	223	GROOVED DIRECTOR 14.5 CM 3,5 MM	215
FRAZIER, DURA AND SKIN RETRACTOR,	158	GROOVED DIRECTOR 16.0 CM 3,5 MM	215
FRITSCH RETRACTOR 45X40 MM 24.0 CM	178	GROOVED DIRECTOR 18.0 CM 3,5 MM	215
FRITSCH RETRACTOR 45X50 MM 24.0 CM	178	GROOVED DIRECTOR 20.0 CM 3,5 MM	215
FRITSCH RETRACTOR 45X60 MM 24.0 CM	178	GROSS-MAIER DRESSING FCPS CURVED 20,0	90
FRITSCH RETRACTOR 55X75 MM 24.0 CM	178	GROSS-MAIER DRESSING FCPS CURVED 22,0	90
FRITSCH RETRACTOR 65X85 MM 24.0 CM	178	GROSS-MAIER DRESSING FCPS CURVED 25,0	90
GARLAND CLAMP FORCEPS 21.0 CM	121	GROSS-MAIER DRESSING FCPS CURVED 27,0	90
GELPI RETRACTOR 14.0 CM	193	GROSS-MAIER DRESSING FCPS STR 20,0 CM	90
GELPI RETRACTOR 19.0 CM	193	GROSS-MAIER DRESSING FCPS STR 22,0 CM	90
GELPI-LOKTITE, RETRACTOR, 18,0 CM	193	GROSS-MAIER DRESSING FCPS STR 25,0 CM	90
GEMINI, DISSECTING AND LIGATURE FCPS,	112	GROSS-MAIER DRESSING FCPS STR 27,0 CM	90
GEMINI, DISSECTING AND LIGATURE FCPS,	112	GUTHRIE DELICATE HOOK FIG.1 16.0 CM	159
GEMINI, DISSECTING AND LIGATURE FCPS,	112	GUTHRIE DELICATE HOOK FIG.2 16.0 CM	159
GEMINI, DISSECTING AND LIGATURE FCPS,	112	GUYON KIDNEY PED.CLAMP FCPS.23.0 CM	116
GEMINI, DISSECTING AND LIGATURE FCPS,	112	GUYON KIDNEY PEDICLE CLAMP FCPS 20.0 CM	116
GEMINI, DISSECTING AND LIGATURE FCPS,	112	GUYON KIDNEY PEDICLE CLAMP FCPS 22.0 CM	116
GEMINI, DISSECTING AND LIGATURE FCPS,	112	GUYON KIDNEY PEDICLE CLAMP FCPS 24.0 CM	116
GERALD DRESSING FORCEPS CVD 18.0 CM	67	GUYON, ATRAUMATIC GALL DUCT AND KIDNEY	116
GERALD TISSUE FORCEPS CVD 1X2 T. 17.0	73	GUYON, ATRAUMATIC GALL DUCT AND KIDNEY	116
GERALD TISSUE FORCEPS STR 1X2 T 17.0 CM	73	HABERER, ABDOMINAL SPATULA, 280 x 25/30	210
GERALD, DRESSING FCPS, TC, 17.0 CM	83	HABERER, ABDOMINAL SPATULA, 280 x 40/50	210
GERALD, DRESSING FORCEPS STRAIGHT	66	HABERER, ABDOMINAL SPATULA, 300 x 37/45	210
GERALD, TISSUE FORCEPS, 1X2 TEETH, TC,	83	HALLE NASAL SCISSORS CURVED 19.0 CM	33
GILLIES NEEDLE HOLDER/SCS TC 16.0 CM	140	HALLE, BONE CURETTE	299
GILLIES TISSUE FCPS 1X2 TEETH 15.0 CM	72	HALLE, BONE CURETTE	299
GILLIES TISSUE FORCEPS 1X2 T.TC 15.0 CM	83	HALLE, BONE CURETTE,	299
GILLIES, DURA AND SKIN HOOK, FIG. 1	158	HALSEY NEEDLE HOLDER 13.0 CM	124
GILLIES, DURA AND SKIN HOOK, FIG. 2	158	HALSEY NEEDLE HOLDER SMOOTH JAWS 13.0	124
GIL-VERNET RETRACTOR 11 MM 24.0 CM	166	HALSEY NEEDLE HOLDER TC 13.0 CM	134
GIL-VERNET RETRACTOR 11 MM 24.5 CM	166	HALSEY NEEDLE HOLDER TC SMOOTH 13.0CM	134
GIL-VERNET RETRACTOR 13 MM 24.0 CM	166	HALSTED ARTERY FCPS.CVD 18.0 CM	100

HALSTED ARTERY FCPS.CVD 1X2 18.0 CM	100	HEGAR UT.DILATOR W.SLOPED HDL.6.5 MM	270
HALSTED ARTERY FCPS.CVD 1X2 21.0 CM	100	HEGAR UT.DILATOR W.SLOPED HDL.7.5 MM	270
HALSTED ARTERY FCPS.CVD 21.0 CM	100	HEGAR UT.DILATOR W.SLOPED HDL.8.5 MM	270
HALSTED ARTERY FCPS.STR 18.0 CM	100	HEGAR UT.DILATOR W.SLOPED HDL.9.5 MM	270
HALSTED ARTERY FCPS.STR 1X2 18.0 CM	100	HEGAR UTERINE DILATORS 1.0/2.0MM 20 CM	271
HALSTED ARTERY FCPS.STR 1X2 21.0 CM	100	HEGAR UTERINE DILATORS 11.0/12.0MM 20 CM	271
HALSTED ARTERY FCPS.STR 21.0 CM	100	HEGAR UTERINE DILATORS 13.0/14.0MM 20 CM	271
HALSTED-MOSQUITO ART.FCPS CVD 14,0 CM	100	HEGAR UTERINE DILATORS 15.0/16.0MM 20 CM	271
HALSTED-MOSQUITO ART.FCPS STR 14,0 CM	100	HEGAR UTERINE DILATORS 17.0/18.0MM 20 CM	271
HALSTED-MOSQUITO ART.FCPS.1X2 CVD	100	HEGAR UTERINE DILATORS 19.0/20.0MM 20 CM	271
HALSTED-MOSQUITO ART.FCPS.1X2 STR	100	HEGAR UTERINE DILATORS 21.0/22.0MM 20 CM	271
HALSTED-MOSQUITO FCPS.1X2 CVD 12.5CM	100	HEGAR UTERINE DILATORS 23.0/24.0MM 20 CM	271
HALSTED-MOSQUITO FCPS.1X2 STR 14.0CM	100	HEGAR UTERINE DILATORS 25.0/26.0MM 20 CM	271
HALSTED-MOSQUITO, ARTERY FORCEPS	100	HEGAR UTERINE DILATORS 3.0/4.0MM 20 CM	271
HALSTED-MOSQUITO, ARTERY FORCEPS	100	HEGAR UTERINE DILATORS 5.0/6.0MM 20 CM	271
HANDBRUSH, STERILIZABLE 134°	311	HEGAR UTERINE DILATORS 7.0/8.0MM	271
HANK SET OF 6 DILATORS 4.5/5-9.5/10MM	271	HEGAR UTERINE DILATORS 9.0/10.0MM 20 CM	271
HANK UTERINE DILATOR FIG.19/20,9.5/10MM	271	HEGAR, NEEDLE HOLDER WITH TC, 20,0 CM	139
HANK UTERINE DILATORS FIG.11/12,5.5/6MM	271	HEGAR, NEEDLE HOLDER WITH TC, 24,0 CM	139
HANK UTERINE DILATORS FIG.13/14,6.5/7MM	271	HEGAR, UTERINE-DILATOR, SET OF 13 PCS.,	271
HANK UTERINE DILATORS FIG.15/16,7.5/8MM	271	HEGAR, UTERINE-DILATOR, SET OF 8 PCS.,	271
HANK UTERINE DILATORS FIG.17/18,8.5/9MM	271	HEGAR-BAUMGARTNER, NEEDLE HOLDER, WITH	133
HANK UTERINE DILATORS FIG.9/10,4.5/5MM	271	HEGAR-BAUMGARTNER, NEEDLE HOLDER, WITH	133
HARRINGTON RETRACTOR 127X40 MM 32.0 CM	182	HEGAR-BAUMGARTNER, NEEDLE HOLDER,14,0CM	124
HARRINGTON RETRACTOR 127X62 MM 32.0 CM	182	HEGEMANN-DIETHRICH VASC.SCS	38
HARTMANN FORCEPS STR 10.0 CM	99	HEGEMANN-DIETHRICH, VASCULAR SCISSORS,	37
HARTMANN, ARTERY FORCEPS	99	HEGEMANN-DIETHRICH, VASCULAR SCISSORS,	37
HAYES, SIGMOID ANASTOMOSIS FORCEPS,	251	HEGEMANN-DIETHRICH, VASCULAR SCISSORS,	37
HAYES, SIGMOID ANASTOMOSIS FORCEPS,	251	HEGEMANN-DIETHRICH, VASCULAR SCISSORS,	37
HEANEY CLAMP-FORCEPS 1 TOOTH 21.0 CM	122	HEGEMANN-DIETHRICH, VASCULAR SCISSORS,	37
HEANEY CLAMP-FORCEPS 1 TOOTH 23.0 CM	122	HEGENBARTH SUTURE FORCEPS 12.5 CM	154
HEANEY CLAMP-FORCEPS 2 TEETH 21.5 CM	122	HEISS ARTERY FORCEPS STR. 20.0 CM FIG.1	107
HEANEY CLAMP-FORCEPS 2 TEETH 23.0 CM	122	HEISS ARTERY FORCEPS STRONG CURVE	107
HEANEY CLAMP-FORCEPS LIGHT JAWS 21.0 CM	121	HEISS FORCEPS SLIGHTLY CVD 20.0CM	107
HEANEY NEEDLE HOLDER CVD 21.0 CM	127	HENLEY EXCHANGEABLE BLADE 16X19 MM	197
HEANEY-BALLANTINE CLAMP FCPS.CVD 21.0	121	HENLEY EXCHANGEABLE BLADE 16X25 MM	197
HEANEY-BALLANTINE CLAMP FCPS.STR 21.0	121	HENLEY EXCHANGEABLE BLADES 32X16 MM	197
HEANEY-KANTER CLAMP FCPS. 2 TEETH21.0	121	HENLEY RETRACTOR SET	197
HEATH LIGATURE SCISSORS 15.0 CM	34	HENLEY RETRACTOR SET BLUNT 16 CM	197
HEGAR DILATORS, SET, Ø 1-26 MM, W.	270	HENLEY, SELF-RETAINING RETRACTOR, ONLY	197
HEGAR DILATORS, SET, Ø 4-17 MM, W.	270	HENLEY, SELF-RETAINING RETRACTOR, ONLY	197
HEGAR UT DILATOR W.SLOPED HDL 7.0 MM	270	HEPP SCHEIDEL, MICRO-NEEDLE HOLDER WITH	144
HEGAR UT.DILATOR W.SLOPED HDL 1.0 MM	270	HEPP/SCHIEDEL, SUCTION TUBE, W.	223
HEGAR UT.DILATOR W.SLOPED HDL 11.0 MM	270	HEPP-SCHIEDEL, MICRO-SCS.,	59
HEGAR UT.DILATOR W.SLOPED HDL 2.0 MM	270	HEPP-SCHIEDEL, MICRO-SCS.,	59
HEGAR UT.DILATOR W.SLOPED HDL 3.0 MM	270	HERRICK KIDNEY PEDICLE CLAMP FCPS	117
HEGAR UT.DILATOR W.SLOPED HDL 4.0 MM	270	HESS BULLDOG CLAMPS, 2,0 cm	94
HEGAR UT.DILATOR W.SLOPED HDL 5.0 MM	270	HESS, BULLDOG CLAMPS, 3,0 cm	94
HEGAR UT.DILATOR W.SLOPED HDL 6.0 MM	270	HESSBERG LIGATURE NEEDLE 15.0 CM	149
HEGAR UT.DILATOR W.SLOPED HDL 8.0 MM	270	HEYMANN NASAL SCISSORS BLUNT 18.0 CM	35
HEGAR UT.DILATOR W.SLOPED HDL 9.0 MM	270	HEYWOOD-SMITH, HAEMORRHOIDAL FORCEPS	276
HEGAR UT.DILATOR W.SLOPED HDL. 1.5 MM	270	HIRSCHMANN ANOSCOPE W.OBTURATOR 19X65	253
HEGAR UT.DILATOR W.SLOPED HDL.10.0 MM	270	HIRSCHMANN ANOSCOPE W.OBTURATOR 22X65	253
HEGAR UT.DILATOR W.SLOPED HDL.10.5 MM	270	HIRSCHMANN ANOSCOPE W.OBTURATOR 16X65	253
HEGAR UT.DILATOR W.SLOPED HDL.11.5 MM	270	HIRSCHMANN, ANOSCOPE W. OBTURATOR, Ø 22	253
HEGAR UT.DILATOR W.SLOPED HDL.12.0 MM	270	HOSEMANN, ARTERY FORCEPS, 1X2 TEETH,	114
HEGAR UT.DILATOR W.SLOPED HDL.12.5 MM	270	HOSEMANN, ARTERY FORCEPS, STRAIGHT,	114
HEGAR UT.DILATOR W.SLOPED HDL.13.0 MM	270	HUMBY, DERMATOMES, 35,0 CM	11
HEGAR UT.DILATOR W.SLOPED HDL.13.5 MM	270	HUMBY, DERMATOMES, SPARE BLADE	11
HEGAR UT.DILATOR W.SLOPED HDL.14.0 MM	270	HUNTER SPLINTER FORCEPS CVD 10.5 CM	78
HEGAR UT.DILATOR W.SLOPED HDL.14.5 MM	270	HUNTER SPLINTER FORCEPS STR 10.5 CM	78
HEGAR UT.DILATOR W.SLOPED HDL.15.0 MM	270	HURD LIGATURE NEEDLE LEFT 21.0 CM	150
HEGAR UT.DILATOR W.SLOPED HDL.15.5 MM	270	HURD LIGATURE NEEDLE RIGHT 21.0 CM	150
HEGAR UT.DILATOR W.SLOPED HDL.16.0 MM	270	HURWITZ, TROCAR, Ø 12 MM	218
HEGAR UT.DILATOR W.SLOPED HDL.16.5 MM	270	HURWITZ, TROCAR, Ø 7,3 MM	218
HEGAR UT.DILATOR W.SLOPED HDL.17,0 MM	270	HURWITZ, TROCAR, Ø 8,7 MM	218
HEGAR UT.DILATOR W.SLOPED HDL.17.5 MM	270	HYSTEREKTOMY, DISSEC.-SCS. TC,	51
HEGAR UT.DILATOR W.SLOPED HDL.18,0 MM	270	HYSTEREKTOMY, DISSEC.-SCS. TC,	51
HEGAR UT.DILATOR W.SLOPED HDL.19,0 MM	270	INCISION SCISSORS 13,0 CM	32
HEGAR UT.DILATOR W.SLOPED HDL.2.5 MM	270	INCISION SCISSORS 14,5 CM	32
HEGAR UT.DILATOR W.SLOPED HDL.20 MM	270	INCISION SCISSORS 15,5 CM	32
HEGAR UT.DILATOR W.SLOPED HDL.21 MM	270	INSTRUMENT BOXES, LID WITH KNOB,	310
HEGAR UT.DILATOR W.SLOPED HDL.22 MM	270	INSTRUMENT BOXES, LID WITH KNOB,	310
HEGAR UT.DILATOR W.SLOPED HDL.23 MM	270	INSTRUMENT BOXES, LID WITH KNOB,	310
HEGAR UT.DILATOR W.SLOPED HDL.24 MM	270	INSTRUMENT BOXES, LID WITH KNOB,	310
HEGAR UT.DILATOR W.SLOPED HDL.25 MM	270	INSTRUMENT BOXES, LID WITH KNOB,	310
HEGAR UT.DILATOR W.SLOPED HDL.26 MM	270	INSTRUMENT BOXES, LID WITH KNOB,	310
HEGAR UT.DILATOR W.SLOPED HDL.3.5 MM	270	INSTRUMENT BOXES, LID WITH KNOB,	310
HEGAR UT.DILATOR W.SLOPED HDL.4.5 MM	270	INSTRUMENT BOXES, LID WITH KNOB,	310
HEGAR UT.DILATOR W.SLOPED HDL.5.5 MM	270	INSTRUMENT BOXES, LID WITH KNOB,	310

Alphabetisches Inhaltsverzeichnis
Alphabetical Index

INSULINE SYRINGE, LUER, 1 ML	227	KALLMORGEN, VAGINAL RETRACTOR, FIG. 2,	265
INSULINE SYRINGE, LUER, 2 ML	227	KALLMORGEN, VAGINAL SPECULA, 17,0 CM,	265
IOWA TENACULUM FCPS.F.AMNION BLADDER 26	275	KALLMORGEN, VAGINAL SPECULA, FIG. 1,	265
IOWA, SUCTION TUBE, 14,0 CM	224	KALLMORGEN, VAGINAL SPECULA, FIG. 1,	265
IRIS SCISSOR CVD. SH/SH 11,5 CM SC	57	KALLMORGEN, VAGINAL SPECULA, FIG. 2,	265
IRIS SCISSOR STR. SH/SH 11,5 CM SC	57	KALLMORGEN, VAGINAL SPECULA, FIG. 2, 90	265
IRIS SCISSORS ANGLED SH/SH 11,5 CM	29	KALT MICRO-NEEDLE HOLDER TC 14,0 CM	133
IRIS SCISSORS CVD SH/SH 10,5 CM	28	KANTROWITZ DISS.AND LIG.FCPS. CVD	112
IRIS SCISSORS CVD SH/SH 11,5 CM	28	KANTROWITZ DISS.AND LIG.FCPS. CVD	112
IRIS SCISSORS CVD SH/SH 9,0 CM	28	KANTROWITZ DISS.AND LIG.FCPS. CVD	112
IRIS SCISSORS LATERALLY CVD SH/SH	29	KAYE FACE LIFT, DISSEC.-SCS., SC CRV.	56
IRIS SCISSORS STR SH/SH 10,5 CM	28	KAYE FACE LIFT, DISSEC.-SCS., SC CRV.	56
IRIS SCISSORS STR SH/SH 11,5 CM	28	KELLY FISTULA SCISSORS CURVED 16,0 CM	41
IRIS SCISSORS STR SH/SH 9,0 CM	28	KELLY FISTULA SCISSORS CURVED 18,0 CM	41
IRIS, FINE SCISSORS, CRV, TC 11,5 CM	55	KELLY FISTULA SCISSORS STRAIGHT 16,0 CM	40
IRIS, SCISSORS, TC ST POINTED 11,5 cm	55	KELLY FISTULA SCISSORS STRAIGHT 18,0 CM	40
ISRAEL RETR. 4 PRONGS 40X40 MM 25,0 CM	173	KELLY FORCEPS CURVED 14,0 CM	101
ISRAEL RETR. 6 PRONGS 50X60 MM 25,0 CM	173	KELLY FORCEPS STRAIGHT 14,0 CM	101
ISRAEL RETR. 6 PRONGS 70X70MM 25,0 CM	173	KELLY POLYPUS FORCEPS 32,0 CM	276
ISRAEL RETR.5 PRONGS 45X50 MM 25,0 CM	173	KELLY PROCTOSCOPE W.OBTURATOR 22X145 MM	253
IVES FANSLER, ANOSCOPE, Ø 22 MM	254	KELLY PROCTOSCOPE W.OBTURATOR 22X200 MM	253
IVES FANSLER, ANOSCOPE, W. COLD LIGHT	254	KELLY PROCTOSCOPE W.OBTURATOR 22X50 MM	253
JABALEY, FINE OP.-SCS., SC STRAIGHT	56	KELLY PROCTOSCOPE W.OBTURATOR 22X50 MM	253
JACKSON BURROWS, SELF-RETAINING	196	KELLY PROCTOSCOPE W.OBTURATOR 27X50 MM	253
JACKSON, VAGINAL SPECULA, FIG. 1, 75 x	265	KELLY PROCTOSCOPE W.OBTURATOR 22X100 MM	253
JACKSON, VAGINAL SPECULA, FIG. 2, 90 x	265	KELLY RETRACTOR 160X38 MM 27,0 CM	180
JACKSON, VAGINAL SPECULA, FIG. 3, 100 x	265	KELLY RETRACTOR 160X57 MM 27,0 CM	180
JACOBI LIGATURE NEEDLE 14,0 CM	149	KELLY RETRACTOR 190X38 MM 27,0 CM	180
JACOBS TENAC.FCPS SIDEW.CVD 2X2T.	274	KELLY RETRACTOR 190X57 MM 27,0 CM	180
JACOBS, UTERINE TENACULUM FORCEPS	274	KELLY, DISSECTING AND LIGATURE FCPS.,	111
JAMISON, DISSEC.-SCS., SC, ST, BL/BL	57	KELLY, DISSECTING AND LIGATURE FCPS.,	111
JAMISON, DISSEC.-SCS., SC, ST, BL/BL 15	57	KELLY, DISSECTING AND LIGATURE FCPS.,	111
JAMISON, NEEDLE HOLDER, 23,5 CM	127	KELLY, DISSECTING AND LIGATURE FCPS.,	111
JANET, WOUND A. BLADDER SYRINGE, 100 ML	228	KELLY, DISSECTING AND LIGATURE FCPS.,	111
JANET, WOUND A. BLADDER SYRINGE, 150 ML	228	KELLY, DISSECTING AND LIGATURE FCPS.,	111
JANET, WOUND A. BLADDER SYRINGE, 200 ML	228	KELLY, DISSECTING AND LIGATURE FCPS.,	111
JANET, WOUND A. BLADDER SYRINGE, 50 ML	228	KELLY, DISSECTING AND LIGATURE FCPS.,	111
JANSEN BONE CURETTES CURVED 15,0 CM	300	KELLY, DISSECTING AND LIGATURE FCPS.,	111
JANSEN BONE CURETTES STRAIGHT 16,0 CM	300	KELLY-RANKIN ARTERY FORCEPS CVD 16,0 CM	101
JANSEN RETRACTOR BLUNT 3X3 PRONGS 10 CM	188	KELLY-RANKIN, HAEMOSTATIC FORCEPS	101
JANSEN RETRACTOR SHARP 3X3 PROMGS	188	KEVORKIAN, BIOPSY CURETTE 30,0CM	278
JAR, Ø 100 x 175 MM	309	KEVORKIAN, BIOPSY CURETTE, 30,0 CM	278
JAR, Ø 100 x 200 MM	309	KEVORKIAN, BIOPSY CURETTE, 30,0 CM	278
JAR, Ø 75 x 130 MM	309	KEVORKIAN, BIOPSY FORCEPS;	287
JAR, Ø 75 x 175 MM	309	KEVORKIAN-PACIFIC CERVICAL BIOPSY FCPS	288
JARCHO, UTERINE TENACULUM FORCEPS,	273	KEYES, DERMAL PUNCH, Ø 2 MM, 12,0 CM	294
JEWELER'S FORCEPS NO.3 12,0 CM	80	KEYES, DERMAL PUNCH, Ø 3 MM, 12,0 CM	294
JEWELER'S FORCEPS NO.4 11,0 CM	80	KEYES, DERMAL PUNCH, Ø 4 MM, 12,0 CM	294
JEWELER'S FORCEPS NO.5 11,0 CM	80	KEYES, DERMAL PUNCH, Ø 5 MM, 12,0 CM	294
JEWELER'S FORCEPS NO.7 11,0 CM	80	KEYES, DERMAL PUNCH, Ø 6 MM, 12,0 CM	294
JOBSON-HORNE COTTON APPLICATOR 18,0 CM	216	KEYES, DERMAL PUNCH, Ø 7 MM, 12,0 CM	294
JOHNS HOPKINS BULLDOG CLAMP STR 9,0 CM	94	KEYES, DERMAL PUNCH, Ø 8 MM, 12,0 CM	294
JOHNS HOPKINS BULLDOG CLAMPS STR 4,0 CM	94	KEYES, DERMAL PUNCHES, SET, W. 6	294
JOHNS-HOPKINS ARTERY FCPS CVD 20,0 CM	108	KIDNEY TRAY, 250 MM	309
JOHNS-HOPKINS BULLDOG CLAMP CVD 4,0 CM	94	KIDNEY TRAY, 170 MM	309
JOHNS-HOPKINS BULLDOG CLAMP CVD 5,0 CM	94	KIDNEY TRAY, 275 MM	309
JOHNS-HOPKINS BULLDOG CLAMP CVD 6,5 CM	94	KIELLAND, OBSTETRECIAL FORCEPS, 41,0 CM	290
JOHNS-HOPKINS BULLDOG CLAMP CVD 7,5 CM	94	KIELLAND-LUIKART, OBSTETRICAL FORCEPS,	290
JOHNS-HOPKINS BULLDOG CLAMP CVD 9,0 CM	94	KILNER PLASTIC SURGERY SCS CVD 15,0 CM	26
JOHNS-HOPKINS BULLDOG CLAMP STR 5,0 CM	94	KILNER PLASTIC SURGERY SCS CVD 18,0 CM	26
JOHNS-HOPKINS BULLDOG CLAMP STR 6,5 CM	94	KILNER PLASTIC SURGERY SCS CVD 20,0 CM	26
JOHNS-HOPKINS BULLDOG CLAMP STR 7,5 CM	94	KILNER PLASTIC SURGERY SCS STR 12,0 CM	26
JOHNSON, NEEDLE HOLDER, 27,0 CM	127	KILNER PLASTIC SURGERY SCS STR 15,0 CM	26
JOLL (FRIEDMAN), VAGINAL-SELF-RETAINING	196	KILNER PLASTIC SURGERY SCS STR 18,0 CM	26
JONES TOWEL FORCEPS 5,0 CM	86	KILNER PLASTIC SURGERY SCS STR 20,0 CM	26
JONES TOWEL FORCEPS 7,0 CM	86	KILNER, PLASTIC SURGERY SCS CVD 12,0 CM	26
JONES TOWEL FORCEPS 9,0 CM	86	KILNER, SKIN HOOK, SHARP, 15 CM	158
JONES, TOWEL FORCEPS, WITH TUBE HOLDER,	86	KIRSCHNER ABDOMINAL RETRACTOR COMPLETE	206
JOSEPH DELICATE HOOK 1 MM 16,0 CM	159	KIRSCHNER LIGATURE CONDUCTOR 25,5 CM	153
JOSEPH DELICATE HOOK 16,0 CM	158	KIRSCHNER LIGATURE CONDUCTOR 28,0 CM	153
JOSEPH DELICATE HOOK 2 MM 16,0 CM	159	KIRSCHNER, ABDOMINAL RETRACTOR W.	206
JOSEPH DELICATE HOOK 3 MM 16,0 CM	159	KIRSCHNER, ABDOMINAL RETRACTOR W. OVAL	207
JOSEPH DELICATE HOOK 4 MM 16,0 CM	159	KIRSCHNER, ABDOMINAL RETRACTOR, FOLDING	206
JOSEPH PLASTIC SURGERY SCS CVD 14,0 CM	27	KIRSCHNER, ABDOMINAL RETRACTOR, FRAME	206
JOSEPH PLASTIC SURGERY SCS STR. 14,0 CM	27	KIRSCHNER, ABDOMINAL RETRACTOR, FRAME	206
JUDD-ALLIS INT.TISSUE FCPS 3X4 T.15.0	243	KIRSCHNER, ABDOMINAL RETRACTOR, FRAME	206
JUDD-ALLIS INT.TISSUE FCPS 3X4 T.19.0	243	KIRSCHNER, ABDOMINAL RETRACTOR, OVAL	207
JUDD-MASSON, BLADDER RETRACTOR	237	KIRSCHNER, ABDOMINAL RETRACTOR, VALVE	207
KAHN, UTERINE TENACULUM FORCEPS, 24,0	273	KIRSCHNER, ABDOMINAL RETRACTOR, VALVE	206
KALLMORGEN, VAGINAL RETRACTOR, FIG. 1,	265	KIRSCHNER, ABDOMINAL RETRACTOR, VALVE	206

KIRSCHNER, ABDOMINAL RETRACTOR, VALVE	206	KOGAN ENDOSPECULA 3MM, 24CM	269
KIRSCHNER, ABDOMINAL RETRACTOR, VALVE	206	KOGAN ENDOSPECULA 4MM, 24CM	269
KIRSCHNER, ABDOMINAL RETRACTOR, VALVE	206	KOGAN ENDOSPECULA 5MM, 24CM	269
KIRSCHNER, ABDOMINAL RETRACTOR, VALVE	207	KOGAN ENDOSPECULUM, 3 MM, W.RATCHET	269
KIRSCHNER, ABDOMINAL RETRACTOR, VALVE	207	KOGAN ENDOSPECULUM, 4 MM, W.RATCHET	269
KIRSCHNER-BALFOUR, ABDOMINAL RETRACTOR,	207	KOGAN ENDOSPECULUM, 5 MM, W.RATCHET	269
KIRSTEIN, TONSIL SCISSORS,	35	KÖNIG LIGATURE CONDUCTOR 3 MM 19,5 CM	152
KLEINERT-KUTZ DELICATE HOOK FIG.1	158	KÖNIG LIGATURE CONDUCTOR 5 MM 19,5 CM	152
KLEINERT-KUTZ DELICATE HOOK FIG.2	158	KÖNIG LIGATURE CONDUCTOR 7 MM 19,5 CM	152
KLEINERT-KUTZ DELICATE HOOK FIG.3	158	KÖNIG, RASPATORY, CURVED 5 MM 15,5 CM	302
KLIMA-ROSSEGER, STERNAL PUNCTURE CANNULA	225	KRAUSE TROCAR 16 CM 3.0 MM	221
KLINKENBERGH-LOTH ARTERY SCISSORS	39	KRAUSE TROCAR 16 CM 4 MM	221
Knapp wound retractor pointed 13cm	160	KRAUSE TROCAR 16 CM 5.0 MM	221
KNAPP, DELICATE HOOK,	160	KRAUSE TROCAR 16 CM 5.5 MM	221
KNOT TIERS 23.0 CM	154	KRISTELLER VAGINAL SPECULA SET FIG.0	263
KNOWLES SCISSORS FOR FINGERS STR 14.0	45	KRISTELLER VAGINAL SPECULA SET FIG.00	263
KOCHER AT INTEST.CLAMP FCPS. CVD.25,0	247	KRISTELLER VAGINAL SPECULA SET FIG.1	263
KOCHER AT INTEST.CLAMP FCPS. STR.22,0	247	KRISTELLER VAGINAL SPECULA SET FIG.2	263
KOCHER AT INTEST.CLAMP FCPS.CVD. 22,0	247	KRISTELLER VAGINAL SPECULA SET FIG.3	263
KOCHER AT INTEST.CLAMP FCPS.CVD. 28,0	247	KRISTELLER, VAGINAL RETRACTOR, FIG. 0,	263
KOCHER AT INTEST.CLAMP FCPS.STR. 25,0	247	KRISTELLER, VAGINAL RETRACTOR, FIG. 1,	263
KOCHER AT INTEST.CLAMP FCPS.STR. 28,0	247	KRISTELLER, VAGINAL RETRACTOR, FIG. 2,	263
KOCHER BLADDER RETRACTOR 90x61 mm 23,5cm	239	KRISTELLER, VAGINAL RETRACTOR, FIG. 3,	263
KOCHER INT. CLAMP FCPS.STR.ELAST.22,0	246	KRISTELLER, VAGINAL SPECULA,	262
KOCHER INT.CLAMP FCPS CVD ELASTIC	246	KRISTELLER, VAGINAL SPECULA,	262
KOCHER INT.CLAMP FCPS STR ELASTIC	246	KRISTELLER, VAGINAL SPECULA,	262
KOCHER INT.CLAMP FCPS. CVD.ELAST.22,0	246	KRISTELLER, VAGINAL SPECULA,	262
KOCHER INT.CLAMP FCPS. CVD.ELAST.28,0	246	KRISTELLER, VAGINAL SPECULA, 105X18MM,	263
KOCHER INT.CLAMP FCPS.STR. ELAST.28,0	246	KRISTELLER, VAGINAL SPECULA, 105X21MM,	263
KOCHER LIGATURE CONDUCTOR 15.0 CM	153	KRISTELLER, VAGINAL SPECULA, 105X26MM,	262
KOCHER LIGATURE CONDUCTOR 15.0 CM	153	KRISTELLER, VAGINAL SPECULA, 105X33MM,	262
KOCHER LIGATURE CONDUCTOR 16.0 CM	153	KRISTELLER, VAGINAL SPECULA, 110X14MM,	263
KOCHER LIGATURE CONDUCTOR 18.0 CM	153	KRISTELLER, VAGINAL SPECULA, 110X17MM,	263
KOCHER LIGATURE CONDUCTOR W/O EAR	153	KRISTELLER, VAGINAL SPECULA, 110X30MM,	262
KOCHER LIGATURE NEEDLE FIG.1 19.0 CM	148	KRISTELLER, VAGINAL SPECULA, 110X36MM,	262
KOCHER LIGATURE NEEDLE FIG.2 19.0 CM	148	KRISTELLER, VAGINAL SPECULA, 115X22MM,	262
KOCHER LIGATURE NEEDLE FIG.3 19.0 CM	148	KRISTELLER, VAGINAL SPECULA, 115X24MM,	262
KOCHER RETRACTOR 22 CM 1 PRONG	172	KRISTELLER, VAGINAL SPECULA, 115X26MM,	262
KOCHER RETRACTOR 22 CM 1 PRONG BLUNT	172	KRISTELLER, VAGINAL SPECULA, 115X32MM,	262
KOCHER RETRACTOR 22 CM 2 PRONGS	172	KRISTELLER, VAGINAL SPECULA, 70X27MM,	263
KOCHER RETRACTOR 22 CM 2 PRONGS BLUNT	172	KRISTELLER, VAGINAL SPECULA, 80X30MM,	263
KOCHER RETRACTOR 22 CM 3 PRONGS	172	KRISTELLER, VAGINAL SPECULA, 90X36MM,	263
KOCHER RETRACTOR 22 CM 3 PRONGS BLUNT	172	KRISTELLER, VAGINAL SPECULA, FIG. 0, 70	263
KOCHER RETRACTOR 22 CM 4 PRONGS	172	KRISTELLER, VAGINAL SPECULA, SET FIG.1	262
KOCHER RETRACTOR 22 CM 4 PRONGS BLUNT	172	KRISTELLER, VAGINAL SPECULA, SET FIG.1	262
KOCHER RETRACTOR 22 CM 4 PRONGS SHARP	171	KRISTELLER, VAGINAL SPECULA, SET FIG.2	262
KOCHER RETRACTOR 22 CM 6 PRONGS	172	KRISTELLER, VAGINAL SPECULA, SET FIG.2	262
KOCHER RETRACTOR 22 CM 6 PRONGS BLUNT	172	KRISTELLER, VAGINAL SPECULA, SET FIG.3	262
KOCHER RETRACTOR 22 CM 6 PRONGS SHARP	171	KRISTELLER, VAGINAL SPECULA, SET FIG.3	262
KOCHER RETRACTOR 22 CM 8 PRONGS	172	KRISTELLER, VAGINAL SPECULA, SET, FIG.0	263
KOCHER RETRACTOR 22 CM 8 PRONGS BLUNT	172	KRISTELLER, VAGINAL SPECULA, SET,17,0	265
KOCHER RETRACTOR 22 CM 8 PRONGS SHARP	171	KROENLEIN ARTERY FORCEPS STR 13.0 CM	98
KOCHER RETRACTOR 40X18 MM 23 CM	176	KRONECKER LIGATURE NEEDLE LEFT 15.0 CM	149
KOCHER RETRACTOR 60X20 MM 23.0 CM	176	KRONECKER LIGATURE NEEDLE RIGHT 15.0 CM	150
KOCHER RETRACTOR 60X25 MM 23.0 CM	176	LAHEY GALL DUCT CLAMP 19.0 CM	114
KOCHER RETRACTOR 70X25 MM 25 CM	179	LAHEY GALL DUCT CLAMP 23.0 CM	114
KOCHER RETRACTOR 75X30 MM 23.0 CM	176	LAHEY RETRACTOR 28X6 MM 19.0 CM	179
KOCHER RETRACTOR 75X40 MM 23.0 CM	176	LAMBOTTE RASPATORIES CURVED 15MM 21 CM	302
KOCHER RETRACTOR 80X42 MM 25.0 CM	179	LAMBOTTE RASPATORIES CURVED 20MM 21 CM	302
KOCHER RETRACTOR 80X50 MM 25.0 CM	179	LAMBOTTE RASPATORIES CURVED 25MM 21 CM	302
KOCHER RETRACTOR 80X60 MM 25.0 CM	179	LAMBOTTE, OSTEOTOME	306
KOCHER RETRACTOR SHARP 1 PRONG 22.0 CM	171	LAMBOTTE, OSTEOTOME	306
KOCHER RETRACTOR SHARP 2 PRONGS 22.0 CM	171	LAMBOTTE, OSTEOTOME	306
KOCHER RETRACTOR SHARP 3 PRONGS 22.0 CM	171	LAMBOTTE, OSTEOTOME	306
KOCHER-DELICATE ART.FCPS.CVD 1X2T 13 CM	105	LAMBOTTE, OSTEOTOME	306
KOCHER-DELICATE ART.FCPS.CVD 1X2T 14 CM	105	LAMBOTTE, OSTEOTOME	306
KOCHER-DELICATE ART.FCPS.STR 1X2T 13 CM	105	LAMBOTTE, OSTEOTOME	306
KOCHER-DELICATE ART.FCPS.STR 1X2T 14 CM	105	LAMBOTTE, OSTEOTOME	306
KOCHER-LANGENBECK RETRACTOR 25X6 MM	175	LAMBOTTE, OSTEOTOME	306
KOCHER-LANGENBECK RETRACTOR 35X11MM	175	LAMBOTTE, OSTEOTOME	306
KOCHER-LANGENBECK RETRACTOR 35X11MM	175	LAMBOTTE, OSTEOTOME	306
KOCHER-LANGENBECK RETRACTOR 35X8 MM	175	LAMBOTTE, OSTEOTOME	306
KOCHER-LANGENBECK RETRACTOR 40X11MM	175	LAMBOTTE, OSTEOTOME	306
KOCHER-LANGENBECK RETRACTOR 70X14MM	175	LAMBOTTE, OSTEOTOME CURVED 50 MM 24CM	306
KOCHER-LANGENBECK RETRACTOR 80X12MM	175	LAMBOTTE, OSTEOTOME, STRAIGHT 6 MM	306
KOCHER-LANGENBECK RETRACTOR 80X16 MM	175	LAMBOTTE, OSTEOTOME,CURVED 6 MM	306
KOCHER-LANGENBECK, RETRACTOR, 22X6 MM,	175	LAMBOTTE, RASPATORY CURVED	302
KOCHER-LANGENBECK, RETRACTOR, 25X8 MM,	175	LANDAU TROCAR 2.0 MM	219
KOERTE RETRACTOR 26X40 MM 24.0 CM	173	LANDAU, TROCAR, W. IRRIGATION TUBE, Ø	219
KOERTE RETRACTOR 26X40 MM 24.0 CM	173	LANDAU, VAGINAL SPECULA, BAYONET	267

Alphabetisches Inhaltsverzeichnis
Alphabetical Index

LANDAU, VAGINAL SPECULA, BAYONET	267	LISTER BANDAGE SCISSORS ANGLED 18.0 CM	44
LANDOLT FINE SCISSORS MORE CVD 12.5 CM	31	LISTER BANDAGE SCISSORS ANGLED 20.0 CM	44
LANDOLT FINE SCISSORS STRAIGHT 12.5 CM	31	LISTER BANDAGE SCISSORS ANGLED 9.0 CM	44
LANDOLT FINE SCISSORS STRONG CVD 12,5	31	LISTER BANDAGE SCISSORS TC 18.0 CM	55
LANE STOMACH CLAMP FCPS. CURVED 30,0 CM	250	LISTER SINUS FORCEPS 13.0 CM	88
LANE STOMACH CLAMP FCPS. STR. 30,0 CM	250	LISTER SINUS FORCEPS 16.0 CM	88
LANE TISSUE FORCEPS 1X2 TEETH 14.5 CM	76	LISTER SINUS FORCEPS 18.0 CM	88
LANE TISSUE FORCEPS 1X2 TEETH 20.0 CM	76	LISTER-EXCENTRIC SCS.SAW EDGE 16.0 CM	44
LANE TISSUE FORCEPS 2X3 TEETH 14.5 CM	76	LISTER-EXCENTRIC SCS.SAW EDGE 19.0 CM	44
LANE TISSUE FORCEPS 2X3 TEETH 20.0 CM	76	LISTON, AMPUTATION KNIFE,	8
LANE TOWEL FORCEPS 15.0 CM	87	LISTON, AMPUTATION KNIFE,	8
LANE TOWEL FORCEPS 18.0 CM	87	LISTON, AMPUTATION KNIFE,	8
LANE TOWEL FORCEPS 20,0 CM	87	LITTAUER, LIGATURE SCISSORS 11.5 CM	33
LANE, INTESTINAL AND TISSUE GRASPING	242	LITTAUER, LIGATURE SCISSORS 14.0 CM	33
LANE, INTESTINAL AND TISSUE GRASPING	242	LITTLE RETRACTOR 12X13 MM 20.0 CM	180
LANE, INTESTINAL AND TISSUE GRASPING	242	LITTLEWOOD INT.TISSUE FCPS 3X4 T.19.0	243
LANGE SUTURE FORCEPS 10.0 CM	155	LLOYD-DAVIES, LOBECTOMY SCS., CURVED,	41
LANGENBECK PERIOST.ELEVATOR 10 MM 20.0CM	301	LOADING ATTACHMENT FOR RUDD A. MC	255
LANGENBECK PERIOST.ELEVATOR 8 MM 20.0 CM	301	LOCKHART-MUMMERY PROBE FIG.1 16,5 CM	215
LANGENBECK PERIOSTEAL RASP.CVD. 19.0 CM	303	LOCKHART-MUMMERY PROBE FIG.2 16,5 CM	215
LANGENBECK RETR. 21.0 CM 30X11 MM GRID	174	LOCKHART-MUMMERY PROBE FIG.3 16,5 CM	215
LANGENBECK RETR. 22 CM 30X16 MM GRID	174	LOCKHART-MUMMERY PROBE FIG.4 16,5 CM	215
LANGENBECK RETR. 22 CM 40X11 MM GRID	174	LOCKWOOD INTESTINAL A. TISSUE	244
LANGENBECK RETR. 22 CM 50X11 MM GRID	174	LOCKWOOD-ALLIS, INTESTINAL A. TISSUE	242
LANGENBECK RETR. 22.0 CM 30X14 MM GRID	174	LOCKWOOD-ALLIS, INTESTINAL A. TISSUE	242
LANGENBECK RETRACTOR 22,0 CM 30X11 MM	174	LONG CLAMP FORCEPS CVD 1X2 T. 19.0 CM	121
LANGENBECK RETRACTOR 22,0 CM 30X14 MM	174	LORENZ BANDAGE SCISSORS CVD 23.0 CM	45
LANGENBECK RETRACTOR 22,0 CM 30X16 MM	174	LORNA TOWEL FORCEPS 10,0 CM	87
LANGENBECK RETRACTOR 22,0 CM 40X11 MM	174	LORNA TOWEL FORCEPS 13,0 CM	87
LANGENBECK RETRACTOR 22,0 CM 50X11 MM	174	LOVELACE LUNG GRASPING FCPS ST	117
LANGENBECK RETRACTOR 55X20 MM 21 CM	173	LOVELACE LUNG GRASPING FORCEPS 20CM	117
LANGENBECK RETRACTOR 60X20 MM 21.0 CM	173	LOWER ARTERY FCPS CVD 18.0 CM	114
LANGENBECK RETRACTOR 63X20 MM 21.0 CM	173	LUER-KOERTE, GALL STONE SCOOP	234
LANGENBECK, AMPUTATION KNIFE,	10	LUER-KOERTE, GALL STONE SCOOP	234
LANGENBECK, AMPUTATION KNIFE,	9	LUER-KOERTE, GALL STONE SCOOP	234
LANGENBECK, NEEDLE HOLDER TC 18.0 CM	143	LUER-KOERTE, GALL STONE SCOOP	234
LANGENBECK, NEEDLE HOLDER TC 20.0 CM	143	LUER-KOERTE, GALL STONE SCOOP,	234
LANGENBECK, NEEDLE HOLDER WITH TC 23.0	143	LUER-KOERTE, GALL STONE SCOOP,	234
LANGENBECK-GREEN, RETRACTOR, 16x6 MM,	161	LUER-KOERTE, GALL STONESCOOP	234
LANGENBECK-GREEN, RETRACTOR, 24x6 MM,	161	LUER-KOERTE, GALLSTONE SCOOP	234
LATERAL VAGINAL RETRACTOR 25,0 CM	269	LUER-LOCK, SPECIAL NEEDLE, 0,45 x 20 MM	224
LAWRENCE ARTERY FORCEPS CVD 28.0 CM	114	LUER-LOCK, SPECIAL NEEDLE, 0,50 x 23 MM	224
LAWRENCE, NEEDLE HOLDER, SMOOTH, 15,0	126	LUER-LOCK, SPECIAL NEEDLE, 0,60 x 25 MM	224
LAWSON TAIT CVD 12,5 CM	32	LUER-LOCK, SPECIAL NEEDLE, 0,65 x 28 MM	224
LEGUEU BLADDER RETRACTOR 90X35 MM 26 CM	239	LUER-LOCK, SPECIAL NEEDLE, 0,70 x 32 MM	224
LEGUEU, BLADDER RETRACTOR	237	LUER-LOCK, SPECIAL NEEDLE, 0,80 x 32 MM	224
LEMPERT, BONE CURETTE	299	LUER-LOCK, SPECIAL NEEDLE, 0,90 x 38 MM	224
LEMPERT, BONE CURETTE	299	M.G.H. NEEDLE HOLDER 17.0 CM	125
LEMPERT, BONE CURETTE	299	MAGILL, SUCTION TUBE W. FINGERRING, 2 MM	223
LEMPERT, BONE CURETTE	299	MAGILL, SUCTION TUBE W. FINGERRING, 3 MM	223
LEMPERT, BONE CURETTE	299	MAGILL, SUCTION TUBE W. FINGERRING, 4 MM	223
LEMPERT, BONE CURETTE	299	MAGILL, SUCTION TUBE W. FINGERRING, Ø1MM	223
LERICHE ARTERY FCPS CVD 1X2 T 15.0 CM	102	MAINGOT, HYSTERECTOMY FORCEPS, 1X2	120
LERICHE ARTERY FCPS STR 1X2 T 15.0 CM	102	MAINGOT, HYSTERECTOMY FORCEPS, 1X2	120
LERICHE ARTERY FORCEPS STR 15.0 CM	102	MARTEL FLAP FORCEPS 14.0 CM	97
LERICHE FORCEPS CVD 15.0 CM	102	MARTIN PELVIMETERS, CM/INCH-SCALE, 34.0CM	292
LERMOYEZ, TROCARS, Ø 2,0 MM	220	MARTIN UTERINE PROBES, 30.0CM	277
LERMOYEZ, TROCARS, Ø 2,5 MM	220	MARTIN, UTERINE PROBE, MALLEABLE, 32,0 M	277
LERMOYEZ, TROCARS, Ø 3,0 MM	220	MARTINI, BONE CURETTE,	300
LEXER SCISSORS TC CURVED 16.0 CM	47	MARTINI, BONE CURETTE,	300
LEXER SCISSORS TC CURVED 21.0 CM	47	MARTINI, BONE CURETTE,	300
LEXER SCISSORS TC STRAIGHT 16.0 CM	47	MASSON NEEDLE HOLDER 27.0 CM	127
LEXER SCISSORS TC STRAIGHT 21.0 CM	47	MASSON NEEDLE HOLDER TC 27.0 CM	138
LEXER, DISSEC.-SCS, CURVED, 16.0 CM	25	MATHIEU NEEDLE HOLDER 14.0 CM	129
LEXER, DISSEC.-SCS, CURVED, 21.0 CM	25	MATHIEU NEEDLE HOLDER 17.0 CM	129
LEXER, DISSEC.-SCS, STRAIGHT, 16.0 CM	25	MATHIEU NEEDLE HOLDER 20.0 CM	129
LEXER, DISSEC.-SCS, STRAIGHT, 21.0 CM	25	MATHIEU NEEDLE HOLDER SAFETY RAT.	129
LEXER-BABY, DISSECTING SCISSORS	25	MATHIEU NEEDLE HOLDER SAFETY RAT.	129
LEXER-BABY, DISSECTING SCISSORS,	25	MATHIEU NEEDLE HOLDER TC 14.0 CM	141
LICHTENBERG NEEDLE HOLDER 20.0 CM	129	MATHIEU NEEDLE HOLDER TC 17.0 CM	141
LICHTENBERG, NEEDLE HOLDER WITH TC,	142	MATHIEU NEEDLE HOLDER TC 20.0 CM	141
LICHTENBERG, NEEDLE HOLDER WITH TC,	142	MATHIEU RECTAL SPECULA 21 CM 90X15 MM	252
LICHTWITZ TROCAR 11.0 CM 1.6MM	221	MATHIEU RETRACTOR SET FIG.1+2 20 CM	168
LICHTWITZ TROCAR STRAIGHT 1.8 MM 20 CM	221	MATHIEU, FOREIGN BODY FORCEPS	238
LIGATURE NEEDLE FLEXIBLE 20.0 CM	147	MATHIEU, FOREIGN BODY FORCPES	238
LINCOLN VASCULAR SCISSORS CVD 17.0 CM	35	MATHIEU, NEEDLE HOLDER FINE 14.0 CM	129
LINCOLN VASCULAR SCISSORS STR 17.0 CM	35	MATHIEU, NEEDLE HOLDER FINE 17.0 CM	129
LISTER BANDAGE SCISSORS 1 L.RING 18.5	44	MATHIEU, NEEDLE HOLDER WITH TC, 17,0 CM	142
LISTER BANDAGE SCISSORS 1 L.RING 21.0	44	MATHIEU, NEEDLE HOLDER WITH TC, 20,0 CM	142
LISTER BANDAGE SCISSORS ANGLED 11.0 CM	44	MATHIEU, NEEDLE HOLDER WITH TC, 23,0 CM	142
LISTER BANDAGE SCISSORS ANGLED 14.0 CM	44		

MATHIEU, VAGINAL RETRACTOR, FIG. 1, 100	267	MAYO-ROBSON, INTESTINAL CLAMP FORCEPS,	248
MATHIEU, VAGINAL RETRACTOR, FIG. 2, 100	267	MAYO-STILLE OPER.SCS CVD BL/BL 15.0 CM	19
MATHIEU, VAGINAL SPECULA, FIG. 1, 100 x	267	MAYO-STILLE OPER.SCS CVD BL/BL 17.0 CM	19
MATHIEU, VAGINAL SPECULA, FIG. 2, 100 x	267	MAYO-STILLE OPER.SCS CVD BL/BL 19.5 CM	19
MATHIEU-KOCHER, NEEDLE HOLDER WITH TC,	141	MAYO-STILLE OPER.SCS CVD BL/BL 21.0 CM	19
MATHIEU-KOCHER, NEEDLE HOLDER WITH TC,	141	MAYO-STILLE OPER.SCS STR BL/BL 15.0 CM	19
MATHIEU-KOCHER, NEEDLE HOLDER WITH TC,	141	MAYO-STILLE OPER.SCS STR BL/BL 19.5 CM	19
MATHIEU-KOCHER, NEEDLE HOLDER, 14,0 CM	130	MAYO-STILLE OPER.SCS STR BL/BL 21.0 CM	19
MATHIEU-KOCHER, NEEDLE HOLDER, 17,0 CM	130	MAYO-STILLE SCS TC CVD BL/BL 15.0 CM	47
MATHIEU-KOCHER, NEEDLE HOLDER, 20,0 CM	130	MAYO-STILLE SCS TC CVD BL/BL 17.0 CM	47
MATZENAUER, VAGINAL SPECULA, 100X10 MM	268	MAYO-STILLE SCS TC STR BL/BL 15.0 CM	47
MATZENAUER, VAGINAL SPECULA, 100X20 MM	268	MAYO-STILLE SCS TC STR BL/BL 17.0 CM	47
MATZENAUER, VAGINAL SPECULA, 100X25 MM	268	MAYO-STILLE, OPERATING SCISSOR,	19
MATZENAUER, VAGINAL SPECULA, 125X15 MM	268	MC GIVNEY, HAEMORROIDAL GRASPING	256
MATZENAUER, VAGINAL SPECULA, 125X20 MM	268	MC GIVNEY, HAEMORROIDAL GRASPING	256
MATZENAUER, VAGINAL SPECULA, 125X25 MM	268	MC GIVNEY, HAEMORROIDAL W. LOADING	255
MATZENAUER, VAGINAL SPECULA, 125X30 MM	268	MC INDOE CARTILAGE SCISSORS 19.0 CM	39
MATZENAUER, VAGINAL SPECULA, 125X35 MM	268	MC INDOE DRESSING FORCEPS 15,0 CM	66
MATZENAUER, VAGINAL SPECULA, 125X40 MM	268	MC INDOE, DRESSING FCPS., TC. 15.0 CM	83
MATZENAUER, VAGINAL SPECULA, 90X20 MM	268	MC INDOE, TISSUE FCPS, 1X2 TEETH,	73
MAYO DISS.SCS TC CVD BL/BL 14.5 CM	47	MC LEAN, OBSTETRICAL FORCEPS, 36.0 CM	290
MAYO DISS.SCS TC CVD BL/BL 17.0 CM	47	MC QUIGG-MIXTER, DISSECTING AND	115
MAYO DISS.SCS TC CVD BL/BL 23.0 CM	47	MCDONALD ELEVATOR 19,0CM	301
MAYO DISS.SCS TC STR BL/BL 14.5 CM	47	MEEKER ARTERY FORCEPS CVD 18.0 CM	113
MAYO DISS.SCS TC STR BL/BL 17.0 CM	47	MEEKER ARTERY FORCEPS CVD 28.0 CM	113
MAYO DISS.SCS TC STR BL/BL 23.0 CM	47	MENGHINI, LIVER BLIND PUNCTURE NEEDLE,	226
MAYO OPER.SCS.CVD.BL/BL 17,0 CM SC	56	MENGHINI, LIVER BLIND PUNCTURE NEEDLE,	226
MAYO OPER.SCS.STR.BL/BL 17.0 CM SC	56	MENGHINI, LIVER BLIND PUNCTURE NEEDLE,	226
MAYO SAFETY PIN 14,0 CM	308	MENGHINI, LIVER BLIND PUNCTURE NEEDLE,	226
MAYO UTERINE SCISSORS STR BL/BL 28.0 CM	18	MENGHINI, LIVER BLIND PUNCTURE NEEDLE,	226
MAYO, GALL DUCT PROBE, 32,0 CM	235	MENGHINI, LIVER BLIND PUNCTURE NEEDLE,	226
MAYO, GALL STONE SCOOPS, DOUBLE-ENDED,	234	MENGHINI, LIVER BLIND PUNCTURE NEEDLE,	226
MAYO, GALL STONE SCOOPS, MALLEABLE,	234	MENGHINI, LIVER BLIND PUNCTURE NEEDLE,	226
MAYO, GALL STONE SCOOPS, MALLEABLE,	234	MENGHINI, LIVER BLIND PUNCTURE NEEDLE,	226
MAYO, OPER.SCS., CURVED, BL/BL, 14.5 CM	18	MENGHINI, LIVER BLIND PUNCTURE NEEDLE,	226
MAYO, OPER.SCS., CURVED, BL/BL, 17.0 CM	18	METAL CATHETER FOR MEN, 10 CH, 29,0 CM	240
MAYO, OPER.SCS., STRAIGHT, BL/BL, 14.5	18	METAL CATHETER FOR MEN, 12 CH, 29 CM	240
MAYO, OPER.SCS., STRAIGHT, BL/BL, 23.0	18	METAL CATHETER FOR MEN, 14 CH, 29 CM	240
MAYO, UTERINE SCISSORS, CVD., BL/BL	18	METAL CATHETER FOR MEN, 16 CH, 29 CM	240
MAYO, UTERINE SCISSORS, CVD., BL/BL	18	METAL CATHETER FOR MEN, 18 CH, 29 CM	240
MAYO-ADAMS, APPENDECTOMY RETRACTOR	198	METAL CATHETER FOR MEN, 20 CH, 29 CM	240
MAYO-ADAMS, APPENDECTOMY RETRACTOR	190	METAL CATHETER FOR MEN, 22 CH, 29,0	240
MAYO-BLAKE GALL STONE FCPS 20	232	METAL CATHETER FOR MEN, 24 CH, 29 CM	240
MAYO-BLAKE GALL STONE FCPS 20	232	METAL CATHETER FOR MEN, 8 CH, 29,0 CM	240
MAYO-HEGAR NEEDLE HOLDER 14.0 CM	126	METAL CATHETER FOR WOMEN, 10 CH, 16,0	240
MAYO-HEGAR NEEDLE HOLDER 16.0 CM	126	METAL CATHETER FOR WOMEN, 11 CH, 16,0	240
MAYO-HEGAR NEEDLE HOLDER 18.0 CM	126	METAL CATHETER FOR WOMEN, 12 CH, 16,0	240
MAYO-HEGAR NEEDLE HOLDER 20.0 CM	126	METAL CATHETER FOR WOMEN, 13 CH, 16,0	240
MAYO-HEGAR NEEDLE HOLDER 24.0 CM	126	METAL CATHETER FOR WOMEN, 14 CH, 16,0	240
MAYO-HEGAR NEEDLE HOLDER 26.0 CM	126	METAL CATHETER FOR WOMEN, 15 CH, 16,0	240
MAYO-HEGAR NEEDLE HOLDER 30.0 CM	126	METAL CATHETER FOR WOMEN, 16 CH, 16,0	240
MAYO-HEGAR NEEDLE HOLDER TC 16.0 CM	135	METAL CATHETER FOR WOMEN, 18 CH, 16,0	240
MAYO-HEGAR NEEDLE HOLDER TC 18.0 CM	135	METAL CATHETER FOR WOMEN, 20 CH, 16,0	240
MAYO-HEGAR NEEDLE HOLDER TC 20,0 CM	135	METAL CATHETER FOR WOMEN, 24 CH, 16,0	240
MAYO-HEGAR NEEDLE HOLDER TC 24.0 CM	135	METAL CATHETER FOR WOMEN, 6 CH, 16,0 CM	240
MAYO-HEGAR NEEDLE HOLDER TC 26.0 CM	135	METAL CATHETER FOR WOMEN, 7 CH, 16,0 CM	240
MAYO-HEGAR NEEDLE HOLDER TC 30.0 CM	135	METAL CATHETER FOR WOMEN, 8 CH, 16,0 CM	240
MAYO-HEGAR, NEEDLE HOLDER WITH TC,	138	METAL CATHETER FOR WOMEN, 9 CH, 16,0 CM	240
MAYO-HEGAR, NEEDLE HOLDER WITH TC, 18CM	138	METZENBAUM DELICATE BL/BL CVD 20.0 CM	23
MAYO-HEGAR, NEEDLE HOLDER WITH TC, 20,0	135	METZENBAUM SCISS TC CVD BL/BL 11.5 CM	48
MAYO-HEGAR, NEEDLE HOLDER WITH TC, 20CM	138	METZENBAUM SCISSOR CVD.BL/BL 14,0 CM SC	56
MAYO-HEGAR, NEEDLE HOLDER WITH TC, 24,0	135	METZENBAUM SCISSORS CVD 18CM SC BL/BL	56
MAYO-HEGAR, NEEDLE HOLDER WITH TC, 26,0	135	METZENBAUM SCISSORS CVD BL/BL 14.5 CM	20
MAYO-HEGAR, NEEDLE HOLDER WITH TC,23 CM	138	METZENBAUM SCISSORS CVD SH/BL 14.5 CM	20
MAYO-HEGAR-DELICATE NEEDLEH.16.0 CM	126	METZENBAUM SCISSORS CVD SH/SH 14.5 CM	20
MAYO-HEGAR-DELICATE NEEDLEH.18.0 CM	126	METZENBAUM SCISSORS STR BL/BL 14.5 CM	20
MAYO-HEGAR-DELICATE NEEDLEH.20.0 CM	126	METZENBAUM SCS CVD 20.0 CM SC	56
MAYO-NOBLE OPER.SCS CVD BL/BL 17.0 CM	19	METZENBAUM SCS TC CVD BL/BL 14.5 CM	48
MAYO-NOBLE OPER.SCS STR BL/BL 17.0 CM	19	METZENBAUM SCS TC CVD BL/BL 18.0 CM	48
MAYO-ROBSON INTEST.CLAMP FCPS	247	METZENBAUM SCS TC CVD BL/BL 20.0 CM	48
MAYO-ROBSON INTEST.CLAMP FCPS CVD	247	METZENBAUM SCS TC CVD BL/BL 23.0 CM	48
MAYO-ROBSON INTEST.CLAMP FCPS CVD	247	METZENBAUM SCS TC CVD BL/BL 25.0 CM	48
MAYO-ROBSON INTEST.CLAMP FCPS CVD	247	METZENBAUM SCS TC CVD BL/BL 28.0 CM	48
MAYO-ROBSON INTEST.CLAMP FCPS STR	247	METZENBAUM SCS TC CVD BL/BL 30.0 CM	48
MAYO-ROBSON INTEST.CLAMP FCPS STR	247	METZENBAUM SCS TC CVD SH/BL 14.5 CM	48
MAYO-ROBSON, INTESTINAL CLAMP FORCEPS,	248	METZENBAUM SCS TC CVD SH/BL 18.0 CM	49
MAYO-ROBSON, INTESTINAL CLAMP FORCEPS,	248	METZENBAUM SCS TC CVD SH/BL 20.0 CM	49
MAYO-ROBSON, INTESTINAL CLAMP FORCEPS,	248	METZENBAUM SCS TC CVD SH/BL 23.0 CM	49
MAYO-ROBSON, INTESTINAL CLAMP FORCEPS,	248	METZENBAUM SCS TC CVD SH/BL 25.0 CM	49
MAYO-ROBSON, INTESTINAL CLAMP FORCEPS,	248	METZENBAUM SCS TC CVD SH/BL 28.0 CM	49

Alphabetisches Inhaltsverzeichnis
Alphabetical Index

METZENBAUM SCS TC CVD SH/BL 30.0 CM	49	METZENBAUM-FINO SCS TC CVDSH 23.0CM	50
METZENBAUM SCS TC CVD SH/SH 14.5 CM	48	METZENBAUM-FINO SCS TC CVDSH 25.0CM	50
METZENBAUM SCS TC CVD SH/SH 18.0 CM	49	METZENBAUM-FINO SCS TC CVDSH 28.0CM	50
METZENBAUM SCS TC CVD SH/SH 20.0 CM	49	METZENBAUM-FINO SCS TC CVDSH 30.0CM	50
METZENBAUM SCS TC CVD SH/SH 23.0 CM	49	METZENBAUM-FINO SCS TC STR BL20.0CM	50
METZENBAUM SCS TC CVD SH/SH 25.0 CM	49	METZENBAUM-FINO SCS TC STR BL23.0CM	50
METZENBAUM SCS TC CVD SH/SH 28.0 CM	49	METZENBAUM-FINO SCS TC STR BL25.0CM	50
METZENBAUM SCS TC CVD SH/SH 30.0 CM	49	METZENBAUM-FINO SCS TC STR BL28.0CM	50
METZENBAUM SCS TC STR BL/BL 14.5 CM	48	METZENBAUM-FINO SCS TC STR BL30.0CM	50
METZENBAUM SCS TC STR BL/BL 18.0 CM	48	METZENBAUM-FINO SCS TC STR SH18.0CM	50
METZENBAUM SCS TC STR BL/BL 20.0 CM	48	METZENBAUM-FINO SCS TC STR SH20.0CM	50
METZENBAUM SCS TC STR BL/BL 23.0 CM	48	METZENBAUM-FINO SCS TC STR SH23.0CM	50
METZENBAUM SCS TC STR BL/BL 25.0 CM	48	METZENBAUM-FINO SCS TC STR SH25.0CM	50
METZENBAUM SCS TC STR BL/BL 28.0 CM	48	METZENBAUM-FINO SCS TC STR SH28.0CM	50
METZENBAUM SCS TC STR BL/BL 30.0 CM	48	METZENBAUM-FINO SCS TC STR SH30.0CM	50
METZENBAUM SCS TC STR SH/SH 18.0 CM	49	METZENBAUM-FINO SCS TC STRBL 18.0CM	50
METZENBAUM SCS TC STR SH/BL 20.0 CM	49	METZENBAUM-FINO TC CVD BL/BL 14.5 CM	49
METZENBAUM SCS TC STR SH/BL 23.0 CM	49	METZENBAUM-FINO TC CVD SH/SH 14.5 CM	49
METZENBAUM SCS TC STR SH/BL 25.0 CM	49	METZENBAUM-FINO TC STR BL/BL 14.5 CM	49
METZENBAUM SCS TC STR SH/BL 28.0 CM	49	METZENBAUM-FINO TC STR SH/SH 14.5 CM	49
METZENBAUM SCS TC STR SH/BL 30.0 CM	49	METZENBAUM-FINO, DISSEC.-SCS.,	56
METZENBAUM SCS TC STR SH/SH 18.0 CM	49	METZENBAUM-FINO, DISSEC.-SCS., CRV	56
METZENBAUM SCS TC STR SH/SH 20.0 CM	49	METZENBAUM-FINO, DISSEC.-SCS., CRV. SC	56
METZENBAUM SCS TC STR SH/SH 23.0 CM	49	METZENBAUM-FINO, DISSEC.-SCS., CRV. SC	56
METZENBAUM SCS TC STR SH/SH 25.0 CM	49	METZENBAUM-LAHEY, DISSEC. SCS. TC,	50
METZENBAUM SCS TC STR SH/SH 28.0 CM	49	METZENBAUM-LAHEY, DISSEC. SCS., CURVED,	24
METZENBAUM SCS TC STR SH/SH 30.0 CM	49	METZENBAUM-NELSON SCS CVD BL/BL 18.0 CM	20
METZENBAUM SCS TC STRAIGHT SH/BL 14.5	48	METZENBAUM-NELSON SCS CVD BL/BL 20.0 CM	21
METZENBAUM SCS TC STRAIGHT SH/SH 14.5	48	METZENBAUM-NELSON SCS CVD BL/BL 23.0 CM	21
METZENBAUM SCS.CVD. 23,0 CM SC BL/BL	56	METZENBAUM-NELSON SCS CVD BL/BL 25.0 CM	21
METZENBAUM, NEEDLE HOLDER, 18,0 CM	125	METZENBAUM-NELSON SCS CVD BL/BL 28.0 CM	21
METZENBAUM-BABY CVD BL/BL 11.5 CM	10	METZENBAUM-NELSON SCS CVD BL/BL 30.0 CM	21
METZENBAUM-BABY STR BL/BL 11.5 CM	20	METZENBAUM-NELSON SCS CVD SH/BL 18.0 CM	21
METZENBAUM-DELICATE BL/BL CVD 14.5 CM	22	METZENBAUM-NELSON SCS CVD SH/BL 20.0 CM	21
METZENBAUM-DELICATE BL/BL CVD 18.0 CM	23	METZENBAUM-NELSON SCS CVD SH/BL 23.0 CM	21
METZENBAUM-DELICATE BL/BL CVD 23.0 CM	23	METZENBAUM-NELSON SCS CVD SH/BL 25.0 CM	21
METZENBAUM-DELICATE BL/BL CVD 25.0 CM	23	METZENBAUM-NELSON SCS CVD SH/BL 28.0 CM	21
METZENBAUM-DELICATE BL/BL CVD 28.0 CM	23	METZENBAUM-NELSON SCS CVD SH/BL 30.0 CM	21
METZENBAUM-DELICATE BL/BL CVD 30.0 CM	23	METZENBAUM-NELSON SCS CVD SH/SH 18.0 CM	22
METZENBAUM-DELICATE BL/BL STR 14.5 CM	22	METZENBAUM-NELSON SCS CVD SH/SH 20.0 CM	22
METZENBAUM-DELICATE BL/BL STR 14.5 CM	23	METZENBAUM-NELSON SCS CVD SH/SH 23.0 CM	22
METZENBAUM-DELICATE BL/BL STR 18.0 CM	22	METZENBAUM-NELSON SCS CVD SH/SH 25.0 CM	22
METZENBAUM-DELICATE BL/BL STR 20.0 CM	22	METZENBAUM-NELSON SCS CVD SH/SH 28.0 CM	22
METZENBAUM-DELICATE BL/BL STR 23.0 CM	22	METZENBAUM-NELSON SCS CVD SH/SH 30.0 CM	22
METZENBAUM-DELICATE BL/BL STR 25.0 CM	22	METZENBAUM-NELSON SCS STR BL/BL 18.0 CM	21
METZENBAUM-DELICATE BL/BL STR 28.0 CM	22	METZENBAUM-NELSON SCS STR BL/BL 20.0 CM	21
METZENBAUM-DELICATE BL/BL STR 30.0 CM	22	METZENBAUM-NELSON SCS STR BL/BL 23.0 CM	21
METZENBAUM-DELICATE SH/SH CVD 14.5 CM	23	METZENBAUM-NELSON SCS STR BL/BL 25.0 CM	21
METZENBAUM-DELICATE SH/SH CVD 18.0 CM	23	METZENBAUM-NELSON SCS STR BL/BL 28.0 CM	21
METZENBAUM-DELICATE SH/SH CVD 20.0 CM	23	METZENBAUM-NELSON SCS STR BL/BL 30.0 CM	21
METZENBAUM-DELICATE SH/SH CVD 23.0 CM	23	METZENBAUM-NELSON SCS STR SH/BL 18.0 CM	21
METZENBAUM-DELICATE SH/SH CVD 25.0 CM	23	METZENBAUM-NELSON SCS STR SH/BL 20.0 CM	21
METZENBAUM-DELICATE SH/SH CVD 28.0 CM	23	METZENBAUM-NELSON SCS STR SH/BL 23.0 CM	21
METZENBAUM-DELICATE SH/SH CVD 30.0 CM	23	METZENBAUM-NELSON SCS STR SH/BL 25.0 CM	21
METZENBAUM-DELICATE SH/SH STR 18.0 CM	23	METZENBAUM-NELSON SCS STR SH/BL 28.0 CM	21
METZENBAUM-DELICATE SH/SH STR 20.0 CM	23	METZENBAUM-NELSON SCS STR SH/BL 30.0 CM	21
METZENBAUM-DELICATE SH/SH STR 23.0 CM	23	METZENBAUM-NELSON SCS STR SH/SH 18.0 CM	22
METZENBAUM-DELICATE SH/SH STR 25.0 CM	23	METZENBAUM-NELSON SCS STR SH/SH 20.0 CM	22
METZENBAUM-DELICATE SH/SH STR 28.0 CM	23	METZENBAUM-NELSON SCS STR SH/SH 23.0 CM	22
METZENBAUM-DELICATE SH/SH STR 30.0 CM	23	METZENBAUM-NELSON SCS STR SH/SH 25.0 CM	22
METZENBAUM-FINO S, DISSEC. SCS.,	24	METZENBAUM-NELSON SCS STR SH/SH 28.0 CM	22
METZENBAUM-FINO S, DISSEC. SCS.,	24	METZENBAUM-NELSON SCS STR SH/SH 30.0 CM	22
METZENBAUM-FINO S, DISSEC. SCS.,	24	METZENBAUM-NELSON SCS STR SH/SH 30.0 CM	22
METZENBAUM-FINO S, DISSEC. SCS.,	24	MEYERDING RECTRACTOR 18CM 7X4MM	162
METZENBAUM-FINO S, DISSEC. SCS.,	24	MEYERDING RECTRACTOR 18CM 7X4MM	162
METZENBAUM-FINO S, DISSEC. SCS.,	24	MEYERDING RECTRACTOR 18CM 10X3MM	162
METZENBAUM-FINO S, DISSEC. SCS.,	24	MEYERDING RECTRACTOR 18CM 10X4MM	162
METZENBAUM-FINO S, DISSEC.-SCS. TC,	51	MEYERDING RECTRACTOR 18CM 16X5MM	162
METZENBAUM-FINO S, DISSEC.-SCS. TC,	51	MEYERDING RECTRACTOR 18CM 18X7MM	162
METZENBAUM-FINO S, DISSEC.-SCS. TC,	51	MEYERDING RETRACTOR 50X16 MM 22.5 CM	183
METZENBAUM-FINO S, DISSEC.-SCS. TC,	51	MEYERDING RETRACTOR 75X25 MM 22.5 CM	183
METZENBAUM-FINO S, DISSEC.-SCS. TC,	51	MEYERDING RETRACTOR 90X50 MM 22.5 CM	183
METZENBAUM-FINO S, DISSEC.-SCS. TC,	51	MICHEL CLIP FORCEPS 12.0 CM	154
METZENBAUM-FINO SCS TC CVD BL18,0CM	50	MICHEL CLIPS 10PACK = 1000 EA 12 X 3	155
METZENBAUM-FINO SCS TC CVD BL20.0CM	50	MICHEL CLIPS 10PACK = 1000 EA 14 x 3 MM	155
METZENBAUM-FINO SCS TC CVD BL23.0CM	50	MICHEL CLIPS 10PACK =1000 EA 11 X 2 MM	155
METZENBAUM-FINO SCS TC CVD BL25,0CM	50	MICHEL CLIPS 10PACK =1000 EA 16 X 3 MM	155
METZENBAUM-FINO SCS TC CVD BL28.0CM	50	MICHEL CLIPS 10PACK =1000 EA 18 X 3 MM	155
METZENBAUM-FINO SCS TC CVD BL30.0CM	50	MICHEL CLIPS 10PACK =1000 EA 20 X 3 MM	155
METZENBAUM-FINO SCS TC CVD SH20.0CM	50	MICHEL CLIPS 10PACK =1000 EA 22 X 3 MM	155
METZENBAUM-FINO SCS TC CVDSH 18.0CM	50	MICHEL CLIPS 10PACK =1000 EA 7.5 X	155

MICHEL SUTURE FORCEPS 12.0 CM	155	MINI-LANGENBECK RETRACTOR 10X6 MM	162
MICHEL, SUTURE INSTRUMENTS SET,	155	MINI-LANGENBECK RETRACTOR 17X5 MM	162
MICRO RYDER NEEDLE HOLDER TC 13.0 CM	136	MINI-LANGENBECK RETRACTOR 20X6 MM	162
MICRO RYDER NEEDLE HOLDER TC 15.0 CM	136	MINI-LANGENBECK RETRACTOR 22X8 MM	162
MICRO RYDER NEEDLE HOLDER TC 18.0 CM	136	MINI-ROUX, RETRACTOR, 14,0 CM	168
MICRO RYDER NEEDLE HOLDER TC 20.0 CM	136	MINI-TOWNSEND FCPS 21 CM 2,3X4 MM	288
MICRO RYDER NEEDLE HOLDER TC 23.0 CM	136	MIXING BOWL 110 MM	309
MICRO RYDER NEEDLE HOLDER TC 26.0 CM	136	MIXING BOWL 120 MM	309
MICRO SCISSORS 18,0 CM, 125°	60	MIXING BOWL 150 MM	309
MICRO SCISSORS 18,0 CM, 125° ANGLED	60	MIXING BOWL 40 MM	309
MICRO SCISSORS 18,0 CM, 25°	60	MIXING BOWL 60 MM	309
MICRO SCISSORS 18,0 CM, 25° ANGLED	60	MIXING BOWL 80 MM	309
MICRO SCISSORS 18,0 CM, 45°	60	MIXTER ARTERY FORCEPS FIG.1 22.0 CM	114
MICRO SCISSORS 18,0 CM, 45° ANGLED	60	MIXTER ARTERY FORCEPS CVD 15.5 CM	113
MICRO SCISSORS 18,0 CM, 60°	60	MIXTER FORCEPS FIG.2 25.0 CM	114
MICRO SCISSORS 18,0 CM, 60° ANGLED	60	MIXTER FORCEPS FIG.3 28.0 CM	114
MICRO SCISSORS 18,0 CM, 90°	60	MIXTER GALL STONE FCPS 22CM	232
MICRO SCISSORS 18,0 CM, 90° ANGLED	60	MIXTER OPERAT.AND GYN.SCISS. CVD 15.5	25
MICRO-ADSON DRESS. FORCEPS 12,0 CM	66	MIXTER OPERAT.AND GYN.SCISS. STR 15.5	25
MICRO-ADSON DRESS. FORCEPS 15,0 CM	66	MIXTER, DISSECTING FORCEPS, CVD, 19.0	113
MICRO-ADSON, DISSECTING AND LIGATURE	108	MIXTER, DISSECTING FORCEPS, CVD, 22.0	113
MICRO-ADSON, TISSUE FORCEPS	71	MIXTER, DISSECTING FORCEPS, CVD.23.0CM	113
MICRO-ADSON, TISSUE FORCEPS	71	MIXTER-O'SHAUGNESSY ART.FCPS CVD 15.5	113
MICRO-FORCEPS, SELFRETAINING, SMOOTH,	78	MIXTER-O'SHAUGNESSY ART.FCPS CVD,19.0CM	113
MICRO-MOSQUITO ART.FCPS 1X2 CVD 12.0 CM	101	MOCK, IRRIGATION CANNULA, 6,0 CM	224
MICRO-MOSQUITO ART.FCPS 1X2 STR 10.0 CM	101	MOD.BONN SCISSORS CVD 8.0 CM	30
MICRO-MOSQUITO ART.FCPS 1X2 STR 12.0 CM	101	MOD.BONN SCISSORS RIGHT CVD 8,0 CM	30
MICRO-MOSQUITO ARTERY FORCEPS CVD	101	MOD.BONN SCISSORS STR 8.0 CM	30
MICRO-MOSQUITO FCPS 1X2 CVD 10.0 CM	101	MOD.USA TISSUE FCPS 1X2 TEETH 12.0 CM	71
MICRO-MOSQUITO FORCEPS CVD 12.0CM	101	MOD.USA TISSUE FCPS 1X2 TEETH 13.0 CM	71
MICRO-MOSQUITO FORCEPS STR 10.0CM	101	MOD.USA TISSUE FCPS 1X2 TEETH 14.5 CM	71
MICRO-MOSQUITO FORCEPS STR 12.0CM	101	MOD.USA TISSUE FCPS 1X2 TEETH 15.5 CM	71
MICRO-NEEDLE HOLDER, CURVED, 0,4 MM	132	MOD.USA TISSUE FCPS 1X2 TEETH 18.0 CM	71
MICRO-NEEDLE HOLDER, CURVED, 18,5 CM	131	MOD.USA TISSUE FCPS 1X2 TEETH 21.0 CM	71
MICRO-NEEDLE HOLDER, CURVED, W.	132	MOD.USA TISSUE FCPS 1X2 TEETH 25.0 CM	71
MICRO-NEEDLE HOLDER, ROUND HANDLE Ø 10	132	MOD.USA TISSUE FCPS 1X2 TEETH 30.0 CM	71
MICRO-NEEDLE HOLDER, ROUND HANDLE Ø 10	132	MOD.USA TISSUE FCPS 2X3 TEETH 13.0 CM	71
MICRO-NEEDLE HOLDER, ROUND HANDLE Ø 8	132	MOD.USA TISSUE FCPS 2X3 TEETH 14.5 CM	71
MICRO-NEEDLE HOLDER, ROUND HANDLE Ø 8	132	MOD.USA TISSUE FCPS 2X3 TEETH 15.5 CM	71
MICRO-NEEDLE HOLDER, STRAIGHT, 0,4 MM	132	MOD.USA TISSUE FORCEPS 2X3 TEETH 12.0	71
MICRO-NEEDLE HOLDER, STRAIGHT, 18,5 CM	131	MOD.USA TISSUE FORCEPS 2X3 TEETH 18.0	71
MICRO-NEEDLE HOLDER, WITH RATCHET,	131	MOD.USA TISSUE FORCEPS 2X3 TEETH 21.0	71
MICRO-NEEDLE HOLDER, WITH RATCHET,	131	MOD.USA TISSUE FORCEPS 2X3 TEETH 25.0	71
MICRO-SCS., FLAT-HANDLE, ANGLED, SH/SH,	59	MOD.USA TISSUE FORCEPS 2X3 TEETH 30.0	71
MICRO-SCS., FLAT-HANDLE, CURVED, SH/SH,	59	MOD.USA UMBILICAL SCISSORS 10.5 CM	43
MICRO-SCS., FLAT-HANDLE, STRAIGHT,	59	MOD.WIEN LIGATURE CATCHER 23.5 CM	154
MIDDELDORPF RETRACTOR 14X17 MM 21.5 CM	177	MOLLISON RETRACTOR SHARP 15.5 CM	190
MIDDELDORPF RETRACTOR 14X17 MM 21.5 CM	177	MOORE, GALL BLADDER SCOPE, 30,0 CM	235
MIDDELDORPF RETRACTOR 20X22 MM 22.0 CM	177	MORGAN-	254
MIDDELDORPF RETRACTOR 20X22 MM 22.0 CM	177	MORGAN, PROCTOSCOPE, Ø 17 X 65 MM	254
MIDDELDORPF RETRACTOR 26X30 MM 23.5 CM	177	MORGAN, PROCTOSCOPE, Ø 17 X 80 MM	254
MIDDELDORPF RETRACTOR 26X30 MM 23.5 CM	177	MORGAN, PROCTOSCOPE, Ø 20 X 65 MM	254
MIDDELDORPF, RETRACTOR, 40x45 MM, 25,5CM	178	MORGAN, PROCTOSCOPE, Ø 20 X 80 MM	254
MIDDELDORPF, RETRACTOR, 45X50 MM, 25,5CM	178	MORGAN, PROCTOSCOPE, Ø 24 X 65 MM	254
MIDDELDORPF, RETRACTOR, 55X70 MM, 25,5CM	178	MORGAN, PROCTOSCOPE, Ø 24 X 80 MM	254
MIKULICZ PERIT.CLAMP-FCPS 1X2 T 18.0 CM	118	MORRIS, RETRACTOR 70X50 MM 24,5 CM	181
MIKULICZ PERIT.CLAMP-FCPS 1X2 T. 20.0	118	MORRIS, RETRACTOR, 70X38 MM 24,5 CM	181
MIKULICZ RETRACTOR 120X50 MM 26.0 CM	181	MOYNIHAN FORCEPS 24.0 CM	120
MIKULICZ RETRACTOR 150X50 MM 26.0 CM	181	MOYNIHAN HYSTERECTOMY FORCEPS 23.0 CM	120
MIKULICZ RETRACTOR 85X35 MM 26.0 CM	181	MOYNIHAN, GALL STONE PROBE AND SCOOP,	234
MIKULICZ RETRACTOR 90X50 MM 26.0 CM	181	MUSEUX, UTERINE TENACULUM FORCEPS, 2X2	275
MILAN BIOPSY CURETTE 6MM, 28.0CM	278	MUSEUX, UTERINE TENACULUM FORCEPS, 2X2	275
MILAN BIOPSY CURETTE 9MM, 28.0CM	278	MUSEUX, UTERINE TENACULUM FORCEPS, 2X2	275
MILAN BIOPSY CURETTES 4MM, 28.0CM	278	MUSEUX, UTERINE TENACULUM FORCEPS, 2X2	275
MILKULICZ, SIGMOID ANASTOMOSIS FORCEPS,	251	MUSEUX, UTERINE TENACULUM FORCEPS, 2X2	275
MILLIGAN, SELF-RETAINING RETRACTOR, 3x3	192	MUSEUX, UTERINE TENACULUM FORCEPS, 2X2	275
MILLIN, BLADDER NECK SPREADER	238	MYRTLE LEAF PROBE 11,5 CM	214
MILLIN, BLADDER RETRACTOR CENTRAL VALVE	237	MYRTLE LEAF PROBE 13,0 CM	214
MILLIN, BLADDER RETRACTOR LATERAL VALVES	237	MYRTLE LEAF PROBE 14.5 CM	214
MILLIN, BLADDER RETRACTOR LATERAL VALVES	237	MYRTLE LEAF PROBE, 16.0 CM	214
MILLIN, BLADDER RETRACTOR, COMPLETE	237	MYRTLE LEAF PROBE, 18,0 CM	214
MILLIN, BLADDER RETRACTOR, ONLY	237	MYRTLE LEAF PROBE, 20.0 CM	214
MILLIN, CAPSULE FORCEPS	238	NABATOFF VARICOSE VEIN PROBE SET COMPL.	217
MILLIN, CAPSULE FORCEPS,	238	NABATOFF, CABLE FLEXIBLE STAINLESS	217
MILLIN, LIGATURE CARRYING FORCEPS	238	NABATOFF, HANDLE ONLY	217
MILLIN, PROSTATIC LOBE HOLDING FORCEPS	238	NABATOFF, METAL-CASE ONLY. 135X100X25	217
MINI-GEMINI, DISSECTING AND LIGATURE	112	NABATOFF, OLIVE ONLY, 12.0 MM	217
MINI-GEMINI, DISSECTING AND LIGATURE	112	NABATOFF, OLIVE ONLY, 6.0 MM	217
MINI-GEMINI, DISSECTING AND LIGATURE	112	NABATOFF, OLIVE ONLY, 9.0 MM	217
MINI-GEMINI, DISSECTING AND LIGATURE	112	NABATOFF, PROBE TIP PLASTIC MATERIAL	217

Alphabetisches Inhaltsverzeichnis
Alphabetical Index

NABATOFF, PROBE TIP ONLY METAL 3 MM	217	OPERATING KNIFE, FIG.14, SOLID HANDLE,	6
NAEGELE, OBSTETRICAL FORCEPS, 36,0 CM	290	OPERATING KNIFE, FIG.16, SOLID HANDLE,	6
NAEGELE, OBSTETRICAL FORCEPS, 40,0 CM	290	OPERATING KNIFE, FIG.18, SOLID HANDLE,	6
NAGER LIGATURE NEEDLE 24,0 CM	150	OPERATING SCISSORS, STANDARD	14
NAIL NIPPER FORCEPS, 13,0 CM	296	OSTEOTOME 10MM 13,5CM	304
NAIL NIPPER FORCEPS, 13,5 CM	296	OSTEOTOME 12MM 13,5 CM	304
NAIL NIPPER FORCEPS, WITH LOCK,	296	OSTEOTOME 14MM 13,5CM	304
NAIL NIPPER FORCEPS, WITH LOCK, CURVED	296	OSTEOTOME 16MM 13,5CM	304
NEEDLE CASE 65 X 17 MM	310	OSTEOTOME, 8MM, 13.5CM	304
NEEDLE CASE, INSERT ONLY, Ø 62X13 MM	310	O'SULLIVAN-O'CONNOR ABDOMINAL RETRACTOR	205
NEEDLE HOLDER, SWEDISH PATTERN, WITH	137	O'SULLIVAN-O'CONNOR BLADE 110X70 MM	205
NEEDLE HOLDER, SWEDISH PATTERN, WITH	137	O'SULLIVAN-O'CONNOR BLADE 80X45 MM	205
NEEDLE HOLDER, SWEDISH PATTERN, WITH	137	O'SULLIVAN-O'CONNOR FRAME	205
NEEDLE LARGE	149	OVERHOLT ART.FCPS S-SHAPED 21.0 CM	109
NEEDLE MEDIUM	149	OVERHOLT ART.FCPS S-SHAPED 21.5 CM	109
NEEDLE SMALL	149	OVERHOLT ART.FCPS.S-SHAPED 18,5 CM	109
NEGUS GALL DUCT CLAMP FIG.1 19,0 CM	107	OVERHOLT ART.FCPS.S-SHAPED 20.5 CM	109
NEGUS GALL DUCT CLAMP FIG.2 19,0 CM	107	OVERHOLT-GEISSENDOERFER FIG.1 21.0 CM	110
NEIVERT NEEDLE HOLDER SMOOTH JAWS	124	OVERHOLT-GEISSENDOERFER FIG.1 27.0 CM	110
NELATON PROBE 16,0 CM	214	OVERHOLT-GEISSENDOERFER FIG.2 21.0 CM	110
NELSON TROCAR FIG.1, Ø 7.5 MM 21,0 CM	220	OVERHOLT-GEISSENDOERFER FIG.2 27.0 CM	110
NELSON TROCAR FIG.2, Ø 9.5 MM 21,0 CM	220	OVERHOLT-GEISSENDOERFER FIG.3 21.0 CM	110
NELSON TROCAR FIG.3, Ø 11.0 MM 21,0 CM	220	OVERHOLT-GEISSENDOERFER FIG.3 27.0 CM	110
NELSON TROCAR FIG.4, Ø 12.5 MM 21,0 CM	220	OVERHOLT-GEISSENDOERFER FIG.4 21.0 CM	110
NELSON, GRASPING FORCEPS 15,0 CM	75	OVERHOLT-GEISSENDOERFER FIG.4 27.0 CM	110
NELSON, GRASPING FORCEPS 20,0 CM	75	OVERHOLT-GEISSENDOERFER FIG.5 21.0 CM	110
NELSON, GRASPING FORCEPS 23,0 CM	75	OVERHOLT-GEISSENDOERFER FIG.5 27.0 CM	110
NERVE DISSECTING SCISSORS CVD 15,0 CM	27	OVERHOLT-GEISSENDOERFER FIG.6 21.0 CM	110
NERVE DISSECTING SCISSORS STR 15,0 CM	27	OVERHOLT-GEISSENDOERFER FIG.6 27.0 CM	110
NON-TRAUMATIC HAEMORRHOIDAL FORCEPS	97	OVERHOLT-GEISSENDOERFER FIG.7 21.0 CM	110
NON-TRAUMATIC HAEMORRHOIDAL FORCEPS	97	OVERHOLT-GEISSENDOERFER FIG.7 27.0 CM	110
NORFOLK/NORWICH, SELF-RETAINING	196	OVERHOLT-MIXTER FORCEPS CVD 21,0 CM	108
NORTHBENT LIGATURE SCISSORS 9,0 CM	34	PAR TYPE, FINE DISSEC. SCS., SC CRV.	58
NORTHBENT LIGATURE SCISSORS CVD 12,5 CM	34	PAR TYPE, FINE DISSEC. SCS., SC STRAIGHT	58
NOTO POLYPUS FORCEPS 27,5 CM	276	PARKER RETRACTOR SET SMALL FIG.1+2	168
NOVAK, SUCTION BIOPSY CURETTE,	278	PARKER-LANGENBECK SET FIG.1+2 21 CM	169
OCHSNER ENT TROCAR 4,6 mm 14 cm	220	PARTSCH BONE CHISEL WIDTH 3 MM 13,5 CM	304
OCHSNER TROCAR 14 cm 4 mm	220	PARTSCH BONE CHISEL WIDTH 4 MM 13,5 CM	304
OCHSNER TROCAR 5,5 mm 14 cm	220	PARTSCH BONE CHISEL WIDTH 5 MM 13,5 CM	304
OCHSNER TROCAR 6,5 mm 14 cm	220	PARTSCH BONE CHISEL WIDTH 6 MM 13,5 CM	304
OCHSNER, GALL DUCT PROBE, 35,0 CM	235	PARTSCH BONE GOUGE WIDTH 3 MM 13,5 CM	304
OCHSNER-KOCHER ART.FCPS.CVD 16,0 CM	106	PARTSCH BONE GOUGE WIDTH 4 MM 13,5 CM	304
OCHSNER-KOCHER ART.FCPS.CVD 26,0 CM	106	PARTSCH BONE GOUGE WIDTH 5 MM 13,5 CM	304
OCHSNER-KOCHER ART.FCPS.CVD 30,0 CM	106	PARTSCH BONE GOUGE WIDTH 6 MM 13,5 CM	304
OCHSNER-KOCHER ART.FCPS.STR 24,0 CM	106	PARTSCH MALLETT 200GR LEAD FILLED 18,0 CM	306
OCHSNER-KOCHER ART.FCPS.STR 26,0 CM	106	PAYR INT.CRUSHING CLAMP W.PIN 21,0 CM	249
OCHSNER-KOCHER ART.FCPS.STR 16,0 CM	106	PAYR INT.CRUSHING CLAMP W.PIN 29,0 CM	249
OCHSNER-KOCHER ART.FCPS.STR 22,0 CM	106	PAYR INT.CRUSHING CLAMP W/O PIN 21,0 CM	249
OCHSNER-KOCHER ART-FCPS.STR 30,0 CM	106	PAYR LIGATURE CONDUCTOR CVD. 22,0 CM	152
OCHSNER-KOCHER FCPS CVD 18,0 CM	106	PAYR LIGATURE CONDUCTOR STR 22,0 CM	152
OCHSNER-KOCHER FCPS. CVD. 14,0 CM	106	PAYR-BABY INT.CRUSHING CLAMP 15,0 CM	249
OCHSNER-KOCHER FCPS. STR. 14,0 CM 1x2 T	106	PAYR-BABY INT.CRUSHING CLAMP 15,0 CM	249
OCHSNER-KOCHER FCPS.CVD 20,0 CM	106	PEAN ARTERY FORCEPS STRAIGHT 14,0 CM	99
OCHSNER-KOCHER FCPS.CVD 22,0 CM	106	PEAN ARTERY FORCEPS STRAIGHT 16,0 CM	99
OCHSNER-KOCHER FCPS.CVD 24,0 CM	106	PEAN-DELICATE ART.FCPS.CVD 13,0 CM	105
OCHSNER-KOCHER FCPS.CVD 24,0 CM	106	PEAN-DELICATE ART.FCPS.CVD 16,0 CM	105
OCHSNER-KOCHER FCPS.STR 18,0 CM	106	PEAN-DELICATE ART.FCPS.STR 13,0 CM	105
OCHSNER-KOCHER FCPS.STR 20,0 CM	106	PEAN-DELICATE ART.FCPS.STR 16,0 CM	105
O'CONNOR DELICATE HOOK 16,0 CM	158	PEAN-DELICATE FCPS.CVD 14,0 CM	105
OLIVE ONLY	222	PEAN-DELICATE FCPS.STR 14,0 CM	105
OLSEN-HEGAR NEEDLE HOLDER/SCS 14,0 CM	128	PEAN-DELICATE VAGINAL SPECULUM 100X22 MM	260
OLSEN-HEGAR NEEDLE HOLDER/SCS 17,0 CM	128	PEDERSON VAGINAL SPECULUM 120X25 MM	260
OLSEN-HEGAR NEEDLE HOLDER/SCS 19,0 CM	128	PEDERSON VAGINAL SPECULUM 75X13 MM	260
OLSEN-HEGAR NEEDLE HOLDER/SCS. TC 14 CM	140	PEERS TOWEL FORCEPS 14,5 CM	88
OLSEN-HEGAR NEEDLE HOLDER/SCS. TC 17 CM	140	PELKMANN DRESSING FORCEPS CVD 25,0 CM	89
OLSEN-HEGAR, NEEDLE HOLDER/SCS., 14,0	128	PELKMANN DRESSING FORCEPS STR 25,0 CM	89
OLSEN-HEGAR, NEEDLE HOLDER/SCS., WITH	140	PENNINGTON FORCEPS 15,5 CM	97
OP.SCISSORS GRAZIL CVD BL/BL 13,0 CM	17	PENNINGTON FORCEPS 20,0 CM	97
OP.SCISSORS GRAZIL CVD BL/BL 14,5 CM	17	PESTALOZZA, OVUM CURETTE, 30,0 CM	291
OP.SCISSORS GRAZIL CVD SH/BL 13,0 CM	17	PHALANGAL KNIFE,	9
OP.SCISSORS GRAZIL CVD SH/BL 14,5 CM	17	PHANEUF FCPS.CVD 1X2 T 21,5 CM	119
OP.SCISSORS GRAZIL CVD SH/SH 13,0 CM	18	PHANEUF FCPS.STR 1X2 T 21,5 CM	119
OP.SCISSORS GRAZIL CVD SH/SH 14,5 CM	18	PIERCE ANTRUM TROCAR W.TUB.CONN. 3,0 MM	220
OP.SCISSORS GRAZIL STR BL/BL 13,0 CM	17	PIERCE ANTRUM TROCAR W.TUB.CONN. 4,0 MM	220
OP.SCISSORS GRAZIL STR BL/BL 13,0 CM	17	PIERCE ANTRUM TROCAR W.TUB.CONN. 5,0 MM	220
OP.SCISSORS GRAZIL STR BL/BL 14,5 CM	17	PIFFARD, LUPUS CURETTE, Ø 3 MM, 14,0 CM	294
OP.SCISSORS GRAZIL STR SH/BL 13,0 CM	17	PIFFARD, LUPUS CURETTE, Ø 4 MM, 14,0 CM	294
OP.SCISSORS GRAZIL STR SH/BL 14,5 CM	17	PIFFARD, LUPUS CURETTE, Ø 5 MM, 14,0 CM	294
OP.SCISSORS GRAZIL STR SH/SH 14,5 CM	18	PIPER, OBSTETRICAL FORCEPS, 44,0 CM	290
OPERATING KNIFE, FIG.10, SOLID HANDLE,	6		
OPERATING KNIFE, FIG.12, SOLID HANDLE,	6		

PLASTER-OF-PARIS SHEARS 20.0 CM	45	PROBE W.EYE 18.0 CM 2 MM	214
PLESTER, RETRACTOR LEFT 11.0 CM	192	PROBE W.EYE 20.0 CM 2 MM	214
PLESTER, RETRACTOR RIGHT 11.0 CM	192	PROVIDENCE-HOSPITAL ART.FCPS STR 14.0	100
PLESTER, SELF-RETAINING RETRACTOR, 2x2	192	PROVIDENCE-HOSPITAL FCPS CVD 14.0 CM	100
PLESTER, SELF-RETAINING RETRACTOR, 2x2	192	PYE-SMITH (HARRISON), STERILIZING	308
POOLE SUCTION TUBE CURVED, Ø 6 MM, 22.0	221	QUINKE, LUMBAR PUNCTURE NEEDLE, Ø 0,7 X	226
POOLE SUCTION TUBE CURVED, Ø 8 MM, 22,0	221	QUINKE, LUMBAR PUNCTURE NEEDLE, Ø 0,7 X	226
POOLE, SUCTION TUBE, STRAIGHT, Ø 10,0	221	QUINKE, LUMBAR PUNCTURE NEEDLE, Ø 0,7 X	226
POOLE, SUCTION TUBE, STRAIGHT, Ø 6,0	221	QUINKE, LUMBAR PUNCTURE NEEDLE, Ø 1,0 X	226
POPPEN SUCTION TUBE CHARR. 10 13 CM	223	QUINKE, LUMBAR PUNCTURE NEEDLE, Ø 1,0 X	226
POPPEN SUCTION TUBE CHARR. 12 13 CM	223	QUINKE, LUMBAR PUNCTURE NEEDLE, Ø 1,2 X	226
POPPEN SUCTION TUBE CHARR. 6 13 CM	223	QUINKE, LUMBAR PUNCTURE NEEDLE, Ø 1,2 X	226
POPPEN SUCTION TUBE CHARR. 8 13 CM	223	RADOLF NAIL FORCEPS 13,5CM	296
POTTS DE MARTEL, VASCULAR SCS. TC, 24.0	53	RAGNELL, RETRACTOR DOUBLE-ENDED, 8x3/	163
POTTS, VASCULAR SCS., SC, 25°, SH/SH 19	58	RAGNELL-DAVIS RETRACTOR 14.0 CM	163
POTTS, VASCULAR SCS., SC, 45°, SH/SH 19CM	58	RAMPLEY SPONGE HOLDING FORCEPS 18.0 CM	90
POTTS, VASCULAR SCS., SC, 60°, SH/SH 19CM	58	RAMPLEY SPONGE HOLDING FORCEPS 25.0 CM	90
POTTS-DE MARTEL, VASCULAR SCISSORS	37	RAMSEY, DRESSING FORCEPS, 18.0 CM	68
POTTS-DE MARTEL, VASCULAR SCISSORS,	37	RAMSEY, TISSUE FCPS., 1X2 TEETH, 18.0	76
POTTS-SMITH ART.SCS 25 DEGREE 19.0 CM	38	RAMSEY, TISSUE FCPS., 2X3 TEETH, 18.0	76
POTTS-SMITH ART.SCS 45 DEGREE 19.0 CM	38	RANDALL KIDNEY STONE FCPS FIG.1 23.0 CM	232
POTTS-SMITH ART.SCS 60 DEGREE 19.0 CM	38	RANDALL KIDNEY STONE FCPS FIG.2 22.0 CM	232
POTTS-SMITH, TISSUE FORCEPS,	74	RANDALL KIDNEY STONE FCPS FIG.3 22.0 CM	232
POTTS-SMITH, DISSECTING SCISSORS, 19.0	42	RANDALL KIDNEY STONE FCPS FIG.4 22.0 CM	232
POTTS-SMITH, DRESSING FCPS., TC, 15.0	83	RANDALL KIDNEY STONE FCPS.FIG.5 19,0 CM	232
POTTS-SMITH, DRESSING FCPS., TC, 18.0	83	RANDALL KIDNEY STONE FCPS.FIG.6 19,0 CM	232
POTTS-SMITH, DRESSING FCPS., TC, 20.0	83	RANDALL, SUCTION BIOPSY CURETTE	278
POTTS-SMITH, DRESSING FORCEPS,	67	RECAMIER CURETTE, MALLEABLE SHARP	284
POTTS-SMITH, DRESSING FORCEPS,	67	RECAMIER CURETTE, MALLEABLE SHARP	284
POTTS-SMITH, DRESSING FORCEPS,	67	RECAMIER, UTERINE CURETTE, SHARP,	280
POTTS-SMITH, DRESSING FORCEPS,	67	RECAMIER, UTERINE CURETTE, SHARP,	280
POTTS-SMITH, DRESSING FORCEPS,	67	RECAMIER, UTERINE CURETTE, SHARP,	280
POTTS-SMITH, DRESSING FORCEPS,	67	RECAMIER, UTERINE CURETTE, SHARP,	280
POTTS-SMITH, DRESSING FORCEPS,	67	RECAMIER, UTERINE CURETTE, SHARP,	280
POTTS-SMITH, TISSUE FORCEPS,	74	RECAMIER, UTERINE CURETTE, SHARP,	280
POTTS-SMITH, TISSUE FORCEPS,	74	RECAMIER, UTERINE CURETTE, SHARP,	280
POTTS-SMITH, TISSUE FORCEPS,	74	RECAMIER, UTERINE CURETTE, SHARP,	280
POTTS-SMITH, TISSUE FORCEPS,	74	RECAMIER, UTERINE CURETTE, SHARP,	280
POTTS-SMITH, TISSUE FORCEPS,	74	RECAMIER, UTERINE CURETTE, SHARP,	280
POTTS-SMITH, TISSUE FORCEPS,	74	RECAMIER, UTERINE CURETTE, SHARP,	280
POTTS-SMITH, VASCULAR SCISSORS TC 25°	54	RECAMIER, UTERINE CURETTE, SHARP,	280
POTTS-SMITH, VASCULAR SCISSORS,	37	RECAMIER, UTERINE CURETTE, SHARP,	280
POTTS-SMITH, VASCULAR SCISSORS,TC 40°	54	RECAMIER, UTERINE CURETTE, SHARP,	280
POTTS-SMITH, VASCULAR SCISSORS,TC 60°	54	RECAMIER, UTERINE CURETTE, SHARP,	280
POZZI, UTERINE TENACULUM FORCEPS,	273	RECAMIER, UTERINE CURETTE, SHARP,	282
PRATT FISTULA HOOK 21,0 CM FIG.1	256	RECAMIER, UTERINE CURETTE, SHARP,	282
PRATT FISTULA HOOK 21,0 CM FIG.2	256	RECAMIER, UTERINE CURETTE, SHARP,	282
PRATT FISTULA HOOK 21,0 CM FIG.3	256	RECAMIER, UTERINE CURETTE, SHARP,	282
PRATT HAEMORRHOIDAL FORCEPS 15,0 CM	98	RECAMIER, UTERINE CURETTE, SHARP,	282
PRATT SET OF 8 DILAT. 4.5/5-13.6/14.3MM	272	RECAMIER, UTERINE CURETTE, SHARP,	282
PRATT UTERINE DILAT.F.37/39, 12.3/13MM	272	RECAMIER, UTERINE CURETTE, SHARP,	282
PRATT UTERINE DILAT.F.41/43, 13.6/14.3MM	272	RECAMIER, UTERINE CURETTE, SHARP,	282
PRATT UTERINE DILAT.FIG.33/35,11,5/12 MM	272	RECAMIER, UTERINE CURETTE, SHARP,	282
PRATT UTERINE DILATOR F.17/19,5,5/6 MM	272	RECAMIER, UTERINE CURETTE, SHARP,	282
PRATT UTERINE DILATOR F.29/31, 9,5/10 MM	272	RECAMIER, UTERINE CURETTE, SHARP,	282
PRATT UTERINE DILATORS F.13/15, 4,5/5MM	272	RECAMIER, UTERINE CURETTE, SHARP,	282
PRATT UTERINE DILATORS F.21/23, 7,5/8 M	272	RECAMIER, UTERINE CURETTE, SHARP,	282
PRATT UTERINE DILATORS F.25/27, 8,5/9MM	272	RECAMIER, UTERINE CURETTE, SHARP,	282
PRATT VULSELLUM FORCEPS 4X4 T. 28.0 CM	275	RECAMIER, UTERINE CURETTE, SHARP,	282
PRESBYTERIAN CLAMP 16.5 CM	91	RECAMIER, UTERINE CURETTE, SHARP,	282
PRESBYTERIAN TUBING CLAMP 18.0 CM	91	RECAMIER, UTERINE CURETTE, SHARP,	282
PRESBYTERIAN, TUBING CLAMP, 20.0 CM	91	RECAMIER, UTERINE CURETTE, SHARP,	282
PRICE-THOMAS FORCEPS 22,0 CM	117	RECAMIER, UTERINE CURETTE, SHARP,	282
PRICE-THOMAS FORCEPS 22,0 CM	118	RECAMIER, UTERINE CURETTE, SHARP,	282
PRICE-THOMAS FORCEPS 22,0 CM	118	RECAMIER, UTERINE CURETTE, SHARP,	282
PRICE-THOMAS FORCEPS 22,0 CM	118	RECAMIER, UTERINE CURETTE, SHARP,	282
PRINCE TONSIL SCISSORS CVD 17.5 CM	36	RECAMIER, UTERINE CURETTE, SHARP,	282
PROBE + DIRECTOR 11.5 CM 1 MM	214	RECAMIER, UTERINE CURETTE, SHARP,	282
PROBE + DIRECTOR 11.5 CM 2 MM	214	RECAMIER, UTERINE CURETTE, SHARP,	282
PROBE + DIRECTOR 13.0 CM 1 MM	214	RECAMIER, UTERINE CURETTE, SHARP,	282
PROBE + DIRECTOR 13.0 CM 2 MM	214	RECAMIER, UTERINE CURETTE, SHARP,	282
PROBE + DIRECTOR 14.5 CM 1 MM	214	RECAMIER, UTERINE CURETTE, SHARP,	282
PROBE + DIRECTOR 14.5 CM 2 MM	214	RECAMIER, UTERINE CURETTE, SHARP,	282
PROBE + DIRECTOR 16.0 CM 1 MM	214	RECAMIER, UTERINE CURETTE, SHARP,	280
PROBE + DIRECTOR 16.0 CM 2 MM	214	RECAMIER, UTERINE CURETTE, SHARP, RIGID	280
PROBE + DIRECTOR 18.0 CM 1 MM	214	RECAMIER, UTERINE CURETTE, SHARP, RIGID,	280
PROBE + DIRECTOR 18.0 CM 2 MM	214	RECAMIER, UTERINE CURETTE, SHARP, RIGID,	280
PROBE + DIRECTOR 20.0 CM 1 MM	214	RECAMIER, UTERINE CURETTE, SHARP, RIGID,	280
PROBE + DIRECTOR 20.0 CM 2 MM	214	RECAMIER, UTERINE CURETTE, SHARP, RIGID,	280
PROBE W.EYE 11.5 CM 2 MM	214	RECAMIER, UTERINE CURETTE, SHARP, RIGID,	280
PROBE W.EYE 13.0 CM 2 MM	214	RECAMIER, UTERINE CURETTE, SHARP, RIGID,	280
PROBE W.EYE 14.5 CM 2 MM	214	RECAMIER, UTERINE CURETTE, SHARP, RIGID,	280
PROBE W.EYE 16.0 CM 2 MM	214	RECAMIER, UTERINE CURETTE, SHARP, RIGID,	280

Alfabetisches Inhaltsverzeichnis
Alphabetical Index

RECAMIER, UTERINE CURETTE, SHARP, RIGID,	280	ROCHARD, ABDOMINAL RETRACTOR, 105X48 MM	209
RECAMIER, UTERINE CURETTE, SHARP, RIGID,	280	ROCHARD, ABDOMINAL RETRACTOR, 115X48 MM	209
RECAMIER, UTERINE CURETTE, SHARP, RIGID,	280	ROCHARD, ABDOMINAL RETRACTOR, 125X48 MM	209
RECAMIER, UTERINE CURETTE, SHARP, RIGID,	280	ROCHARD, ABDOMINAL RETRACTOR, 155X48 MM	209
RECTAL, RECTAL SCS., CURVED, BL/BL,	42	ROCHARD, ABDOMINAL RETRACTOR, 95X48 MM	209
RETRACTOR BLUNT 1 PRONG 16.0 CM	160	ROCHARD, FIXATION DEVICE FOR ABDOMINAL	209
RETRACTOR BLUNT 2 PRONGS 16.0 CM	160	ROCHARD, MOUNTING FRAME WITH 1 ARM	209
RETRACTOR BLUNT 3 PRONGS 16.0 CM	160	ROCHARD, MOUNTING FRAME WITH 2 ARMS	209
RETRACTOR BLUNT 4 PRONGS 16.0 CM	160	ROCHESTER-CARMALT FCPS CVD 16.0 CM	105
RETRACTOR BLUNT FLEX 3 PRONGS 16.0 CM	160	ROCHESTER-CARMALT FCPS CVD 20.0 CM	105
RETRACTOR BLUNT FLEX 4 PRONGS 16.0 CM	160	ROCHESTER-CARMALT FCPS STR 16.0 CM	105
RETRACTOR BLUNT FLEX.2 PRONGS 16.0 CM	160	ROCHESTER-CARMALT FCPS STR 20.0 CM	105
RETRACTOR SEMI-SHARP 1 PRONG 16.0 CM	160	ROCHESTER-PEAN ARTERY FCPS CVD 26.0 CM	106
RETRACTOR SEMI-SHARP 2 PRONGS 16.0 CM	160	ROCHESTER-PEAN ARTERY FCPS STR 16.0 CM	106
RETRACTOR SEMI-SHARP 3 PRONGS 16.0 CM	160	ROCHESTER-PEAN ARTERY FCPS STR 18.0 CM	106
RETRACTOR SEMI-SHARP 4 PRONGS 16.0 CM	160	ROCHESTER-PEAN ARTERY FCPS STR 20.0 CM	106
RETRACTOR SHARP 1 PRONG 16.0 CM	160	ROCHESTER-PEAN ARTERY FCPS STR 24.0 CM	106
RETRACTOR SHARP 2 PRONGS 16.0 CM	160	ROCHESTER-PEAN ARTERY FCPS STR 26.0 CM	106
RETRACTOR SHARP 3 PRONGS 16.0 CM	160	ROCHESTER-PEAN ARTERY FCPS STR 30.0 CM	106
RETRACTOR SHARP 4 PRONGS 16.0 CM	160	ROCHESTER-PEAN FCPS CVD 14.0 CM	106
RETRACTOR SHARP FLEX. 2 PRONGS 16.0 CM	160	ROCHESTER-PEAN FCPS CVD 16.0 CM	106
RETRACTOR SHARP FLEX. 3 PRONGS 16.0 CM	160	ROCHESTER-PEAN FCPS CVD 18.0 CM	106
RETRACTOR SHARP FLEX. 4 PRONGS 16.0 CM	160	ROCHESTER-PEAN FCPS CVD 20.0 CM	106
RETRACTOR, 2 PRONG, 14x8 MM, BLUNT,	162	ROCHESTER-PEAN FCPS CVD 22.0 CM	106
REVERDIN NEEDLE FIG.1 14.0 CM	145	ROCHESTER-PEAN FCPS CVD 24.0 CM	106
REVERDIN NEEDLE FIG.1 19.5 CM	145	ROCHESTER-PEAN FCPS CVD 30.0 CM	106
REVERDIN NEEDLE FIG.1 22.5 CM	145	ROCHESTER-PEAN FCPS STR 14.0 CM	106
REVERDIN NEEDLE FIG.2 14.0 CM	145	ROCHESTER-PEAN FCPS STR 22.0 CM	106
REVERDIN NEEDLE FIG.2 19.5 CM	145	ROEDER TOWEL FORCEPS 13.0 CM	86
REVERDIN NEEDLE FIG.2 22.5 CM	145	ROEDER TOWEL FORCEPS 15.0 CM	87
REVERDIN NEEDLE FIG.3 14.0 CM	145	ROGGE STERILIZING FORCEPS 23,0 CM	308
REVERDIN NEEDLE FIG.3 19.5 CM	145	ROUX RETRACTOR FIG.1 14 cm	167
REVERDIN NEEDLE FIG.3 22.5 CM	145	ROUX RETRACTOR FIG.2 15 CM	167
REVERDIN NEEDLE FIG.4 14.0 CM	145	ROUX RETRACTOR FIG.3 17 cm	167
REVERDIN NEEDLE FIG.4 19.5 CM	145	ROUX RETRACTOR SET FIG.1-3	167
REVERDIN NEEDLE FIG.4 22.5 CM	145	ROUX, RETRACTOR, FIG.4 18 CM	167
REVERDIN, ABDOMINAL SPATULA, 280 x	210	RUDD HAEMORRHOIDAL LIGATORS	255
REYNOLDS DISS.SCISSORS CVD SH 18.0 CM	26	RUMEL DISS.FORCEPS FIG.4, 23.0 CM	109
REYNOLDS DISS.SCISSORS CVD SH 20.0 CM	26	RUMEL FORCEPS FIG.1, 23.0 CM	109
REYNOLDS DISS.SCISSORS CVD SH 23.0 CM	26	RUMEL FORCEPS FIG.2, 23.0 CM	109
REYNOLDS DISS.SCISSORS STR BL 15.0 CM	26	RUMEL FORCEPS FIG.3, 23.0 CM	109
REYNOLDS DISS.SCISSORS STR BL 18.0 CM	26	RUSS.MODEL TISSUE FCPS 15.0 CM	74
REYNOLDS DISSECTING SCISSORS, SH	26	RUSS.MODEL TISSUE FCPS 20.0 CM	74
REYNOLDS, DISSEC.-SCS. TC, CURVED,15.0CM	51	RUSS.MODEL TISSUE FORCEPS 25.0 CM	74
REYNOLDS, DISSEC.-SCS. TC, STRAIGHT,	51	RYDER/FRENCH-EYE NEEDLE HOLDER TC 13 CM	137
REYNOLDS, DISSEC.-SCS., SC, ST, BL/BL	57	RYDER/FRENCH-EYE NEEDLE HOLDER TC 15 CM	137
REYNOLDS, DISSECTING SCISSORS,	25	RYDER/FRENCH-EYE NEEDLE HOLDER TC 18 CM	137
RIBBON, ABDOMINAL SPATULA, 200 x 12 MM,	210	RYDER/FRENCH-EYE NEEDLE HOLDER TC 20 CM	137
RIBBON, ABDOMINAL SPATULA, 200 x 17 MM,	210	RYDER/FRENCH-EYE NEEDLE HOLDER TC 23 CM	137
RIBBON, ABDOMINAL SPATULA, 200 x 20 MM,	210	RYDER/FRENCH-EYE NEEDLE HOLDER TC 26 CM	137
RIBBON, ABDOMINAL SPATULA, 200 x 25 MM,	210	SAALFELD, COMEDO EXTRACTOR, 10,0 CM	295
RIBBON, ABDOMINAL SPATULA, 200 x 6 MM,	210	SAALFELD, COMEDO EXTRACTOR, 14,0 CM	295
RIBBON, ABDOMINAL SPATULA, 330x13 MM,	210	SAENGER OVUM FORCEPS, CURVED, 27.0CM	291
RIBBON, ABDOMINAL SPATULA, 330x25 MM,	210	SANVENERO SCISSORS CVD SH/SH 14.0 CM	27
RIBBON, ABDOMINAL SPATULA, 330X32 MM,	210	SANVENERO SCISSORS STR SH/SH 14.0 CM	27
RIBBON, ABDOMINAL SPATULA, 330X40 MM,	210	SAROT ARTERY FORCEPS CVD 24.0 CM	107
RIBBON, ABDOMINAL SPATULA, 330X50 MM,	210	SAROT ARTERY FORCEPS STR 24.0 CM	107
RICARD ABDOMINAL RETRACTOR 280 MM OPEN.	198	SAROT NEEDLE HOLDER TC 18.0 CM	134
RICARD ABDOMINAL RETRACTOR 300MM	198	SAROT NEEDLE HOLDER TC 26.0 CM	134
RICARD, ABDOMINAL RETRACTOR,	200	SAROT, NEEDLE HOLDER WITH TC, 20,0 CM	134
RICARD, ABDOMINAL RETRACTOR,	200	SATINSKY ARTERY SCISSORS S-SHAPED	39
RICARD, ABDOMINAL RETRACTOR,	200	SAUERBRUCH RETRACTOR 44X16 MM 22.5 CM	176
RICHARDSON RETRACTOR 28X20 MM 24,0 CM	177	SAUERBRUCH RETRACTOR 55X22 MM 22.5 CM	176
RICHARDSON RETRACTOR 36X28 MM 24.0 CM	177	SAUERBRUCH RETRACTOR 72X19 MM 22.5 CM	176
RICHARDSON RETRACTOR 44X38 MM 24.0 CM	177	SAW BLADE ONLY, FOR 59-1420-17, Ø 30 MM	296
RICHARDSON RETRACTOR 52X22 MM 24.0 CM	177	SCALP-CONTOUR RETRACTOR BLUNT 14.0 CM	189
RICHARDSON RETRACTOR 65X50 MM 24.0 CM	177	SCALP-CONTOUR RETRACTOR SHARP 14.0 CM	189
RICHARDSON RETRACTOR, 70X65 MM 24 CM	177	SCALPEL HANDLE NO.3	2
RICHARDSON-EASTMAN RETRACTOR FIG.1 26	178	SCALPEL HANDLE NO.3 L CHR.	2
RICHARDSON-EASTMAN RETRACTOR FIG.1+2	178	SCALPEL HANDLE NO.4	3
RICHARDSON-EASTMAN RETRACTOR FIG.2 28	178	SCALPEL HANDLE NO.4 L	3
RICHTER OPERATING SCISS. BL/BL 14.5 CM	32	SCALPEL HANDLE NO.7	2
RICHTER RETRACTOR 17 CM	196	SCALPEL HANDLE NO.7K	2
RICHTER-HEATH CLIP FORCEPS 14.0 CM	154	SCALPEL HANDLE, HOLLOW, NO.8	3
ROBERTS ARTERY FORCEPS CURVED 22,0 CM	107	SCALPEL HANDLE, HOLLOW, NO.9	3
ROBERTS ARTERY FORCEPS STRAIGHT 22,0 CM	107	SCALPEL HANDLE, NO.3	2
ROBIN-MASSE ABDOMINAL RETRACTOR	199	SCHAEDEL TOWEL FORCEPS 9.0 CM	86
ROBIN-MASSE, ABDOMINAL RETRACTOR, VALVE	200	SCHAMBERG, COMEDO EXTRACTOR, 10,0 CM	295
ROBIN-MASSE, ABDOMINAL RETRACTOR, VALVE	200	SCHEDÉ, BONE CURETTE, FIG.0, 17,0 CM	298
ROBIN-MASSE, ABDOMINAL RETRACTOR, VALVE	200	SCHEDÉ, BONE CURETTE, FIG.00, 17,0 CM	298

SCHEDE, BONE CURETTE, FIG.000, 17,0 CM	298	SIMON UTERINE SCOOP,FIG.6,25CM	286
SCHEDE, BONE CURETTE, FIG.1, 17,0 CM	298	SIMON, RETRACTOR, 115 x 22 MM, 28,0 CM	180
SCHEDE, BONE CURETTE, FIG.2, 17,0 CM	298	SIMON, RETRACTOR, 115 x 27 MM, 28,0 CM	180
SCHEDE, BONE CURETTE, FIG.3, 17,0 CM	298	SIMPSON, OBSTETRICAL FORCEPS, 30,0 CM	289
SCHEDE, BONE CURETTE, FIG.4, 17,0 CM	298	SIMPSON, UTERINE PROBE, MALLEABLE, 29,0	277
SCHERBAK VAGINAL SPECULA	261	SIMPSON-BRAUN, OBSTETRICAL FORCEPS 33 CM	289
SCHERBAK VAGINAL SPECULA,SET COMPLETE	261	SIMPSON-BRAUN, OBSTETRICAL FORCEPS,	289
SCHERBAK, VAGINAL SPECULA	261	SIMPSON-LUIKART, OBSTETRICAL FORCEPS	289
SCHERBAK, VAGINAL SPECULA	261	SIMS GYNEC. SCISSORS CVD BL/BL 23.0 CM	40
SCHERBAK, VAGINAL SPECULA	261	SIMS GYNEC. SCISSORS CVD SH/BL 20.0 CM	40
SCHERBAK, VAGINAL SPECULA	261	SIMS GYNEC.SCISSORS CVD SH/BL 23.0 CM	40
SCHERBAK, VAGINAL SPECULA	261	SIMS GYNEC.SCISSORS CVD SH/SH 23.0 CM	40
SCHERBAK, VAGINAL SPECULA	261	SIMS GYNEC.SCISSORS STR BL/BL 20.0 CM	39
SCHERBAK, VAGINAL SPECULA,	261	SIMS GYNEC.SCISSORS STR BL/BL 23.0 CM	39
SCHINK, DERMATOME, SPARE BLADES ONLY	11	SIMS GYNEC.SCISSORS STR BL/BL 23.0 CM	39
SCHINK, DERMATOME, 30,0 CM	11	SIMS GYNEC.SCISSORS STR SH/BL 20.0 CM	39
SCHINK, DERMATOMES, SKIN STRAIGHTENING	10	SIMS GYNEC.SCISSORS STR SH/BL 23.0 CM	39
SCHMID NEEDLE 15,0 CM 3MM	224	SIMS GYNEC.SCISSORS STR SH/SH 20.0 CM	39
SCHMID NEEDLE 15.0 CM 4 MM	224	SIMS RECTAL SPECULA FENESTRATED 15,0 CM	252
SCHMID NEEDLE 15.0 CM 5 MM	224	SIMS RECTAL SPECULA FULL BLADES 15,0 CM	252
SCHMID NEEDLE 15.0 CM 6 MM	224	SIMS SCISSORS CVD BL/BL 20.0 CM	40
SCHMIEDEN LIGATURE CONDUCTOR 19,0 CM	152	SIMS SCISSORS CVD SH/SH 20.0 CM	40
SCHMIEDEN LIGATURE NEEDLE 21.0 CM	148	SIMS UTERINE CURETTE, SHARP	283
SCHMIEDEN-PAYR LIGATURE CONDUCTOR	152	SIMS UTERINE CURETTE, SHARP	283
SCHMIEDEN-TAYLOR DURA SCISSORS 17.0 CM	35	SIMS UTERINE PROBE MALLEABLECM"32.0 CM"	277
SCHNIDT ARTERY FORCEPS CVD, 19,0 CM	104	SIMS UTERINE PROBE RIGID CM 32.0 CM	277
SCHNIDT ARTERY FORCEPS CVD, 19,0 CM	104	SIMS VAG.SPECULUM DOUBLE 60X25+30 MM	267
SCHNIDT-SAWTELL ARTERY FORCEPS CVD, 19,0 CM	103	SIMS VAG.SPECULUM DOUBLE 70X30+35 MM	267
SCHNIDT-SAWTELL ARTERY FORCEPS CVD, 19,0 CM	104	SIMS VAG.SPECULUM DOUBLE 80X35+40 MM	267
SCHROEDER FCPS CVD 24.0 CM, 2X2 24 CM	274	SIMS, GYN.- SCISSORS TC, STRAIGHT,	52
SCHROEDER FORCEPS BOX LOCK, 25,0 CM	273	SIMS, GYN.- SCISSORS TC, STRAIGHT,	52
SCHROEDER VULSELLUM FCPS STR 2X2T	274	SIMS, GYN.-SCISSORS TC, CURVED, BL/BL,	52
SCHUBERT, CERV.BIOPSY+SPEC.FCPS 26 CM	287	SIMS, GYN.-SCISSORS TC, CURVED, BL/BL,	52
SCHUBERT, CERVICAL BIOPSY FORCEPS,	286	SIMS, GYN.-SCISSORS TC, CURVED, SH/BL,	52
SCHUBERT, CERVICAL BIOPSY FORCEPS, 29	286	SIMS, GYN.-SCISSORS TC, CURVED, SH/BL,	52
SCHUHKNECHT, SELF-RETAINING RETRACTOR,	190	SIMS, GYN.-SCISSORS TC, CURVED, SH/SH,	52
SCHUHKNECHT, SELF-RETAINING RETRACTOR,	190	SIMS, GYN.-SCISSORS TC, CURVED, SH/SH,	52
SCHUMACHER CERVICAL BIOPSY+SPEC.FCPS 4MM	287	SIMS, GYN.-SCISSORS TC, STRAIGHT,	52
SCHUMACHER CERVICAL BIOPSY+SPEC.FCPS 6MM	287	SIMS, GYN.-SCISSORS TC, STRAIGHT,	52
SCHUMACHER UMBILICAL SCISSORS 16.0 CM	43	SIMS, GYN.-SCISSORS TC, STRAIGHT,	52
SCHUMACHER-VAN DOREN FCPS FIG.1	286	SIMS, GYN.-SCISSORS TC, STRAIGHT,	52
SCUDDER INTEST.CLAMP FCPS. CVD. 33,0 CM	250	SIMS, UTERINE CURETTE, BLUNT,	281
SCUDDER INTEST.CLAMP FCPS. STR. 33,0 CM	250	SIMS, UTERINE CURETTE, BLUNT,	281
SEDILLOT, RASPARTORY	303	SIMS, UTERINE CURETTE, BLUNT,	281
SEGOND MYOMA KNIFE, 27.0CM	279	SIMS, UTERINE CURETTE, BLUNT,	281
SELDINGER-STILLE, BIOPSY-CANNULA, Ø 1,6	225	SIMS, UTERINE CURETTE, BLUNT,	281
SELDINGER-STILLE, BIOPSY-CANNULA, Ø 2,0	225	SIMS, UTERINE CURETTE, BLUNT,	281
SEMB BRONCHUS CLAMPS 22,0 CM	118	SIMS, UTERINE CURETTE, BLUNT,	281
SEMB BRONCHUS CLAMPS 22,0 CM	118	SIMS, UTERINE CURETTE, BLUNT,	281
SEMKEN TISSUE FCPS STR 1X2 TEETH 12.5CM	73	SIMS, UTERINE CURETTE, BLUNT,	281
SEMKEN TISSUE FCPS STR 2X3 TEETH 12,0cm	73	SIMS, UTERINE CURETTE, BLUNT,	281
SEMKEN, DRESSING FORCEPS STRAIGHT	67	SIMS, UTERINE CURETTE, BLUNT,	281
SEMKEN, DRESSING FORCEPS STRAIGHT	67	SIMS, UTERINE CURETTE, BLUNT,	281
SEMKEN, TISSUE FCPS, 1X2 TEETH, TC,	82	SIMS, UTERINE CURETTE, BLUNT,	281
SEMKEN, TISSUE FCPS, 1X2 TEETH, TC,	82	SIMS, UTERINE CURETTE, BLUNT,	281
SEMKEN, TISSUE FORCEPS,	73	SIMS, UTERINE CURETTE, BLUNT,	283
SEMM VAGINAL SPECULA 100X17/20MM	260	SIMS, UTERINE CURETTE, BLUNT, RIGID,	281
SEMM VAGINAL SPECULA 100X25/30MM	260	SIMS, UTERINE CURETTE, BLUNT, RIGID,	281
SEMM VAGINAL SPECULA 90X14/18MM	260	SIMS, UTERINE CURETTE, BLUNT, RIGID,	281
SEMM, ABDOMINAL RETRACTOR, COMPLETE	208	SIMS, UTERINE CURETTE, BLUNT, RIGID,	281
SEMM, ABDOMINAL RETRACTOR, FRAME ONLY,	208	SIMS, UTERINE CURETTE, BLUNT, RIGID,	281
SEMM, ABDOMINAL RETRACTOR, VALVE ONLY,	208	SIMS, UTERINE CURETTE, BLUNT, RIGID,	281
SEMM, ABDOMINAL RETRACTOR, VALVE ONLY,	208	SIMS, UTERINE CURETTE, BLUNT, RIGID,	281
SEMM, ABDOMINAL RETRACTOR, VALVE ONLY,	208	SIMS, UTERINE CURETTE, BLUNT, RIGID,	281
SEMM, ABDOMINAL RETRACTOR, VALVE ONLY,	208	SIMS, UTERINE CURETTE, BLUNT, RIGID,	281
SEMM, ABDOMINAL RETRACTOR, VALVE ONLY,	208	SIMS, UTERINE CURETTE, BLUNT, RIGID,	281
SENN-GREEN RETRACTOR 10X6 MM 15.0 CM	162	SIMS, UTERINE CURETTE, BLUNT, RIGID,	281
SENN-GREEN RETRACTOR 20X6 MM 15.0 CM	162	SIMS, UTERINE CURETTE, BLUNT, RIGID,	281
SENN-MILLER RETRACTOR BLOUNT 16.0 CM	163	SIMS, UTERINE CURETTE, BLUNT, RIGID,	281
SENN-MILLER RETRACTOR SHARP 16.0 CM	163	SIMS, UTERINE CURETTE, BLUNT, RIGID,	281
SETTING FORCEPS F.BULLDOG CLAMPS 23.0	94	SIMS, UTERINE CURETTE, SHARP	283
SIEBOLD GYNEC.SCS S-CURVED BL/BL 24.0	40	SIMS, UTERINE CURETTE, SHARP	283
SILVER, DERMATOMES, 19.0 CM	11	SIMS, UTERINE CURETTE, SHARP	283
SILVER, DERMATOMES, SPARE BLADES ONLY	11	SIMS, UTERINE CURETTE, SHARP	283
SIMON FISTULA HOOK 2 PRONGS 22.0 CM	279	SIMS, UTERINE CURETTE, SHARP	283
SIMON UTERINE SCOOP,FIG.1, 25CM	286	SIMS, UTERINE CURETTE, SHARP	283
SIMON UTERINE SCOOP,FIG.2, 25CM	286	SIMS, UTERINE CURETTE, SHARP	283
SIMON UTERINE SCOOP,FIG.3,25CM	286	SIMS, UTERINE CURETTE, SHARP	283
SIMON UTERINE SCOOP,FIG.4,25CM	286	SIMS, UTERINE CURETTE, SHARP	283
SIMON UTERINE SCOOP,FIG.5,25CM	286	SIMS, UTERINE CURETTE, SHARP	283

Alfabetisches Inhaltsverzeichnis
Alphabetical Index

SIMS, UTERINE CURETTE, SHARP	283	SPLINTER FCPS CVD SERRAT.13.0 CM	77
SIMS, UTERINE CURETTE, SHARP	283	SPLINTER FCPS CVD SERRAT.14.5 CM	77
SIMS, UTERINE CURETTE, SHARP	283	SPLINTER FCPS CVD SERRAT.8.0 CM	77
SIMS, UTERINE CURETTE, SHARP	283	SPLINTER FCPS WITH PIN SERRAT CVD 8.0	77
SIMS, UTERINE CURETTE, SHARP	283	SPLINTER FCPS WITH PIN SERRAT CVD 9.0	77
SIMS, UTERINE CURETTE, SHARP	283	SPLINTER FCPS WITH PIN SERRAT CVD10.5	77
SIMS, UTERINE CURETTE, SHARP	283	SPLINTER FCPS WITH PIN SERRAT CVD11.5	77
SIMS, UTERINE CURETTE, SHARP	283	SPLINTER FCPS WITH PIN SERRAT CVD13.0	77
SIMS, UTERINE CURETTE, SHARP	283	SPLINTER FCPS WITH PIN SERRAT CVD14.5	77
SIMS, UTERINE CURETTE, SHARP	283	SPLINTER FCPS WITH PIN SERRAT STR 8.5	77
SIMS, UTERINE CURETTE, SHARP	283	SPLINTER FCPS WITH PIN SERRAT STR 9.0	77
SIMS, UTERINE CURETTE, SHARP	283	SPLINTER FCPS WITH PIN SERRAT STR10.5	77
SIMS, UTERINE CURETTE, SHARP	283	SPLINTER FCPS WITH PIN SERRAT STR11.5	77
SIMS, UTERINE CURETTE, SHARP	283	SPLINTER FCPS WITH PIN SERRAT STR13.0	77
SIMS, UTERINE CURETTE, SHARP	283	SPLINTER FCPS WITH PIN SERRAT STR14.5	77
SIMS, UTERINE CURETTE, SHARP	284	SPLINTER FCPS. SERRAT STR 10.5CM	77
SIMS, UTERINE CURETTE, SHARP	284	SPLINTER FCPS. SERRAT STR 11.5 CM	77
SIMS, UTERINE CURETTE, SHARP	284	SPLINTER FCPS. SERRAT STR 13.0CM	77
SIMS, UTERINE CURETTE, SHARP	284	SPLINTER FCPS. SERRAT STR 14.5 CM	77
SIMS, UTERINE CURETTE, SHARP,	280	SPLINTER FCPS. SERRAT STR 8.0 CM	77
SIMS, VAGINAL SPECULA, DOUBLE, SET W. 3	267	SPLINTER FCPS. SERRAT STR 9.0 CM	77
SINGLEY-TUTTLE GRASPING FORCEPS 23,0 CM	68	SPLINTER FORCEPS, ANGLED, 10.0 CM	78
SKENE, UTERINE TENACULUM FORCEPS, 24 CM	274	SPLINTER FORCEPS, STRAIGHT, 10.0 CM	78
SMITH (MOD.USA)BANDAGE SCISSORS 16.0 CM	45	ST.MARKS, RETRACTOR, FIG.1, 29.0 CM	186
SMITH (MOD.USA)BANDAGE SCISSORS 18.0 CM	45	ST.MARKS, RETRACTOR, FIG.2, 33 CM	186
SMITH (MOD.USA)BANDAGE SCISSORS 20.0 CM	45	ST.MARKS, RETRACTOR, FIG.3, 29.0 CM	186
SMITH (MOD.USA)BANDAGE SCISSORS 23.0 CM	45	ST.MARKS, RETRACTOR, FIG.4, 33 CM	186
SMITH-BUIE ANAL RETRACTOR 75X23MM	252	STACKE EAR PROBE 1 MM DIAMETER 10.5 CM	214
SMITH-PETERSEN GOUGE CURVED 14MM	306	STANDARD DRESSING FORCEPS STR 10.5 CM	64
SMITH-PETERSEN GOUGE CURVED 16MM	306	STANDARD DRESSING FORCEPS STR 11.5 CM	64
SMITH-PETERSEN GOUGE CURVED 19MM	306	STANDARD DRESSING FORCEPS STR 13.0 CM	64
SMITH-PETERSEN GOUGE CURVED 25MM	306	STANDARD DRESSING FORCEPS STR 14.5 CM	64
SMITH-PETERSEN GOUGE CURVED 9MM	306	STANDARD DRESSING FORCEPS STR 15.0 CM	64
SMITH-PETERSEN GOUGE STRAIGHT 14MM	306	STANDARD DRESSING FORCEPS STR 16.0 CM	64
SMITH-PETERSEN GOUGE STRAIGHT 16MM	306	STANDARD DRESSING FORCEPS STR 18.0 CM	64
SMITH-PETERSEN GOUGE STRAIGHT 19MM	306	STANDARD DRESSING FORCEPS STR 20.0 CM	64
SMITH-PETERSEN GOUGE STRAIGHT 25MM	306	STANDARD DRESSING FORCEPS STR 25.0 CM	64
SMITH-PETERSEN GOUGE STRAIGHT 9MM	306	STANDARD DRESSING FORCEPS STR 30.0 CM	64
SMITH-PETERSEN OSTEOTOME 13MM 20 CM	305	STANDARD OPER.SCS CVD SH/BL 10.5 CM	14
SMITH-PETERSEN OSTEOTOME 13MM 20 CM	305	STANDARD OPER.SCS CVD SH/BL 13.0 CM	14
SMITH-PETERSEN OSTEOTOME 16MM 20 CM	305	STANDARD OPER.SCS CVD SH/BL 17.5 CM	14
SMITH-PETERSEN OSTEOTOME 16MM 20 CM	305	STANDARD OPER.SCS STR. BL/BL 17.5 CM	14
SMITH-PETERSEN OSTEOTOME 19MM 20 CM	305	STANDARD OPER.SCS. CVD BL/BL 10.5 CM	14
SMITH-PETERSEN OSTEOTOME 19MM 20 CM	305	STANDARD OPER.SCS. CVD BL/BL 11.5 CM	14
SMITH-PETERSEN OSTEOTOME 25MM 20 CM	305	STANDARD OPER.SCS. CVD BL/BL 17.5 CM	14
SMITH-PETERSEN OSTEOTOME 25MM 20 CM	305	STANDARD OPER.SCS. CVD SH/SH 10.5 CM	15
SMITH-PETERSEN OSTEOTOME 32MM 20 CM	305	STANDARD OPER.SCS. CVD SH/SH 17.5 CM	15
SMITH-PETERSEN OSTEOTOME 32MM 20 CM	305	STANDARD OPER.SCS. CVD SH/SH 18.5 CM	15
SMITH-PETERSEN OSTEOTOME 6MM 20 CM	305	STANDARD OPER.SCS. CVD SH/SH 20.0 CM	15
SMITH-PETERSEN OSTEOTOME 6MM 20 CM	305	STANDARD OPER.SCS. CVD.BL/BL 13.0 CM	14
SMITH-PETERSEN OSTEOTOME 9MM 20 CM	305	STANDARD OPER.SCS. CVD.BL/BL 14.5 CM	14
SMITH-PETERSEN OSTEOTOME 9MM 20 CM	305	STANDARD OPER.SCS. CVD.BL/BL 15.5 CM	14
SÖKELAND, GALL STONE FORCEPS, 24,0 CM	233	STANDARD OPER.SCS. CVD.BL/BL 16.5 CM	14
SOLUTION BOWL 165 x 60 MM	309	STANDARD OPER.SCS. CVD.BL/BL 18.5 CM	14
SOLUTION BOWL 175 x 70 MM	309	STANDARD OPER.SCS. CVD.BL/BL 20.0 CM	14
SOLUTION BOWL 220 x 80 MM	309	STANDARD OPER.SCS. CVD.SH/BL 11.5 CM	14
SOLUTION BOWL 225 x 90 MM	309	STANDARD OPER.SCS. CVD.SH/BL 14.5 CM	14
SOLUTION BOWL 240 x 110 MM	309	STANDARD OPER.SCS. CVD.SH/BL 15.5 CM	14
SOLUTION BOWL 275 x 115 mm	309	STANDARD OPER.SCS. CVD.SH/BL 16.5 CM	14
SOLUTION BOWL 290 x 125 mm	309	STANDARD OPER.SCS. CVD.SH/BL 18.5 CM	14
SOLUTION BOWL 310 x 120mm	309	STANDARD OPER.SCS. CVD.SH/BL 20.0 CM	14
SOLUTION BOWL 360 x 165 MM 12,0 L	309	STANDARD OPER.SCS. CVD.SH/SH 10.5 CM	15
SOLUTION BOWL 415 x 150 MM 14,0 L	309	STANDARD OPER.SCS. CVD.SH/SH 13.0 CM	15
SOLUTION BOWL SMALL 25CCM	310	STANDARD OPER.SCS. CVD.SH/SH 14.5 CM	15
SOLUTION BOWL SMALL 50CCM	310	STANDARD OPER.SCS. CVD.SH/SH 15.5 CM	15
SOMER, UTERINE ELEVATING FORCEPS,	276	STANDARD OPER.SCS. CVD.SH/SH 16.5 CM	15
SPENCER, LIGATURE SCISSORS, 10.5 CM	33	STANDARD OPER.SCS. STR BL/BL 20.0 CM	14
SPENCER, LIGATURE SCISSORS, 9.0 CM	33	STANDARD OPER.SCS. STR SH/BL 17.5 CM	14
SPENCER, LIGATURE SCISSORS,12.5 CM	33	STANDARD OPER.SCS. STR SH/SH 10.5 CM	15
SPENCER-WELLS, ART.FCPS.CVD 13.0 CM	99	STANDARD OPER.SCS. STR SH/SH 17.5 CM	15
SPENCER-WELLS, ART.FCPS.CVD 15.5 CM	99	STANDARD OPER.SCS. STR SH/SH 18.5 CM	15
SPENCER-WELLS, ART.FCPS.STR 13.0 CM	99	STANDARD OPER.SCS. STR SH/SH 20.0 CM	15
SPENCER-WELLS, ART.FCPS.STR 15.5 CM	99	STANDARD OPER.SCS. STR.BL/BL 18.5 CM	14
SPENCER-WELLS, ARTERY FCPS CVD 20.0 CM	99	STANDARD OPER.SCS. STR.BL/BL 10.5 CM	14
SPENCER-WELLS, ARTERY FCPS STR 20.0 CM	99	STANDARD OPER.SCS. STR.BL/BL 13.0 CM	14
SPENCER-WELLS, ARTERY FCPS. STR 18.0 CM	99	STANDARD OPER.SCS. STR.BL/BL 14.5 CM	14
SPENCER-WELLS, ARTERY FORCEPS	99	STANDARD OPER.SCS. STR.BL/BL 15.5 CM	14
SPLINTER FCPS CVD SERRAT 9.0 CM	77	STANDARD OPER.SCS. STR.BL/BL 16.5 CM	14
SPLINTER FCPS CVD SERRAT.10.5 CM	77	STANDARD OPER.SCS. STR.SH/BL 10.5 CM	14
SPLINTER FCPS CVD SERRAT.11.5 CM	77	STANDARD OPER.SCS. STR.SH/BL 11.5 CM	14

STANDARD OPER.SCS. STR.SH/BL 13.0 CM	14	STEVENS, TENOTOMY SCS., SC, CRV.	57
STANDARD OPER.SCS. STR.SH/BL 14.5 CM	14	STEVENS, TENOTOMY SCS., SC, STRAIGHT	57
STANDARD OPER.SCS. STR.SH/BL 15.5 CM	14	STILLE DRESSING FORCEPS 15,0 CM	66
STANDARD OPER.SCS. STR.SH/BL 16.5 CM	14	STILLE KIDNEY PED.CLAMP FCPS 23.0 CM	116
STANDARD OPER.SCS. STR.SH/BL 18.5 CM	14	STILLE TISSUE FCPS 2X3 TEETH STR 15.0	72
STANDARD OPER.SCS. STR.SH/BL 20.0 CM	14	STILLE TISSUE FCPS STR 1X2 TEETH 15.0	72
STANDARD OPER.SCS. STR.SH/SH 11.5 CM	15	STILLE, CHISEL	305
STANDARD OPER.SCS. STR.SH/SH 13.0 CM	15	STILLE, CHISEL	305
STANDARD OPER.SCS. STR.SH/SH 14.5 CM	15	STILLE, CHISEL	305
STANDARD OPER.SCS. STR.SH/SH 15.5 CM	15	STILLE, CHISEL	305
STANDARD OPER.SCS. STR.SH/SH 16.5 CM	15	STILLE, GOUGE	305
STANDARD SCS TC CVD BL/BL 14.5 CM	46	STILLE, GOUGE	305
STANDARD SCS TC CVD BL/BL 16.5 CM	46	STILLE, GOUGE	305
STANDARD SCS TC CVD BL/BL 18.5 CM	46	STILLE, GOUGE STRAIGHT 15 mm 20 cm	305
STANDARD SCS TC CVD SH/BL 14.5 CM	46	STILLE, OSTEOTOME	304
STANDARD SCS TC CVD SH/BL 16.5 CM	46	STILLE, OSTEOTOME	304
STANDARD SCS TC CVD SH/BL 18.5 CM	46	STILLE, OSTEOTOME	304
STANDARD SCS TC CVD SH/SH 14.5 CM	46	STILLE, OSTEOTOME,	304
STANDARD SCS TC CVD SH/SH 16.5 CM	46	STOCKMANN MEATUS CLAMP W/O CATCH 8 CM	240
STANDARD SCS TC CVD SH/SH 18.5 CM	46	STOPCOCK, 1 X LUER-LOCK MALE	229
STANDARD SCS TC STR BL/BL 16.5 CM	46	STOPCOCK, LUER-LOCK,	229
STANDARD SCS TC STR BL/BL 18.5 CM	46	STOPCOCK, LUER-LOCK, FEMALE	229
STANDARD SCS TC STR SH/BL 14.5 CM	46	STRABISMUS SCISSORS CVD BL. 11.5 CM SC	57
STANDARD SCS TC STR SH/BL 16.5 CM	46	STRABISMUS SCISSORS CVD BLUNT 11.5 CM	28
STANDARD SCS TC STR SH/BL 18.5 CM	46	STRABISMUS SCISSORS STR BL. 11,5CM SC	57
STANDARD SCS TC STR SH/SH 14.5 CM	46	STRABISMUS SCISSORS STR BLUNT 11.5 CM	28
STANDARD SCS TC STR SH/SH 16.5 CM	46	STRATTE NEEDLE HOLDER 23.0 CM	128
STANDARD SCS TC STR SH/SH 18.5 CM	46	STRATTE NEEDLE HOLDER TC CVD 22.0 CM	140
STANDARD TISSUE FCPS., WITH PIN, 1X2 T	70	STRATTE NEEDLE HOLDER TC CVD 23.0 CM	140
STANDARD TISSUE FCPS., WITH PIN, 1X2 T	70	STRAUSS MEATUS CLAMP WITH RUBBER	240
STANDARD TISSUE FCPS., WITH PIN, 1X2 T	70	STRULLY NEUROSURGICAL SCS CVD 22.0 CM	34
STANDARD TISSUE FCPS., WITH PIN, 1X2 T	70	SURGICAL SCISSORS, STANDARD TC	46
STANDARD TISSUE FCPS., WITH PIN, 1X2 T	70	SYRINGE, LUER, 1 ML	227
STANDARD TISSUE FCPS., WITH PIN, 1X2 T	70	SYRINGE, LUER, 10 ML	227
STANDARD TISSUE FCPS., WITH PIN, 1X2 T	70	SYRINGE, LUER, 2 ML	227
STANDARD TISSUE FCPS., WITH PIN, 1X2 T	70	SYRINGE, LUER, 20 ML	227
STANDARD TROCER, W. SHIELD A. STOPCOCK,	218	SYRINGE, LUER, 5 ML	227
STANDARD TROCER, W. SHIELD A. STOPCOCK,	218	SYRINGE, LUER, 50 ML	227
STANDARD TROCER, W. SHIELD A. STOPCOCK,	218	SYRINGE, LUER-LOCK, 1 ML	227
STANDARD TROCER, W. SHIELD A. STOPCOCK,	218	SYRINGE, LUER-LOCK, 10 ML	227
STANDARD TROCER, W. SHIELD A. STOPCOCK,	218	SYRINGE, LUER-LOCK, 10 ML	228
STANDARD TROCER, W. SHIELD A. STOPCOCK,	218	SYRINGE, LUER-LOCK, 2 ML	227
STANDARD TROCER, W. SHIELD A. STOPCOCK,	218	SYRINGE, LUER-LOCK, 20 ML	227
STANDARD TROCER, W. SHIELD, Ø 3,0 MM,	218	SYRINGE, LUER-LOCK, 20 ML	228
STANDARD TROCER, W. SHIELD, Ø 3,5 MM,	218	SYRINGE, LUER-LOCK, 30 ML	228
STANDARD TROCER, W. SHIELD, Ø 4,0 MM,	218	SYRINGE, LUER-LOCK, 5 ML	227
STANDARD TROCER, W. SHIELD, Ø 4,5 MM,	218	SYRINGE, LUER-LOCK, 50 ML	227
STANDARD TROCER, W. SHIELD, Ø 5,0 MM,	218	SYRINGE, LUER-LOCK, 50 ML	228
STANDARD TROCER, W. SHIELD, Ø 5,5 MM,	218	SYRINGE, THREERING-, LUER-LOCK, 10 ML	227
STANDARD TROCER, W. SHIELD, Ø 6,0 MM,	218	SYRINGE, THREERING-, LUER-LOCK, 2 ML	227
STANDARD TROCER, W. SHIELD, STOPCOCK	218	SYRINGE, THREERING-, LUER-LOCK, 5 ML	227
STANDARD TROCER, W. SHIELD, STOPCOCK	218	TAYLOR DRESSING FCPS BAY-SHAPED 18.5 CM	66
STANDARD TROCER, W. SHIELD, STOPCOCK	218	TAYLOR DRESSING FORCEPS CVD 17.5 CM	66
STANDARD TROCER, W. SHIELD, STOPCOCK	218	TAYLOR DRESSING FORCEPS STR 17.5 CM	66
STANDARD TROCER, W. SHIELD, STOPCOCK	218	TAYLOR TISSUE FCPS BAY-SHAPED 17.5 CM	73
STANDARD TROCER, W. SHIELD, STOPCOCK	218	TAYLOR TISSUE FCPS CVD 1X2 TEETH 17.5	73
STANDARD TROCER, W. SHIELD, STOPCOCK	218	TAYLOR TISSUE FCPS STR 1X2 TEETH 17.5	73
STAUDE-MOORE, UTERINE TENACULUM	272	TEALE FCPS CVD 3X4 T. 23.0 CM	274
STELZNER, LOBECTOMY AND RECTAL SCS.,	42	TENOTOMY SCISSORS CVD BLUNT 11.5 CM	31
STELZNER, LOBECTOMY AND RECTAL SCS.,	42	TERRIER, ARTERY FORCEPS	98
STERILIZING FORCEPS, 20,0 CM	308	THOMS-ALLIS INT.TISSUE FCPS. 6X7 20,0 CM	243
STEVENS TENOTOM.SCS BLUNT CVD 10.5 CM	31	THOMS-GAYLOR, CERVICAL BIOPSY FORCEPS,	286
STEVENS TENOTOM.SCS BLUNT STR 10.5 CM	31	THOMS-GAYLOR, CERVICAL BIOPSY FORCEPS,	286
STEVENS TENOTOM.SCS POINTED CVD 10.5 CM	31	THOMS-GAYLOR, CERVICAL BIOPSY FORCEPS,	287
STEVENS TENOTOM.SCS POINTED STR 10.5 CM	31	THOMSON-WALKER, BLADDER RETRACTOR	237
STEVENS TENOTOM.SCS.CVD POINTED 11.5 CM	31	THOREK, DISSECTING SCISSORS,	27
STEVENS TENOTOM.SCS.STR BLUNT 11.5 CM	31	THOREK, DISSECTING SCISSORS,	27
STEVENS TENOTOM.SCS.STR POINTED 11.5CM	31	THREE-WAY-STOPCOCK, 3 X LUER-LOCK FEMALE	229
STEVENS, MICRO-SCISSORS, BAJ. SH/SH	59	TISCHLER-KEVORKIAN, CERVICAL BIOPSY	288
STEVENS, MICRO-SCISSORS, BAJ. SH/SH	59	TISCHLER-MORGAN, CERVICAL BIOPSY AND	288
STEVENS, MICRO-SCISSORS, BAJ., SH/SH	59	TISSUE FCPS., DELICATE, CURVED, WITH	70
STEVENS, MICRO-SCISSORS, BAJ., SH/SH	59	TISSUE FCPS., DELICATE, CURVED, WITH	70
STEVENS, MICRO-SCISSORS, BAJ., SH/SH	59	TISSUE FCPS., DELICATE, CURVED, WITH	70
STEVENS, MICRO-SCISSORS, BAJ., SH/SH	59	TISSUE FCPS., DELICATE, CURVED, WITH	70
STEVENS, MICRO-SCISSORS, BAJ., SH/SH	59	TISSUE FCPS., DELICATE, CURVED, WITH	70
STEVENS, MICRO-SCISSORS, BAJ., SH/SH	59	TISSUE FORCEPS 2X3 TEETH STR 11.5 CM	69
STEVENS, MICRO-SCISSORS, BAJ., SH/SH	59	TISSUE FORCEPS 2X3 TEETH STR 13.0 CM	69
STEVENS, MICRO-SCISSORS, BAJ., SH/SH	59	TISSUE FORCEPS 2X3 TEETH STR 14.5 CM	69
STEVENS, MICRO-SCISSORS, BAJONETT	59	TISSUE FORCEPS 2X3 TEETH STR 16.0 CM	69
STEVENS, MICRO-SCISSORS, BAJONETT	59	TISSUE FORCEPS 2X3 TEETH STR 18.0 CM	69

Alfabetisches Inhaltsverzeichnis
Alphabetical Index

TISSUE FORCEPS 2X3 TEETH STR 20.0 CM	69	TURNER-WARWICK MODIF., ABDOMINAL	203
TISSUE FORCEPS 2X3 TEETH STR 25.0 CM	69	TURNER-WARWICK MODIF., ABDOMINAL	203
TISSUE FORCEPS 2X3 TEETH STR 30.0 CM	69	TURNER-WARWICK MODIF., ABDOMINAL	203
TISSUE FORCEPS 3X4 TEETH STR 13.0 CM	69	TURNER-WARWICK MODIF., ABDOMINAL	204
TISSUE FORCEPS 3X4 TEETH STR 14,5 CM	69	TURNER-WARWICK MODIF., ABDOMINAL	204
TISSUE FORCEPS 3X4 TEETH STR 16.0 CM	69	TURNER-WARWICK MODIF., ABDOMINAL	204
TISSUE FORCEPS 3X4 TEETH STR 18.0 CM	69	TURNER-WARWICK MODIF., ABDOMINAL	204
TISSUE FORCEPS 3X4 TEETH STR 20.0 CM	69	TURNER-WARWICK MODIF., ABDOMINAL	204
TISSUE FORCEPS 4X5 TEETH STR 13.0 CM	69	TURNER-WARWICK MODIF., ABDOMINAL	204
TISSUE FORCEPS 4X5 TEETH STR 14.5 CM	69	TURNER-WARWICK MODIF., ABDOMINAL	204
TISSUE FORCEPS 4X5 TEETH STR 16.0 CM	69	TURNER-WARWICK MODIF., ABDOMINAL	204
TISSUE FORCEPS 4X5 TEETH STR 18.0 CM	69	TURNER-WARWICK MODIF., ABDOMINAL	204
TISSUE FORCEPS 4X5 TEETH STR 20.0 CM	69	TURNER-WARWICK, GALL STONE FORCEPS,	233
TISSUE FORCEPS NARROW 1X2 TEETH 14,5 CM	70	TURNER-WARWICK, GALL STONE FORCEPS,	233
TISSUE FORCEPS NARROW 1X2 TEETH 15,5 CM	70	UCKERMANN COTTON APPLICATOR 16 CM	216
TISSUE FORCEPS NARROW 1X2 TEETH 16.0 CM	70	ULRICH POLYPUS FORCEPS CURVED 22.0 CM	89
TISSUE FORCEPS NARROW 1X2 TEETH 18.0 CM	70	ULRICH POLYPUS FORCEPS CURVED 25.0 CM	89
TISSUE FORCEPS NARROW 1X2 TEETH 20.0 CM	70	ULRICH POLYPUS FORCEPS CURVED 27.0 CM	89
TISSUE FORCEPS NARROW 1X2 TEETH 25.0 CM	70	ULRICH POLYPUS FORCEPS STRAIGHT 22.0 CM	89
TISSUE FORCEPS NARROW 1X2 TEETH 30.0 CM	70	ULRICH POLYPUS FORCEPS STRAIGHT 25.0 CM	89
TISSUE FORCEPS, ENGL. PATTERN, 1X2 T	70	ULRICH POLYPUS FORCEPS STRAIGHT 27.0 CM	89
TISSUE FORCEPS, ENGL. PATTERN, 1X2 T	70	UNIVERSAL BANDAGE SCISSORS 14.0 CM	45
TISSUE FORCEPS, ENGL. PATTERN, 1X2 T	70	UNIVERSAL BANDAGE SCISSORS 16.0 CM	45
TISSUE FORCEPS, NARROW	70	UNIVERSAL BANDAGE SCISSORS 18.0 CM	45
TISSUE FORCEPS, STANDARD,	69	UNIVERSAL TROCARS SET OF 3 FLAT HDL.	218
TISSUE FORCEPS, STANDARD,	69	UNIVERSAL TROCARS SET OF 4 FLAT HDL.	218
TISSUE FORCEPS, STANDARD,	69	UNIVERSAL TROCARS, SET OF 3 PCS., ROUND	219
TISSUE FORCEPS, STANDARD, 1X2 T STR	69	UNIVERSAL TROCARS, SET OF 4 PCS., ROUND	219
TISSUE FORCEPS, STANDARD, 1X2 T STR	69	UNIVERSAL WIRE SCISSORS SAW EDGE 12.0	44
TISSUE FORCEPS, STANDARD, 1X2 T STR	69	UNIVERSAL WIRE SHEARS TC 12.0 CM	55
TISSUE FORCEPS, STANDARD, 1X2 T STR	69	UNNA, COMEDO EXTRACTOR,	295
TISSUE FORCEPS, STANDARD, 1X2 T STR	69	UNNA, COMEDO EXTRACTOR,	295
TISSUE FORCEPS, STANDARD, 1X2 T STR	69	URO-TANGENTIAL FORCEPS 26CM	117
TISSUE FORCEPS, STANDARD, 1X2 T STR	69	URO-TANGENTIAL FORCEPS 26CM	117
TITAN BULLDOG CLAMPS, ARTERIA, 35MM,	95	UTERINE PERFORATOR, MOD. ERLANGEN	279
TITAN BULLDOG CLAMPS, ARTERIA, 35MM,	95	VALLEIX UTERINE PROBE W.SLIDE 25.0 CM	277
TITAN BULLDOG CLAMPS, ARTERIA, 40MM,	95	VALVE 100X38 MM	200
TITAN BULLDOG CLAMPS, ARTERIA, 40MM,	95	VALVE 58/X50 MM	200
TITAN BULLDOG CLAMPS, VENA, 35MM,	95	VALVE 62X38 MM	200
TITAN BULLDOG CLAMPS, VENA, 35MM, STR.	95	VALVE 80X38 MM	200
TITAN BULLDOG CLAMPS, VENA, 40MM,	95	VALVE 80X38 MM	200
TITAN BULLDOG CLAMPS, VENA, 40MM, STR.	95	VALVE 80X60 MM	200
TOENNIS ARTERY FORCEPS CVD 1X2 T 21.0	111	VALVE 85X72 MM	200
TOENNIS ARTERY FORCEPS CVD 1X2 T 26.0CM	111	VERRES NEEDLE 2.0X100 MM	225
TOENNIS ARTERY FORCEPS CVD 21.0 CM	111	VERRES NEEDLE 2.0X150 MM	225
TOENNIS ARTERY FORCEPS CVD 26.0 CM	111	VERRES TUBES 2,0 X 120MM	225
TOENNIS ARTERY FORCEPS STR 1X2 T.	111	VESSEL DILATOR	81
TOENNIS ARTERY FORCEPS STR 1X2 T.,26,0CM	111	VESSEL DILATOR	81
TOENNIS ARTERY FORCEPS STR 21.0 CM	111	VESSEL DILATORS	81
TOENNIS ARTERY FORCEPS STR 26.0 CM	111	VESSEL DILATORS, 0,3 MM, 11.0 CM	80
TOENNIS DISS.SCISSORS CVD BL 18.0 CM	33	VESSEL DILATORS, 0,3 MM, 45° ANGLED,	80
TOENNIS DISS.SCISSORS STR 18.0 CM	32	VESSEL DILATORS, 0,3 MM, 45° ANGLED,	81
TOENNIS NEEDLE HOLDER 18.0 CM	128	VESSEL DILATORS, 0,3 MM, 90° ANGLED,	80
TOENNIS, NEEDLE HOLDER WITH TC, 18,0 CM	140	VESSEL DILATORS, DIAMOND COATED, 0,3	80
TOENNIS-ADSON DISS.SCS CVD BL/BL 17.5.CM	24	VIRCHOW, AUTOPSY KNIFE, BLADE 16.0 CM	9
TOENNIS-ADSON SCS DELI TC CVD 17.5 CM	50	VIRCHOW, AUTOPSY KNIFE, BLADE 20.0 CM	9
TOENNIS-ADSON, DISSEC.-SCS. SC, CRV.	56	VIRCHOW, BRAIN KNIFE, BLADE 24.0 CM	9
TOHOKU-JAPAN TOWEL FORCEPS 10 CM	88	VOLKMANN BONE CURETTE, FIG.00 17 CM	298
TOHOKU-JAPAN TOWEL FORCEPS 13 CM	88	VOLKMANN BONE CURETTE, FIG.000 17 cm	298
TOOMEY, SYRINGE, 50 ML	228	VOLKMANN BONE CURETTE, FIG.0000 17 CM	298
TOWEL FCPS WITH CLIP FOR TUBING 11,0 CM	86	VOLKMANN BONE CURETTE, FIG.1 17 CM	298
TOWEL FCPS., FOR PAPER CLOTHS, 13,5 CM	87	VOLKMANN BONE CURETTE, FIG.2 17 CM	298
TRELAT LIGATURE NEEDLE 23.0 CM	150	VOLKMANN BONE CURETTE, FIG.3 17 CM	298
TREVES, TISSUE FCPS., 1X2 TEETH, 13.0	76	VOLKMANN BONE CURETTE, FIG.4 17 CM	298
TREVES, TISSUE FCPS., 1X2 TEETH, 15.0	76	VOLKMANN BONE CURETTE, FIG.5 17 CM	298
TROCAR FOR CANNULA, Ø 1,4 X 168 MM	226	VOLKMANN BONE CURETTE, FIG.6 17 CM	298
TROCAR FOR CANNULA, Ø 1,8 X 168 MM	226	VOLKMANN CURETTE FIG.0 17 CM	298
TUBERCULINE SYRINGE, LUER-LOCK, 1 ML	228	VOLKMANN RETR.BLUNT 1 PRONG 21.5 CM	171
TUBING CLAMP 15.5 CM	91	VOLKMANN RETR.BLUNT 2 PRONGS 21.5 CM	171
TUBING CLAMP 15.5 CM WITH CLIP	91	VOLKMANN RETR.BLUNT 3 PRONGS 21.5 CM	171
TUBING CLAMP 18.0 CM	91	VOLKMANN RETR.BLUNT 4 PRONGS 21.5 CM	171
TUBING CLAMP 20.0 CM	91	VOLKMANN RETR.BLUNT 6 PRONGS 21.5 CM	171
TUBING CLAMP 20.0 CM WITH CLIP	91	VOLKMANN RETR.SEMI-SHARP 2 PRONGS	170
TUFFIER ABDOMINAL SPATULA 20.0 CM	210	VOLKMANN RETR.SEMI-SHARP 3 PRONGS	170
TUFFIER ARTERY FORCEPS 5X4 TEETH 13.0	96	VOLKMANN RETR.SEMI-SHARP 4 PRONGS	170
TUFFIER RIB SPREADER 50X45MM/165MM	211	VOLKMANN RETR.SEMI-SHARP 6 PRONGS	170
TUOHY NEEDLE, 1,20 X 76 MM	226	VOLKMANN RETR.SHARP 1 PRONG 21.5 CM	170
TUOHY NEEDLE, 1,40 X 76 MM	226	VOLKMANN RETR.SHARP 2 PRONGS 21.5 CM	170
TUOHY NEEDLE, 1,60X76 MM	226	VOLKMANN RETR.SHARP 3 PRONGS 21.5 CM	170
TURNER-WARWICK MODIF., ABDOMINAL	203	VOLKMANN RETR.SHARP 4 PRONGS 21.5 CM	170

VOLKMANN RETR.SHARP 6 PRONGS 21.5 CM	170	WINTER OVUM FORCEPS,FIG.1,STR.,28.0CM	291
VOLKMANN, BONE CURETTE	300	WINTER OVUM FORCEPS,FIG.2,CURVED 28.0CM	291
VOLKMANN, BONE CURETTE	300	WINTER OVUM FORCEPS,FIG.2,STR.,28.0CM	291
VOLKMANN, BONE CURETTE,	300	WINTER OVUM FORCEPS,FIG.3,CURVED,28.0CM	291
VOLKMANN, RETRACTOR	170	WITTNER BIOPSY FORCEPS CURVED 23.0 CM	287
VOLKMANN, RETRACTOR, 8 PRONGS,	170	WITTNER BIOPSY FORCEPS STRAIGHT 23.0 CM	287
VOLKMANN, RETRACTOR, 8 PRONGS, BLUNT,	171	WRIGLEY, OBSTETRICAL FORCEPS, 28.0CM	289
VOLKMANN, RETRACTOR, 8 PRONGS, SHARP,	170	WULLSTEIN, SELF-RETAINING RETRACTOR,	190
WACHENFELDT SUTURE FORCEPS 12.5 CM	154	WULLSTEIN, SELF-RETAINING RETRACTOR,	190
WAGNER FINE SCISSORS CVD BL/BL 12.0 CM	28	WULLSTEIN, SELF-RETAINING RETRACTOR,	190
WAGNER FINE SCISSORS CVD SH/SH 12.0 CM	28	WULLSTEIN, SELF-RETAINING RETRACTOR,	190
WAGNER FINE SCISSORS STR BL/BL 12.0 CM	28	WULLSTEIN, SELF-RETAINING RETRACTOR,	190
WAGNER FINE SCISSORS STR SH/SH 12.0 CM	28	WULLSTEIN, SELF-RETAINING RETRACTOR,	190
WALB, AUTOPSY KNIFE, BLADE 11,0 CM	9	WULLSTEIN, SELF-RETAINING RETRACTOR,	190
WALB, AUTOPSY KNIFE, BLADE 14,0 CM	9	WULLSTEIN, SELF-RETAINING RETRACTOR,	190
WALB, AUTOPSY KNIFE, BLADE 17,0 CM	9	YANKAUER, SUCTION TUBE,	222
WALDMANN EPISIOTOMY SCS SAW EDGE 18.0	43	YEOMAN RECTAL BIOPSY FCPS FIG.1 28.0 CM	255
WALLICH OVUM SCOOPS, 42.0CM	292	YEOMAN RECTAL BIOPSY FCPS FIG.1 35.0 CM	255
WALTER-CARMALT SPLINTER FCPS CVD 10.5	78	YEOMAN RECTAL BIOPSY FCPS FIG.1 42.0 CM	255
WALTER-CARMALT SPLINTER FCPS STR 10.5	78	YEOMAN RECTAL BIOPSY FCPS FIG.2 28.0 CM	255
WALTON FINGER RING SAW 16 CM	296	YEOMAN RECTAL BIOPSY FCPS FIG.2 35.0 CM	255
WALTON SAW BLADE ONLY 20MM	296	YEOMAN RECTAL BIOPSY FCPS FIG.2 42.0 CM	255
WALTON, COMEDO EXTRACTOR, 14,0 CM	295	YEOMAN RECTAL BIOPSY FCPS FIG.3 28.0 CM	255
WANGENSTEEN NEEDLE HOLDER 27.0 CM	127	YEOMAN RECTAL BIOPSY FCPS FIG.3 35.0 CM	255
WANGENSTEEN TISSUE FORCEPS TC 15.0 CM	82	YEOMAN RECTAL BIOPSY FCPS FIG.3 42.0 CM	255
WANGENSTEEN TISSUE FORCEPS TC 23.0 CM	82	YEOMAN RECTAL BIOPSY FCPS FIG.4 28.0 CM	255
WANGENSTEEN, NEEDLE HOLDER WITH TC,	138	YEOMAN RECTAL BIOPSY FCPS FIG.4 35.0 CM	255
WANGENSTEEN, TISSUE FORCEPS, TC, 25.0	82	YEOMAN RECTAL BIOPSY FCPS FIG.4 42.0 CM	255
WATSON-CHEYNE, DISSECTOR, 17,5 CM	301	YOUNG PROSTATIC RETRACTOR 21CM	239
WAUGH, DRESSING FORCEPS, 15.0 CM	68	YOUNG PROSTATIC RETRACTOR 21CM	239
WAUGH, DRESSING FORCEPS, 20.0 CM	68	YOUNG PROSTATIC RETRACTOR 22CM	239
WAUGH, TISSUE FCPS., 1X2 T, SERRATED,	74	YOUNG PROSTATIC RETRACTOR 22CM	239
WAUGH, TISSUE FCPS., 1X2 T, SERRATED,	74	YOUNG-HRYNTSCHAK NEEDLE HOLDER 24.0 CM	149
WEBSTER NEEDLE HOLDER SMOOTH JAWS	124	ZENKER DISS.FCPS SLIGHTLY CVD 29.5 CM	113
WEBSTER NEEDLE HOLDER TC 13.0 CM	133	ZENKER DISS.FCPS STRONGLY CVD 29.5 CM	113
WEBSTER NEEDLE HOLDER TC, SMOOTH, 13.0	133	ZENKER RETRACTOR 35X8 MM 27.5 CM	182
WEISSBARTH, VAGINAL SPECULA, W.	260	ZENKER RETRACTOR 60X12 MM 26.0 CM	182
WEITLANER RETRACTOR BLUNT 13.0 CM	191	ZENKER RETRACTOR 75X12 MM 25.0 CM	182
WEITLANER RETRACTOR BLUNT 16.5 CM	191	ZWEIFEL NEEDLE HOLDER TC 20.0 CM	143
WEITLANER RETRACTOR BLUNT 20.0 CM	191	ZWEIFEL NEEDLE HOLDER TC 23.0 CM	143
WEITLANER RETRACTOR BLUNT 24 CM	192		
WEITLANER RETRACTOR SHARP 13.0 CM	191		
WEITLANER RETRACTOR SHARP 16.5 CM	191		
WEITLANER RETRACTOR SHARP 20.0 CM	191		
WEITLANER RETRACTOR SHARP 24 CM	192		
WEITLANER-BABY RETRACTOR 13.0 CM	193		
WEITLANER-LOKTITE, RETRACTOR BLUNT	191		
WEITLANER-LOKTITE, RETRACTOR SHARP	191		
WERTHEIM CLAMP-FCPS EXTRA STRONG 24,0CM	119		
WERTHEIM CLAMP-FCPS MORE CURVED 23,0 CM	120		
WERTHEIM CLAMP-FORCEPS 25.0 CM	119		
WERTHEIM OPER.SCISSORS CVD BL/BL 19.5	41		
WERTHEIM OPER.SCISSORS CVD BL/BL 22.5	41		
WERTHEIM, HYSTERECTOMY CLAMP-FORCEPS	120		
WERTHEIM, VAGINAL SPECULA, 95X38MM 30 CM	268		
WERTHEIM-CULLEN CLAMP-FORCEPS 21.5 CM	120		
WESTCOTT TENOTOMY SCISSORS BLUNT 11.0	59		
WESTCOTT TENOTOMY SCS.POINTED 11.0 CM	59		
WIKSTROEM DISS.AND LIG.FCPS.CVD 19.0 CM	112		
WIKSTROEM DISS.AND LIG.FCPS.CVD 21.0 CM	112		
WIKSTROEM DISS.AND LIG.FCPS.CVD 24.0 CM	112		
WILLAUER, LOBECTOMY AND RECTAL SCS.,	42		
WILLAUER, LOBECTOMY AND RECTAL SCS.,	42		
WILLAUER, LOBECTOMY AND RECTAL SCS.,	42		
WILLAUER, LOBECTOMY AND RECTAL SCS.,	42		
WILLET-MARTEL SCALP FLAP FORCEPS 19,0	97		
WILLIAMS, INTESTINAL GRASPING FORCEPS,	243		
WILLIGER ELEVATOR 16.0 CM	301		
WILLIGER ELEVATOR 6 MM 17.0 CM	301		
WILLIGER, BONE CURETTE	300		
WILLIGER, BONE CURETTE	300		
WILLIGER, BONE CURETTE,	300		
WILLIGER, PERIOSTEAL RASPATORY,	303		
WILLIGER, PERIOSTEAL RASPATORY, 4 MM,	303		
WILLIGER, PERIOSTEAL RASPATORY, 6 MM,	303		
WILLIGER, SHARP SPOON	300		
WILLIGER, SHARP SPOON	300		
WINTER OVUM FORCEPS, FIG.3,STR.,28.0CM	291		
WINTER OVUM FORCEPS, STRAIGHT, 27.0CM	291		
WINTER OVUM FORCEPS,FIG.1,CURVED 28.0CM	291		

Inhaltsverzeichnis numerisch
Index numerical

Inhaltsverzeichnis numerisch
Index numerical

10-1003-00	2	10-1078-15	7	11-1002-16	14
10-1003-01	2	10-1078-16	7	11-1002-17	14
10-1003-02	2	10-1080-13	8	11-1002-18	14
10-1004-00	3	10-1080-16	8	11-1002-20	14
10-1004-01	3	10-1080-19	8	11-1003-10	14
10-1007-00	2	10-1080-22	8	11-1003-11	14
10-1007-01	2	10-1080-28	8	11-1003-13	14
10-1008-00	3	10-1082-16	8	11-1003-14	14
10-1009-00	3	10-1082-19	8	11-1003-15	14
10-1050-10	4	10-1082-22	8	11-1003-16	14
10-1050-11	4	10-1105-55	10	11-1003-17	14
10-1050-11S	4	10-1110-65	10	11-1003-18	14
10-1050-12	4	10-1150-11	9	11-1003-20	14
10-1050-12D	4	10-1150-14	9	11-1004-10	15
10-1050-13	4	10-1150-17	9	11-1004-11	15
10-1050-15	4	10-1180-16	9	11-1004-13	15
10-1050-15C	4	10-1180-20	9	11-1004-14	15
10-1050-18	5	10-1180-24	9	11-1004-15	15
10-1050-19	5	10-1250-17	8	11-1004-16	15
10-1050-20	5	10-1250-20	8	11-1004-17	15
10-1050-21	5	10-1250-22	8	11-1004-18	15
10-1050-22	5	10-1280-10	9	11-1004-20	15
10-1050-23	5	10-1280-12	9	11-1005-10	15
10-1050-24	5	10-1400-19	11	11-1005-11	15
10-1050-25	5	10-1401-19	11	11-1005-13	15
10-1060-10	6	10-1410-30	11	11-1005-14	15
10-1060-12	6	10-1411-30	11	11-1005-15	15
10-1060-14	6	10-1412-35	11	11-1005-16	15
10-1060-16	6	10-1413-35	11	11-1005-17	15
10-1060-18	6	10-1420-30	11	11-1005-18	15
10-1066-01	6	10-1421-30	11	11-1005-20	15
10-1066-02	6	10-1422-30	10	11-1009-13	19
10-1066-03	6	11-1000-10	14	11-1050-12	15
10-1066-04	6	11-1000-11	14	11-1050-13	15
10-1066-05	6	11-1000-13	14	11-1050-14	15
10-1066-06	6	11-1000-14	14	11-1051-12	15
10-1070-01	7	11-1000-15	14	11-1051-13	15
10-1070-02	7	11-1000-16	14	11-1051-14	15
10-1070-03	7	11-1000-17	14	11-1052-12	16
10-1070-04	7	11-1000-18	14	11-1052-13	16
10-1070-05	7	11-1000-20	14	11-1052-14	16
10-1070-06	7	11-1001-10	14	11-1053-12	16
10-1070-07	7	11-1001-11	14	11-1053-13	16
10-1070-08	7	11-1001-13	14	11-1053-14	16
10-1070-09	7	11-1001-14	14	11-1054-12	16
10-1070-10	7	11-1001-15	14	11-1054-13	16
10-1076-01	7	11-1001-16	14	11-1054-14	16
10-1076-02	7	11-1001-17	14	11-1055-12	16
10-1076-03	7	11-1001-18	14	11-1055-13	16
10-1076-04	7	11-1001-20	14	11-1055-14	16
10-1076-05	7	11-1002-10	14	11-1070-13	17
10-1076-06	7	11-1002-11	14	11-1070-14	17
10-1076-07	7	11-1002-13	14	11-1071-13	17
10-1076-08	7	11-1002-14	14	11-1071-14	17
10-1076-09	7	11-1002-15	14	11-1072-13	17

11-1072-14	17	11-1114-23	22	11-1200-12	26
11-1073-13	17	11-1114-25	22	11-1200-15	26
11-1073-14	17	11-1114-28	22	11-1200-18	26
11-1074-13	18	11-1114-30	22	11-1200-20	26
11-1074-14	18	11-1115-14	20	11-1201-12	26
11-1075-13	18	11-1115-18	22	11-1201-15	26
11-1075-14	18	11-1115-20	22	11-1201-18	26
11-1100-14	18	11-1115-23	22	11-1201-20	26
11-1100-23	18	11-1115-25	22	11-1210-15	26
11-1100-28	18	11-1115-28	22	11-1210-18	26
11-1101-14	18	11-1115-30	22	11-1211-15	26
11-1101-17	18	11-1120-14	22	11-1211-18	26
11-1101-23	18	11-1120-18	22	11-1211-20	26
11-1101-28	18	11-1120-20	22	11-1211-23	26
11-1102-15	19	11-1120-23	22	11-1211-25	25
11-1102-17	19	11-1120-25	22	11-1217-19	27
11-1102-19	19	11-1120-28	22	11-1217-25	27
11-1102-21	19	11-1120-30	22	11-1220-15	27
11-1103-15	19	11-1121-14	22	11-1221-15	27
11-1103-17	19	11-1121-18	23	11-1224-14	27
11-1103-19	19	11-1121-20	23	11-1225-14	27
11-1103-21	19	11-1121-23	23	11-1228-14	27
11-1104-17	19	11-1121-25	23	11-1229-14	27
11-1105-17	19	11-1121-28	23	11-1230-12	28
11-1110-11	20	11-1121-30	23	11-1231-12	28
11-1110-14	20	11-1124-14	23	11-1234-12	28
11-1110-18	21	11-1124-18	23	11-1235-12	28
11-1110-20	21	11-1124-20	23	11-1240-11	28
11-1110-23	21	11-1124-23	23	11-1241-11	28
11-1110-25	21	11-1124-25	23	11-1244-09	28
11-1110-28	21	11-1124-28	23	11-1244-10	28
11-1110-30	21	11-1124-30	23	11-1244-11	28
11-1111-11	10	11-1125-14	23	11-1245-09	28
11-1111-14	20	11-1125-18	23	11-1245-10	28
11-1111-18	20	11-1125-20	23	11-1245-11	28
11-1111-20	21	11-1125-23	23	11-1250-10	29
11-1111-23	21	11-1125-25	23	11-1250-11	29
11-1111-25	21	11-1125-28	23	11-1251-10	29
11-1111-28	21	11-1125-30	23	11-1251-11	29
11-1111-30	21	11-1127-18	24	11-1261-11	29
11-1112-18	21	11-1127-20	24	11-1263-11	29
11-1112-20	21	11-1127-23	24	11-1264-12	30
11-1112-23	21	11-1129-18	24	11-1265-12	30
11-1112-25	21	11-1129-20	24	11-1270-08	30
11-1112-28	21	11-1129-23	24	11-1271-08	30
11-1112-30	21	11-1137-14	24	11-1276-14	31
11-1113-14	20	11-1139-17	24	11-1277-14	31
11-1113-18	21	11-1140-10	25	11-1280-12	31
11-1113-20	21	11-1140-16	25	11-1283-12	31
11-1113-23	21	11-1140-21	25	11-1285-12	31
11-1113-25	21	11-1141-10	25	11-1290-10	31
11-1113-28	21	11-1141-16	25	11-1290-11	31
11-1113-30	21	11-1141-21	25	11-1291-10	31
11-1114-18	22	11-1160-17	25	11-1291-11	31
11-1114-20	22	11-1161-17	25	11-1294-10	31

11-1294-11	31	11-1548-24	37	11-1689-28	42
11-1295-10	31	11-1550-12	37	11-1691-19	42
11-1295-11	31	11-1550-25	37	11-1693-27	42
11-1300-13	32	11-1550-45	37	11-1695-18	43
11-1300-14	32	11-1550-60	37	11-1701-14	43
11-1302-16	32	11-1550-90	37	11-1701-20	43
11-1310-14	32	11-1551-25	38	11-1703-20	43
11-1312-12	32	11-1551-45	38	11-1706-10	43
11-1315-16	32	11-1551-60	38	11-1707-13	43
11-1315-18	32	11-1552-12	38	11-1707-16	43
11-1324-18	32	11-1560-15	38	11-1709-16	43
11-1325-18	33	11-1561-15	38	11-1800-12	44
11-1341-19	33	11-1562-15	38	11-1900-09	44
11-1343-15	33	11-1570-19	39	11-1900-11	44
11-1400-09	33	11-1572-11	39	11-1900-14	44
11-1400-10	33	11-1575-30	39	11-1900-18	44
11-1400-13	33	11-1577-24	39	11-1900-20	44
11-1402-11	33	11-1579-23	39	11-1901-18	44
11-1402-14	33	11-1600-20	39	11-1901-21	44
11-1404-14	33	11-1600-23	39	11-1903-16	44
11-1404-18	33	11-1601-20	40	11-1903-19	44
11-1408-16	34	11-1601-23	40	11-1905-23	44
11-1411-19	34	11-1602-20	39	11-1907-20	45
11-1413-13	34	11-1602-23	39	11-1907-22	45
11-1415-12	34	11-1603-20	40	11-1909-24	45
11-1450-22	34	11-1603-23	40	11-1910-24	45
11-1453-17	34	11-1604-20	39	11-1920-14	45
11-1457-17	35	11-1604-23	39	11-1930-23	45
11-1458-17	35	11-1605-20	40	11-1940-16	45
11-1459-17	35	11-1605-23	40	11-1940-18	45
11-1501-18	35	11-1610-16	40	11-1940-20	45
11-1511-16	35	11-1610-17	40	11-1940-23	45
11-1517-18	35	11-1611-16	40	11-1941-20	45
11-1519-22	35	11-1611-17	40	11-1950-14	45
11-1521-18	36	11-1612-16	40	11-1950-16	45
11-1523-17	36	11-1620-24	40	11-1950-18	45
11-1525-19	36	11-1622-22	40	12-1000-14	46
11-1528-20	36	11-1634-16	40	12-1000-16	46
11-1540-25	36	11-1634-18	40	12-1000-18	46
11-1540-45	36	11-1635-16	41	12-1001-14	46
11-1540-60	36	11-1635-18	41	12-1001-16	46
11-1541-25	36	11-1640-19	41	12-1001-18	46
11-1541-45	36	11-1640-23	41	12-1002-14	46
11-1541-60	36	11-1650-18	41	12-1002-16	46
11-1542-25	36	11-1651-18	41	12-1002-18	46
11-1542-45	36	11-1670-21	41	12-1003-14	46
11-1542-60	36	11-1672-21	41	12-1003-16	46
11-1543-25	36	11-1674-21	41	12-1003-18	46
11-1543-45	36	11-1677-27	41	12-1004-14	46
11-1543-60	36	11-1680-31	42	12-1004-16	46
11-1544-25	36	11-1681-31	42	12-1004-18	46
11-1544-45	36	11-1685-32	42	12-1005-14	46
11-1544-60	36	11-1688-25	42	12-1005-16	46
11-1547-18	37	11-1688-28	42	12-1005-18	46
11-1548-21	37	11-1689-25	42	12-1100-14	47

12-1100-17	47	12-1120-20	50	12-1551-25	54
12-1100-23	47	12-1120-23	50	12-1551-45	54
12-1101-14	47	12-1120-25	50	12-1551-60	54
12-1101-17	47	12-1120-28	50	12-1552-17	53
12-1101-23	47	12-1120-30	50	12-1600-20	52
12-1102-15	47	12-1121-14	49	12-1600-23	52
12-1102-17	47	12-1121-18	50	12-1601-20	52
12-1103-15	47	12-1121-20	50	12-1601-23	52
12-1103-17	47	12-1121-23	50	12-1602-20	52
12-1110-11	48	12-1121-25	50	12-1602-23	52
12-1110-14	48	12-1121-28	50	12-1603-20	52
12-1110-18	48	12-1121-30	50	12-1603-23	52
12-1110-20	48	12-1124-14	49	12-1604-20	52
12-1110-23	48	12-1124-18	50	12-1604-23	52
12-1110-25	48	12-1124-20	50	12-1605-20	52
12-1110-28	48	12-1124-23	50	12-1605-23	52
12-1110-30	48	12-1124-25	50	12-1663-25	51
12-1111-11	48	12-1124-28	50	12-1665-25	51
12-1111-14	48	12-1124-30	50	12-1800-12	55
12-1111-18	48	12-1125-14	49	12-1900-18	55
12-1111-20	48	12-1125-18	50	12-1909-24	55
12-1111-23	48	12-1125-20	50	13-1100-17	56
12-1111-25	48	12-1125-23	50	13-1101-17	56
12-1111-28	48	12-1125-25	50	13-1110-11	57
12-1111-30	48	12-1125-28	50	13-1110-14	57
12-1112-14	48	12-1125-30	50	13-1111-14	56
12-1112-18	49	12-1127-18	51	13-1111-18	56
12-1112-20	49	12-1127-20	51	13-1111-20	56
12-1112-23	49	12-1127-23	51	13-1111-23	56
12-1112-25	49	12-1129-18	51	13-1121-14	56
12-1112-28	49	12-1129-20	51	13-1121-18	56
12-1112-30	49	12-1129-23	51	13-1121-20	56
12-1113-14	48	12-1137-14	50	13-1121-23	56
12-1113-18	49	12-1139-17	50	13-1129-15	56
12-1113-20	49	12-1140-16	47	13-1129-19	56
12-1113-23	49	12-1140-21	47	13-1130-13	56
12-1113-25	49	12-1141-16	47	13-1133-18	56
12-1113-28	49	12-1141-21	47	13-1139-17	56
12-1113-30	49	12-1210-15	51	13-1200-12	58
12-1114-14	48	12-1211-15	51	13-1201-12	58
12-1114-18	49	12-1244-11	55	13-1210-12	57
12-1114-20	49	12-1245-11	55	13-1218-15	57
12-1114-23	49	12-1273-08	30	13-1218-18	57
12-1114-25	49	12-1543-25	53	13-1240-11	57
12-1114-28	49	12-1543-45	53	13-1241-11	57
12-1114-30	49	12-1543-60	53	13-1244-11	57
12-1115-14	48	12-1545-25	53	13-1245-11	57
12-1115-18	49	12-1545-45	53	13-1290-11	57
12-1115-20	49	12-1545-60	53	13-1291-11	57
12-1115-23	49	12-1548-24	53	13-1343-15	58
12-1115-25	49	12-1550-12	54	13-1511-16	58
12-1115-28	49	12-1550-25	54	13-1551-25	58
12-1115-30	49	12-1550-45	54	13-1551-45	58
12-1120-14	49	12-1550-60	54	13-1551-60	58
12-1120-18	50	12-1550-90	54	15-1081-11	59

15-1083-11	59	16-1003-20	64	16-1018-25	65
15-1201-15	60	16-1003-25	64	16-1018-30	65
15-1201-18	60	16-1003-30	64	16-1026-18	67
15-1203-15	61	16-1004-10	64	16-1026-21	67
15-1203-18	61	16-1004-11	64	16-1026-25	67
15-1223-15	60	16-1004-13	64	16-1027-18	67
15-1223-15Z	60	16-1004-14	64	16-1027-21	67
15-1232-15	61	16-1004-15	64	16-1027-25	67
15-1232-15Z	61	16-1004-16	64	16-1036-13	67
15-1241-14Z	59	16-1004-18	64	16-1036-14	67
15-1241-16Z	59	16-1004-20	64	16-1036-15	67
15-1243-14	59	16-1004-25	64	16-1040-12	67
15-1243-16	59	16-1004-30	64	16-1040-15	67
15-1246-01	59	16-1006-10	65	16-1070-12	66
15-1246-02	59	16-1006-13	65	16-1070-15	66
15-1246-03	59	16-1006-14	65	16-1076-12	66
15-1270-12	60	16-1006-15	65	16-1076-15	66
15-1270-25	60	16-1006-18	65	16-1092-17	67
15-1270-45	60	16-1006-20	65	16-1093-17	67
15-1270-60	60	16-1006-25	65	16-1094-20	67
15-1270-90	60	16-1006-30	65	16-1095-20	68
15-1271-12	60	16-1008-15	66	16-1102-18	66
15-1271-25	60	16-1010-10	64	16-1103-18	67
15-1271-45	60	16-1010-11	64	16-1114-17	66
15-1271-60	60	16-1010-13	64	16-1115-17	66
15-1271-90	60	16-1010-14	64	16-1117-18	66
15-1290-01	59	16-1010-15	64	16-1120-18	68
15-1290-02	59	16-1010-16	64	16-1126-20	68
15-1290-03	59	16-1010-18	64	16-1130-15	68
15-1290-04	59	16-1010-20	64	16-1130-20	68
15-1291-01	59	16-1010-25	64	16-1136-18	68
15-1291-02	59	16-1010-30	64	16-1158-15	66
15-1291-03	59	16-1011-10	65	16-1200-10	69
15-1291-04	59	16-1011-11	65	16-1200-11	69
15-1292-01	59	16-1011-13	65	16-1200-13	69
15-1292-02	59	16-1011-14	65	16-1200-14	69
15-1293-01	59	16-1011-16	65	16-1200-15	69
15-1293-02	59	16-1011-18	65	16-1200-16	69
16-1002-10	64	16-1011-20	65	16-1200-18	69
16-1002-11	64	16-1011-25	65	16-1200-20	69
16-1002-13	64	16-1011-30	65	16-1200-25	69
16-1002-14	64	16-1012-11	65	16-1200-30	69
16-1002-15	64	16-1012-13	65	16-1206-12	71
16-1002-16	64	16-1012-14	65	16-1206-13	71
16-1002-18	64	16-1012-15	65	16-1206-14	71
16-1002-20	64	16-1012-18	65	16-1206-15	71
16-1002-25	64	16-1012-20	65	16-1206-18	71
16-1002-30	64	16-1012-25	65	16-1206-20	71
16-1003-10	64	16-1018-10	65	16-1206-25	71
16-1003-11	64	16-1018-11	65	16-1206-30	71
16-1003-13	64	16-1018-13	65	16-1208-15	72
16-1003-14	64	16-1018-14	65	16-1209-15	72
16-1003-15	64	16-1018-16	65	16-1210-13	70
16-1003-16	64	16-1018-18	65	16-1210-14	70
16-1003-18	64	16-1018-20	65	16-1210-15	70

16-1210-16	70	16-1256-20	69	16-1586-14	75
16-1210-18	70	16-1270-12	71	16-1587-14	75
16-1210-20	70	16-1270-15	71	16-1590-18	76
16-1210-25	70	16-1274-12	72	16-1592-18	76
16-1210-30	70	16-1274-15	72	16-1601-03	80
16-1212-12	71	16-1276-12	71	16-1601-04	80
16-1212-13	71	16-1276-15	71	16-1601-05	80
16-1212-14	71	16-1282-12	72	16-1601-07	80
16-1212-15	71	16-1288-12	72	16-1620-01	80
16-1212-18	71	16-1288-15	72	16-1620-02	80
16-1212-20	71	16-1292-17	74	16-1620-03	80
16-1212-25	71	16-1293-17	74	16-1620-04	80
16-1212-30	71	16-1294-20	74	16-1634-12	81
16-1218-13	70	16-1295-20	74	16-1634-13	81
16-1218-14	70	16-1300-15	72	16-1635-13	81
16-1218-15	70	16-1302-18	73	16-1637-13	81
16-1218-16	70	16-1303-18	73	16-1650-07	78
16-1218-18	70	16-1314-17	73	16-1650-09	78
16-1218-20	70	16-1315-17	73	16-1650-11	78
16-1218-25	70	16-1317-17	73	16-1652-10	78
16-1218-30	70	16-1330-15	74	16-1653-10	78
16-1219-13	70	16-1330-20	74	16-1656-10	78
16-1219-14	70	16-1358-15	73	16-1657-10	78
16-1219-16	70	16-1382-15	72	16-1662-08	77
16-1219-18	70	16-1382-20	72	16-1662-09	77
16-1219-20	70	16-1384-15	72	16-1662-10	77
16-1226-18	74	16-1384-20	72	16-1662-11	77
16-1226-21	74	16-1410-15	76	16-1662-13	77
16-1226-25	74	16-1410-20	76	16-1662-14	77
16-1227-18	74	16-1410-25	76	16-1663-08	77
16-1227-21	74	16-1420-14	76	16-1663-09	77
16-1227-25	74	16-1420-20	76	16-1663-10	77
16-1236-13	70	16-1422-14	76	16-1663-11	77
16-1236-14	70	16-1422-20	76	16-1663-13	77
16-1236-15	70	16-1456-15	74	16-1663-14	77
16-1240-12	73	16-1456-20	74	16-1666-08	77
16-1240-15	73	16-1456-25	74	16-1666-09	77
16-1242-12	73	16-1460-14	75	16-1666-10	77
16-1252-11	69	16-1460-16	75	16-1666-11	77
16-1252-13	69	16-1460-20	75	16-1666-13	77
16-1252-14	69	16-1470-12	75	16-1666-14	77
16-1252-16	69	16-1470-20	68	16-1667-08	77
16-1252-18	69	16-1470-23	75	16-1667-09	77
16-1252-20	69	16-1470-34	75	16-1667-10	77
16-1252-25	69	16-1494-01	75	16-1667-11	77
16-1252-30	69	16-1494-02	75	16-1667-13	77
16-1254-13	69	16-1494-03	75	16-1667-14	77
16-1254-14	69	16-1510-13	76	16-1700-16	81
16-1254-16	69	16-1510-15	76	16-1700-20	81
16-1254-18	69	16-1516-23	68	16-1700-24	81
16-1254-20	69	16-1518-15	75	16-1700-30	81
16-1256-13	69	16-1518-20	75	16-1701-16	81
16-1256-14	69	16-1518-23	75	16-1701-20	81
16-1256-16	69	16-1520-18	76	16-1701-24	81
16-1256-18	69	16-1522-18	76	16-1701-30	81

16-1702-16	81	17-1200-20	82	22-1000-09	86
16-1702-20	81	17-1200-25	82	22-1000-11	86
16-1702-24	81	17-1200-30	82	22-1000-13	86
16-1702-30	81	17-1208-14	82	22-1000-15	86
16-1703-16	81	17-1208-16	82	22-1005-11	86
16-1703-20	81	17-1208-18	82	22-1010-13	86
16-1703-24	81	17-1208-20	82	22-1010-15	87
16-1703-30	81	17-1208-25	82	22-1014-10	87
16-1704-16	81	17-1208-30	82	22-1014-13	87
16-1704-20	81	17-1270-12	83	22-1020-10	88
16-1704-24	81	17-1270-15	83	22-1020-13	88
16-1704-30	81	17-1300-15	83	22-1024-13	87
16-1706-16	81	17-1302-17	83	22-1030-14	88
16-1706-20	81	17-1590-17	83	22-1040-15	87
16-1706-24	81	20-1014-03	94	22-1040-18	87
16-1706-30	81	20-1014-05	94	22-1040-20	87
16-1708-16	81	20-1015-03	94	22-1044-16	86
16-1708-20	81	20-1015-05	94	22-1101-09	86
16-1708-24	81	20-1018-04	94	22-1105-05	86
16-1708-30	81	20-1018-05	94	22-1105-07	86
16-1716-16	81	20-1018-06	94	22-1105-09	86
16-1716-20	81	20-1018-07	94	22-1107-09	86
16-1716-24	81	20-1018-09	94	22-1109-09	86
16-1716-30	81	20-1019-04	94	22-1160-18	90
16-1718-16	81	20-1019-05	94	22-1160-20	90
16-1718-20	81	20-1019-06	94	22-1160-25	90
16-1718-24	81	20-1019-07	94	22-1161-18	90
16-1718-30	81	20-1019-09	94	22-1161-20	90
16-1806-10	78	20-1292-07	95	22-1161-25	90
16-1807-10	78	20-1292-08	95	22-1170-18	90
16-1809-10	78	20-1292-10	95	22-1170-20	90
16-1810-10	79	20-1292-12	95	22-1170-25	90
16-1811-10	79	20-1293-07	95	22-1171-18	90
16-1813-10	79	20-1293-08	95	22-1171-20	90
16-1814-10	79	20-1293-10	95	22-1171-25	90
16-1815-10	79	20-1293-12	95	22-1180-25	90
16-1817-10	79	20-1295-23	94	22-1181-25	90
17-1026-15	83	20-1298-07	96	22-1190-18	90
17-1026-18	83	20-1298-09	96	22-1190-25	90
17-1026-20	83	20-1298-11	96	22-1200-22	89
17-1040-12	82	20-1299-06	96	22-1200-25	89
17-1040-15	82	20-1299-09	96	22-1200-27	89
17-1070-12	83	20-1299-11	96	22-1201-22	89
17-1070-15	83	20-1520-01	94	22-1201-25	89
17-1092-17	83	20-1520-02	94	22-1201-27	89
17-1093-17	83	21-1032-35	95	22-1210-20	90
17-1102-17	83	21-1032-40	95	22-1210-22	90
17-1117-18	83	21-1033-35	95	22-1210-25	90
17-1140-15	82	21-1033-40	95	22-1210-27	90
17-1140-23	82	21-1042-35	95	22-1211-20	90
17-1140-25	82	21-1042-40	95	22-1211-22	90
17-1158-15	83	21-1043-35	95	22-1211-25	90
17-1200-14	82	21-1043-40	95	22-1211-27	90
17-1200-16	82	21-1451-19	147	22-1300-25	89
17-1200-18	82	21-1451-20	147	22-1303-25	89

22-1310-25	89	24-1171-14	102	24-1351-20	106
22-1311-25	89	24-1180-16	103	24-1351-22	106
22-1320-26	88	24-1181-16	103	24-1351-24	106
22-1321-26	89	24-1181-19	103	24-1351-26	106
22-1351-13	88	24-1182-16	103	24-1351-30	106
22-1360-13	88	24-1183-16	103	24-1352-13	105
22-1360-16	88	24-1183-19	104	24-1352-14	105
22-1360-18	88	24-1185-19	104	24-1352-16	105
23-1002-15	91	24-1187-19	104	24-1353-13	105
23-1002-18	91	24-1260-14	106	24-1353-14	105
23-1002-20	91	24-1260-16	106	24-1353-16	105
23-1004-15	91	24-1260-18	106	24-1354-15	103
23-1004-18	91	24-1260-20	106	24-1356-15	103
23-1004-20	91	24-1260-22	106	24-1358-15	97
23-1006-14	91	24-1260-24	106	24-1358-20	97
23-1012-16	91	24-1260-26	106	24-1364-14	97
23-1012-18	91	24-1260-30	106	24-1366-19	97
23-1012-20	91	24-1261-14	106	24-1368-14	99
24-1000-10	99	24-1261-16	106	24-1368-16	99
24-1001-10	99	24-1261-18	106	24-1369-13	98
24-1010-10	98	24-1261-20	106	24-1370-13	96
24-1016-10	98	24-1261-22	106	24-1372-13	96
24-1020-10	101	24-1261-24	106	24-1376-16	96
24-1020-12	101	24-1261-26	106	24-1380-15	102
24-1021-10	101	24-1261-30	106	24-1381-15	102
24-1021-12	101	24-1262-13	105	24-1382-15	102
24-1030-10	101	24-1262-14	105	24-1383-15	102
24-1030-12	101	24-1262-16	105	24-1384-20	106
24-1031-10	101	24-1263-13	105	24-1384-26	106
24-1031-12	101	24-1263-14	105	24-1385-20	106
24-1050-12	100	24-1263-16	105	24-1385-26	106
24-1050-14	100	24-1290-13	99	24-1386-20	106
24-1050-18	100	24-1290-15	99	24-1386-26	106
24-1050-21	100	24-1290-18	99	24-1387-20	106
24-1051-12	100	24-1290-20	99	24-1387-26	106
24-1051-14	100	24-1291-13	99	24-1390-20	107
24-1051-18	100	24-1291-15	99	24-1391-20	107
24-1051-21	100	24-1291-18	99	24-1393-20	107
24-1070-12	100	24-1291-20	99	24-1409-14	108
24-1070-14	100	24-1340-16	105	24-1411-14	108
24-1070-18	100	24-1340-20	105	24-1411-18	108
24-1070-21	100	24-1341-16	105	24-1412-18	104
24-1071-12	100	24-1341-20	105	24-1413-18	104
24-1071-14	100	24-1347-14	102	24-1414-18	104
24-1071-18	100	24-1350-14	106	24-1415-18	104
24-1071-21	100	24-1350-16	106	24-1421-01	110
24-1140-14	100	24-1350-18	106	24-1421-02	110
24-1141-14	100	24-1350-20	106	24-1421-03	110
24-1150-14	101	24-1350-22	106	24-1421-04	110
24-1151-14	101	24-1350-24	106	24-1421-05	110
24-1152-16	101	24-1350-26	106	24-1421-06	110
24-1153-16	101	24-1350-30	106	24-1421-07	110
24-1160-14	102	24-1351-14	106	24-1422-01	110
24-1161-14	102	24-1351-16	106	24-1422-02	110
24-1170-14	102	24-1351-18	106	24-1422-03	110

24-1422-04	110	24-1465-19	111	24-1613-23	122
24-1422-05	110	24-1465-22	111	24-1614-21	121
24-1422-06	110	24-1465-24	111	24-1615-21	121
24-1422-07	110	24-1467-19	111	24-1617-21	121
24-1423-01	109	24-1467-22	111	24-1621-19	121
24-1423-02	109	24-1467-24	111	24-1623-21	121
24-1423-03	109	24-1471-21	108	24-1625-23	120
24-1423-04	109	24-1473-22	113	24-1627-24	120
24-1424-14	102	24-1473-23	113	24-1629-21	120
24-1429-18	112	24-1475-01	99	24-1630-21	119
24-1429-22	112	24-1475-02	99	24-1631-21	119
24-1429-25	112	24-1475-18	108	24-1650-16	98
24-1429-28	112	24-1477-15	113	24-1650-20	98
24-1431-14	112	24-1477-19	113	24-1651-16	98
24-1431-16	112	24-1479-22	114	24-1651-20	98
24-1431-18	112	24-1479-25	114	24-1656-15	98
24-1431-20	112	24-1479-28	114	24-1658-25	97
24-1431-23	112	24-1480-15	105	24-1658-27	97
24-1431-25	112	24-1480-18	105	24-1701-14	118
24-1431-28	112	24-1481-15	105	24-1703-18	118
24-1433-20	112	24-1481-18	105	24-1709-20	118
24-1433-24	112	24-1497-20	108	24-1721-20	119
24-1433-28	112	24-1501-19	114	24-1723-20	119
24-1436-21	114	24-1501-23	114	25-1010-12	124
24-1438-21	114	24-1503-18	114	25-1020-12	124
24-1441-01	109	24-1505-24	115	25-1022-12	124
24-1441-02	109	24-1507-22	115	25-1028-13	124
24-1441-03	109	24-1509-20	116	25-1030-13	124
24-1441-04	109	24-1509-22	116	25-1040-13	124
24-1442-21	111	24-1509-24	116	25-1046-13	124
24-1442-26	111	24-1511-23	116	25-1048-14	124
24-1443-21	111	24-1513-23	116	25-1060-15	125
24-1443-26	111	24-1517-23	117	25-1070-15	125
24-1444-21	111	24-1523-22	115	25-1072-17	125
24-1444-26	111	24-1523-23	115	25-1080-14	126
24-1445-21	111	24-1525-22	115	25-1080-16	126
24-1445-26	111	24-1525-23	115	25-1080-18	126
24-1448-22	107	24-1529-21	114	25-1080-20	126
24-1449-22	107	24-1533-01	107	25-1080-24	126
24-1450-24	107	24-1533-02	107	25-1080-26	126
24-1451-24	107	24-1540-19	103	25-1080-30	126
24-1453-24	104	24-1541-19	103	25-1090-16	126
24-1455-01	113	24-1543-19	112	25-1090-18	126
24-1455-02	113	24-1543-21	112	25-1090-20	126
24-1456-22	115	24-1543-24	112	25-1096-13	125
24-1456-23	115	24-1601-24	119	25-1110-15	126
24-1456-24	115	24-1602-25	119	25-1141-21	127
24-1457-28	114	24-1603-23	120	25-1148-23	127
24-1459-18	113	24-1605-23	120	25-1150-27	127
24-1459-28	113	24-1606-20	120	25-1160-27	127
24-1461-15	113	24-1606-25	120	25-1190-18	125
24-1461-19	113	24-1607-21	121	25-1192-18	125
24-1463-19	111	24-1611-21	122	25-1193-27	127
24-1463-22	111	24-1611-23	122	25-1211-27	127
24-1463-24	111	24-1613-21	122	25-1230-23	128

25-1306-14	128	26-1080-30	135	26-1350-20	141
25-1310-14	128	26-1084-20	139	26-1356-17	142
25-1310-17	128	26-1084-24	139	26-1356-20	142
25-1310-18	128	26-1090-14	138	26-1356-23	142
25-1350-14	129	26-1090-18	138	26-1358-14	141
25-1350-17	129	26-1090-20	138	26-1358-17	141
25-1350-20	129	26-1090-23	138	26-1358-20	141
25-1354-14	129	26-1114-18	136	26-1360-18	143
25-1354-17	129	26-1114-20	136	26-1360-20	143
25-1356-17	129	26-1114-23	136	26-1360-23	143
25-1356-20	129	26-1114-26	136	26-1362-18	140
25-1358-14	130	26-1114-31	136	26-1364-20	143
25-1358-17	130	26-1114-37	136	26-1364-23	143
25-1358-20	130	26-1132-13	136	26-1366-17	142
25-1362-18	128	26-1132-15	136	26-1366-20	142
25-1366-20	129	26-1132-18	136	26-1390-18	144
25-1550-10	130	26-1132-20	136	26-1428-14	133
25-1551-10	130	26-1132-23	136	26-1560-14	144
25-1553-10	130	26-1132-26	136	26-1561-14	144
25-1553-13	130	26-1134-13	137	26-1562-14	144
25-1570-14	131	26-1134-15	137	26-1563-14	144
25-1570-18	131	26-1134-18	137	26-1570-14	144
25-1571-14	131	26-1134-20	137	26-1570-18	144
25-1571-18	131	26-1134-23	137	26-1571-14	144
25-1576-14	131	26-1134-26	137	26-1571-18	144
25-1576-18	131	26-1136-15	137	26-1576-14	144
25-1577-14	131	26-1136-17	137	26-1576-18	144
25-1577-18	131	26-1136-20	137	26-1577-14	144
25-1600-18	131	26-1141-20	135	26-1577-18	144
25-1601-14	130	26-1141-24	135	27-1211-01	145
25-1601-18	131	26-1141-26	135	27-1211-02	145
25-1621-13	130	26-1150-27	138	27-1211-03	145
25-1630-18	131	26-1160-27	138	27-1211-04	145
25-1631-18	131	26-1185-20	139	27-1221-01	145
25-1650-14	132	26-1185-24	139	27-1221-02	145
25-1651-14	132	26-1185-26	139	27-1221-03	145
25-1653-14	132	26-1211-27	138	27-1221-04	145
25-1661-14	132	26-1224-18	134	27-1223-01	145
25-1663-14	132	26-1224-20	134	27-1223-02	145
25-1671-13	132	26-1224-26	134	27-1223-03	145
25-1673-13	132	26-1230-22	140	27-1223-04	145
26-1010-12	133	26-1230-23	140	27-1320-20	146
26-1028-13	133	26-1240-15	139	27-1321-20	146
26-1029-13	133	26-1242-20	139	27-1322-20	146
26-1030-13	134	26-1250-16	133	27-1323-20	146
26-1040-13	134	26-1250-18	133	27-1324-21	147
26-1048-12	133	26-1250-20	133	27-1324-27	147
26-1048-14	133	26-1250-23	133	27-1325-21	147
26-1060-15	134	26-1250-26	133	27-1325-27	147
26-1060-18	134	26-1310-14	140	27-1328-20	146
26-1080-16	135	26-1310-17	140	27-1329-20	146
26-1080-18	135	26-1310-18	140	27-1330-20	146
26-1080-20	135	26-1330-16	140	27-1331-20	146
26-1080-24	135	26-1350-14	141	27-1332-21	147
26-1080-26	135	26-1350-17	141	27-1332-27	147

27-1333-21	147	27-1553-14	154	28-1103-03	160
27-1333-27	147	27-1555-01	154	28-1103-04	160
27-1450-20	147	27-1556-12	154	28-1111-01	161
27-1451-19	147	27-1558-00	155	28-1111-02	161
27-1451-20	147	27-1558-12	155	28-1111-03	161
27-1452-01	148	27-1559-10	155	28-1111-04	161
27-1452-02	148	27-1560-01	155	28-1112-01	161
27-1452-03	148	27-1560-02	155	28-1112-02	161
27-1454-01	148	27-1570-08	155	28-1112-03	161
27-1454-02	148	27-1570-11	155	28-1112-04	161
27-1455-25	148	27-1570-12	155	28-1140-01	161
27-1458-21	148	27-1570-14	155	28-1140-02	161
27-1460-01	149	27-1570-16	155	28-1150-01	162
27-1460-02	149	27-1570-18	155	28-1150-02	162
27-1460-03	149	27-1570-20	155	28-1150-03	162
27-1460-24	149	27-1570-22	155	28-1150-04	162
27-1467-01	149	28-1050-01	158	28-1150-05	162
27-1467-02	149	28-1050-02	158	28-1150-06	162
27-1468-15	149	28-1054-15	158	28-1160-10	162
27-1469-14	149	28-1058-01	158	28-1160-20	162
27-1470-01	149	28-1058-02	158	28-1162-01	161
27-1470-02	150	28-1058-03	158	28-1162-02	161
27-1472-23	150	28-1060-13	158	28-1164-01	162
27-1473-23	150	28-1062-16	158	28-1164-02	162
27-1474-01	150	28-1070-01	159	28-1164-03	162
27-1474-02	150	28-1070-02	159	28-1164-04	162
27-1477-24	150	28-1070-03	159	28-1166-16	162
27-1480-01	150	28-1070-04	159	28-1170-14	163
27-1480-02	150	28-1074-16	158	28-1174-15	163
27-1481-23	150	28-1078-01	158	28-1178-15	163
27-1500-01	151	28-1078-02	158	28-1179-15	163
27-1500-02	151	28-1080-01	159	28-1180-16	163
27-1500-03	151	28-1080-02	159	28-1181-16	163
27-1500-04	151	28-1082-01	160	28-1200-08	164
27-1502-22	152	28-1082-02	160	28-1200-10	164
27-1503-22	152	28-1086-01	159	28-1200-12	164
27-1506-19	152	28-1086-02	159	28-1200-14	164
27-1507-19	152	28-1086-03	159	28-1200-16	164
27-1508-03	152	28-1086-04	159	28-1200-18	164
27-1508-05	152	28-1088-02	160	28-1204-08	164
27-1508-07	152	28-1088-03	160	28-1204-10	164
27-1510-25	153	28-1088-04	160	28-1204-12	164
27-1510-28	153	28-1089-02	160	28-1204-14	164
27-1513-15	153	28-1089-03	160	28-1204-16	164
27-1513-16	153	28-1089-04	160	28-1204-18	164
27-1514-15	153	28-1101-01	160	28-1210-08	165
27-1514-16	153	28-1101-02	160	28-1210-10	165
27-1516-18	153	28-1101-03	160	28-1210-12	165
27-1521-18	153	28-1101-04	160	28-1210-14	165
27-1521-27	153	28-1102-01	160	28-1210-16	165
27-1530-23	154	28-1102-02	160	28-1210-18	165
27-1531-21	154	28-1102-03	160	28-1212-08	165
27-1532-23	154	28-1102-04	160	28-1212-10	165
27-1550-12	154	28-1103-01	160	28-1212-12	165
27-1552-13	154	28-1103-02	160	28-1212-14	165

28-1212-16	165	29-1012-01	172	29-1182-02	177
28-1212-18	165	29-1012-02	172	29-1182-03	177
28-1220-08	166	29-1012-03	172	29-1192-01	178
28-1220-11	166	29-1012-04	172	29-1192-02	178
28-1220-13	166	29-1012-06	172	29-1192-03	178
28-1220-17	166	29-1012-08	172	29-1200-00	178
28-1220-20	166	29-1013-01	172	29-1200-01	178
28-1220-23	166	29-1013-02	172	29-1200-02	178
28-1230-08	166	29-1013-03	172	29-1210-02	177
28-1230-11	166	29-1013-04	172	29-1210-03	177
28-1230-13	166	29-1013-06	172	29-1210-04	177
28-1230-17	166	29-1013-08	172	29-1210-05	177
28-1230-20	166	29-1021-24	173	29-1210-06	177
28-1230-23	166	29-1022-24	173	29-1210-07	177
28-1300-12	167	29-1032-04	173	29-1220-01	179
28-1302-15	167	29-1032-05	173	29-1220-02	179
28-1310-00	167	29-1032-06	173	29-1220-03	179
28-1310-01	167	29-1032-07	173	29-1230-50	178
28-1310-02	167	29-1100-55	173	29-1240-40	178
28-1310-03	167	29-1100-60	173	29-1240-50	178
28-1310-04	167	29-1100-63	173	29-1240-60	178
28-1340-06	168	29-1110-30	174	29-1240-75	178
28-1342-13	168	29-1110-31	174	29-1240-85	178
28-1350-00	168	29-1110-32	174	29-1250-70	179
28-1360-00	168	29-1110-40	174	29-1250-81	179
28-1370-16	169	29-1110-50	174	29-1250-82	179
28-1370-20	169	29-1120-30	174	29-1250-83	179
28-1370-25	169	29-1120-31	174	29-1260-01	180
28-1380-00	168	29-1120-32	174	29-1260-02	180
28-1390-00	169	29-1120-40	174	29-1272-90	181
28-1396-19	169	29-1120-50	174	29-1274-01	181
29-1001-01	170	29-1130-22	175	29-1274-02	181
29-1001-02	170	29-1130-25	175	29-1274-03	181
29-1001-03	170	29-1130-26	175	29-1280-61	180
29-1001-04	170	29-1130-35	175	29-1280-62	180
29-1001-06	170	29-1130-36	175	29-1280-91	180
29-1001-08	170	29-1130-37	175	29-1280-92	180
29-1002-01	171	29-1130-40	175	29-1290-38	181
29-1002-02	171	29-1130-70	175	29-1290-51	181
29-1002-03	171	29-1130-80	175	29-1320-25	182
29-1002-04	171	29-1130-85	175	29-1320-26	182
29-1002-06	171	29-1140-18	176	29-1320-27	182
29-1002-08	171	29-1140-20	176	29-1350-16	183
29-1003-01	170	29-1140-25	176	29-1350-25	183
29-1003-02	170	29-1140-30	176	29-1350-50	183
29-1003-03	170	29-1140-40	176	29-1360-08	183
29-1003-04	170	29-1150-44	176	29-1360-10	183
29-1003-06	170	29-1150-55	176	29-1360-12	183
29-1003-08	170	29-1150-72	176	29-1360-14	183
29-1011-01	171	29-1160-19	179	29-1360-16	183
29-1011-02	171	29-1164-20	180	29-1360-18	183
29-1011-03	171	29-1180-01	177	29-1370-08	184
29-1011-04	171	29-1180-02	177	29-1370-10	184
29-1011-06	171	29-1180-03	177	29-1370-12	184
29-1011-08	171	29-1182-01	177	29-1370-14	184

29-1370-16	184	30-1621-10	188	30-1871-04	194
29-1370-18	184	30-1622-07	188	31-1310-01	200
29-1390-01	182	30-1622-10	188	31-1310-02	200
29-1390-02	182	30-1626-09	188	31-1310-03	200
29-1390-03	182	30-1630-10	188	31-1310-28	198
29-1500-40	182	30-1631-10	188	31-1312-30	198
29-1500-62	182	30-1650-10	191	31-1330-24	199
29-1600-25	186	30-1651-10	191	31-1331-01	200
29-1600-38	186	30-1660-14	189	31-1331-02	200
29-1600-50	186	30-1661-14	189	31-1331-03	200
29-1600-75	186	30-1670-13	191	31-1332-24	199
29-1602-18	184	30-1670-16	191	31-1334-24	199
29-1602-22	184	30-1670-20	191	31-1360-01	200
29-1602-23	184	30-1670-24	192	31-1360-02	200
29-1604-30	185	30-1671-13	191	31-1360-03	200
29-1604-33	185	30-1671-16	191	31-1360-27	199
29-1604-36	185	30-1671-20	191	31-1398-01	200
29-1610-38	185	30-1671-24	192	31-1398-02	200
29-1610-50	185	30-1672-11	192	31-1398-03	200
29-1610-75	185	30-1673-11	192	31-1398-10	200
29-1700-30	186	30-1674-15	190	31-1398-11	200
29-1700-32	186	30-1678-20	189	31-1398-12	200
29-1710-50	186	30-1679-20	189	31-1398-13	200
29-1710-90	186	30-1682-26	189	31-1399-01	200
29-1720-01	186	30-1683-26	189	31-1399-02	200
29-1720-02	186	30-1684-16	189	31-1399-03	200
29-1721-01	186	30-1685-16	189	31-1399-10	200
29-1721-02	186	30-1690-31	194	31-1399-13	200
30-1202-14	193	30-1691-32	195	31-1399-14	200
30-1202-19	193	30-1800-12	190	31-1399-23	200
30-1240-10	195	30-1801-12	190	31-1399-33	200
30-1240-14	195	30-1810-10	190	31-1400-10	201
30-1250-19	193	30-1810-13	190	31-1412-14	201
30-1300-00	197	30-1810-15	190	31-1414-16	201
30-1300-16	197	30-1810-18	190	31-1450-12	201
30-1300-19	197	30-1811-10	190	31-1610-00	203
30-1300-25	197	30-1811-13	190	31-1610-01	203
30-1300-32	197	30-1811-15	190	31-1760-09	203
30-1301-00	197	30-1811-18	190	31-1764-18	202
30-1301-16	197	30-1822-17	190	31-1768-20	202
30-1320-17	198	30-1830-13	192	31-1768-25	202
30-1330-18	198	30-1831-13	192	31-1772-01	202
30-1330-23	198	30-1840-13	192	31-1772-02	202
30-1330-30	198	30-1850-13	193	31-1772-25	202
30-1401-22	196	30-1860-20	193	31-1798-01	203
30-1411-17	196	30-1860-26	193	31-1798-02	203
30-1420-17	196	30-1861-20	193	31-1798-03	203
30-1430-15	196	30-1861-26	193	31-1799-70	203
30-1610-05	188	30-1870-01	194	31-1850-18	203
30-1610-07	188	30-1870-02	194	31-1850-23	203
30-1611-05	188	30-1870-03	194	31-1850-30	203
30-1611-07	188	30-1870-04	194	31-1850-45	203
30-1620-07	188	30-1871-01	194	31-1859-01	204
30-1620-10	188	30-1871-02	194	31-1859-02	204
30-1621-07	188	30-1871-03	194	31-1859-03	204

31-1859-04	204	31-1920-16	209	33-1130-01	215
31-1859-05	204	31-1920-20	209	33-1130-02	215
31-1859-06	204	32-1170-13	210	33-1130-03	215
31-1859-07	204	32-1170-25	210	33-1130-04	215
31-1859-08	204	32-1170-32	210	33-1135-01	256
31-1859-09	204	32-1170-40	210	33-1135-02	256
31-1860-00	205	32-1170-50	210	33-1135-03	256
31-1860-01	205	32-1200-01	210	33-1150-00	217
31-1860-11	205	32-1200-02	210	33-1150-01	217
31-1860-22	205	32-1200-03	210	33-1150-03	217
31-1870-00	205	32-1210-06	210	33-1150-06	217
31-1870-01	205	32-1210-12	210	33-1150-09	217
31-1870-11	205	32-1210-17	210	33-1150-12	217
31-1870-12	205	32-1210-20	210	33-1150-20	217
31-1880-00	206	32-1210-25	210	33-1150-21	217
31-1880-01	206	32-1220-20	210	33-1150-22	217
31-1880-02	206	32-1230-28	210	33-1260-16	216
31-1880-03	206	33-1000-11	214	33-1262-18	216
31-1880-11	207	33-1000-13	214	33-1264-28	216
31-1880-12	207	33-1000-14	214	33-1270-12	216
31-1880-13	206	33-1000-16	214	33-1270-14	216
31-1880-14	206	33-1000-18	214	33-1270-16	216
31-1880-15	206	33-1000-20	214	33-1270-18	216
31-1880-16	206	33-1004-11	214	33-1271-12	216
31-1880-17	206	33-1004-13	214	33-1271-14	216
31-1880-20	207	33-1004-14	214	33-1271-16	216
31-1880-21	207	33-1004-16	214	33-1271-18	216
31-1882-00	206	33-1004-18	214	34-1100-03	218
31-1882-01	206	33-1004-20	214	34-1100-04	218
31-1884-00	207	33-1013-11	214	34-1102-03	219
31-1884-01	207	33-1013-13	214	34-1102-04	219
31-1890-00	208	33-1013-14	214	34-1110-30	218
31-1890-01	208	33-1013-16	214	34-1110-35	218
31-1890-11	208	33-1013-18	214	34-1110-40	218
31-1890-12	208	33-1013-20	214	34-1110-45	218
31-1890-13	208	33-1027-11	214	34-1110-50	218
31-1890-14	208	33-1027-13	214	34-1110-55	218
31-1890-15	208	33-1027-14	214	34-1110-60	218
31-1900-00	208	33-1027-16	214	34-1112-30	218
31-1900-01	208	33-1027-18	214	34-1112-35	218
31-1900-11	208	33-1027-20	214	34-1112-40	218
31-1900-12	208	33-1033-10	214	34-1112-45	218
31-1900-13	208	33-1110-11	215	34-1112-50	218
31-1900-14	208	33-1110-13	215	34-1112-55	218
31-1910-11	209	33-1110-14	215	34-1112-60	218
31-1910-12	209	33-1110-16	215	34-1114-30	218
31-1910-13	209	33-1110-18	215	34-1114-35	218
31-1910-14	209	33-1110-20	215	34-1114-40	218
31-1915-30	209	33-1117-14	214	34-1114-45	218
31-1920-01	209	33-1120-16	214	34-1114-50	218
31-1920-02	209	33-1122-13	215	34-1114-55	218
31-1920-10	209	33-1122-14	215	34-1114-60	218
31-1920-11	209	33-1122-16	215	34-1118-07	218
31-1920-12	209	33-1122-18	215	34-1118-09	218
31-1920-13	209	33-1126-20	214	34-1118-12	218

34-1120-01	220	35-1033-12	223	36-1210-12	225
34-1120-02	220	35-1034-06	223	36-1210-15	225
34-1120-03	220	35-1034-08	223	36-1230-14	226
34-1120-04	220	35-1034-10	223	36-1230-18	226
34-1124-24	219	35-1034-12	223	36-1650-16	225
34-1128-06	220	35-1050-21	223	36-1650-20	225
34-1128-08	220	35-1060-01	223	37-1000-01	227
34-1130-20	220	35-1060-02	223	37-1000-02	227
34-1130-25	220	35-1060-03	223	37-1000-05	227
34-1130-30	220	35-1060-04	223	37-1000-10	227
34-1140-01	220	36-1000-01	224	37-1000-20	227
34-1140-02	220	36-1000-02	224	37-1000-50	227
34-1140-03	220	36-1000-03	224	37-1001-01	227
34-1140-04	220	36-1000-04	224	37-1001-02	227
34-1160-16	219	36-1000-05	224	37-1001-05	227
34-1161-16	219	36-1000-06	224	37-1001-10	227
34-1164-18	219	36-1000-07	224	37-1001-20	227
34-1170-00	221	36-1060-16	225	37-1001-50	227
34-1172-00	221	36-1090-12	226	37-1050-01	227
34-1175-00	221	36-1090-14	226	37-1050-02	227
34-1180-30	220	36-1090-16	226	37-1050-05	227
34-1180-40	220	36-1115-01	226	37-1050-10	227
34-1180-50	220	36-1115-02	226	37-1050-20	227
34-1184-30	221	36-1115-03	226	37-1050-50	227
34-1184-40	221	36-1115-04	226	37-1051-01	227
34-1184-50	221	36-1115-05	226	37-1051-02	227
34-1184-55	221	36-1115-06	226	37-1051-05	227
34-1190-14	220	36-1115-07	226	37-1051-10	227
35-1000-27	222	36-1115-08	226	37-1051-20	227
35-1006-24	222	36-1117-14	226	37-1051-50	227
35-1007-26	222	36-1117-18	226	37-1055-02	227
35-1008-27	222	36-1120-01	226	37-1055-05	227
35-1010-17	222	36-1120-02	226	37-1055-10	227
35-1010-35	222	36-1120-03	226	37-1060-01	227
35-1012-15	223	36-1120-04	226	37-1060-02	227
35-1012-25	223	36-1120-05	226	37-1061-01	227
35-1012-35	223	36-1120-06	226	37-1061-02	227
35-1014-23	222	36-1120-07	226	37-1065-01	228
35-1016-22	223	36-1130-01	225	37-1066-01	228
35-1020-06	221	36-1130-02	225	37-1070-05	228
35-1020-10	221	36-1130-03	225	37-1070-10	228
35-1021-06	221	36-1130-04	225	37-1070-15	228
35-1021-08	221	36-1130-05	225	37-1070-20	228
35-1024-00	222	36-1130-06	225	37-1071-05	228
35-1024-01	222	36-1130-07	225	37-1071-10	228
35-1024-02	222	36-1140-03	224	37-1071-15	228
35-1024-03	222	36-1140-04	224	37-1071-20	228
35-1024-04	222	36-1140-05	224	37-1080-10	228
35-1030-06	223	36-1140-06	224	37-1080-20	228
35-1030-08	223	36-1150-01	224	37-1080-30	228
35-1030-10	223	36-1150-14	224	37-1080-50	228
35-1030-12	223	36-1180-10	225	37-1081-10	228
35-1033-06	223	36-1180-12	225	37-1081-20	228
35-1033-08	223	36-1180-15	225	37-1081-30	228
35-1033-10	223	36-1200-06	224	37-1081-50	228

37-1100-50	228	50-1072-01	234	52-1178-16	242
37-1911-00	229	50-1074-01	234	52-1178-20	242
37-1912-06	229	50-1074-02	234	52-1200-18	245
37-1912-08	229	50-1076-34	234	52-1201-18	245
37-1913-00	229	50-1078-32	235	52-1210-21	245
37-1920-00	229	50-1080-01	234	52-1210-23	245
37-1922-00	229	50-1080-02	234	52-1211-21	245
37-1926-00	229	50-1080-03	234	52-1211-23	245
37-1930-02	229	50-1080-04	234	52-1230-21	247
37-1935-00	229	50-1080-05	234	52-1230-23	247
37-1939-00	229	50-1080-06	234	52-1230-25	247
47-1100-01	211	50-1080-07	234	52-1231-21	247
47-1100-02	211	50-1080-08	234	52-1231-23	247
47-1100-03	211	50-1082-35	235	52-1231-25	247
47-1100-04	211	50-1084-30	235	52-1234-22	246
47-1150-01	211	51-1001-01	232	52-1234-25	246
48-1001-22	117	51-1001-02	232	52-1234-28	246
48-1002-01	118	51-1001-03	232	52-1235-22	246
48-1002-02	118	51-1001-04	232	52-1235-25	246
48-1003-01	118	51-1001-05	232	52-1235-28	246
48-1003-02	118	51-1001-06	232	52-1240-24	248
48-1004-20	117	51-1519-23	116	52-1253-23	248
48-1005-20	117	51-1519-24	116	52-1259-23	248
50-1001-01	232	52-1000-12	242	52-1310-15	249
50-1001-02	232	52-1000-15	242	52-1310-21	249
50-1005-20	233	52-1004-15	242	52-1310-29	249
50-1006-20	233	52-1004-19	242	52-1311-15	249
50-1008-20	232	52-1004-25	242	52-1311-21	249
50-1009-20	232	52-1006-16	244	52-1311-29	249
50-1021-22	232	52-1006-18	244	52-1320-05	249
50-1031-01	233	52-1006-20	244	52-1320-07	249
50-1031-03	233	52-1006-24	244	52-1320-10	249
50-1037-24	233	52-1010-15	243	52-1325-26	249
50-1039-24	233	52-1012-15	243	52-1340-08	249
50-1050-01	236	52-1014-20	243	52-1360-30	250
50-1050-02	236	52-1020-15	242	52-1361-30	250
50-1050-03	236	52-1020-20	242	52-1364-33	250
50-1050-04	236	52-1020-23	242	52-1365-33	250
50-1050-05	236	52-1030-12	242	53-1006-16	244
50-1050-06	236	52-1030-15	242	53-1006-20	244
50-1050-07	236	52-1030-19	242	53-1170-20	244
50-1050-08	236	52-1040-15	243	54-1006-16	244
50-1050-09	236	52-1040-19	243	54-1006-20	244
50-1050-10	236	52-1050-20	243	54-1210-21	246
50-1050-11	236	52-1060-16	243	54-1210-23	246
50-1050-12	236	52-1070-16	243	54-1211-21	246
50-1050-13	236	52-1124-16	242	54-1211-23	246
50-1056-13	235	52-1124-20	242	54-1230-21	248
50-1056-18	235	52-1124-25	242	54-1230-23	248
50-1056-21	235	52-1124-30	242	54-1230-25	248
50-1058-18	235	52-1169-20	244	54-1231-21	248
50-1058-21	235	52-1170-18	245	54-1231-23	248
50-1058-24	235	52-1170-20	245	54-1231-25	248
50-1058-26	235	52-1172-20	245	54-1234-22	247
50-1070-01	234	52-1172-23	245	54-1234-25	247

54-1234-28	247	55-1405-12	255	56-1660-16	240
54-1235-22	247	55-1410-00	255	56-1660-18	240
54-1235-25	247	55-1471-19	256	56-1660-20	240
54-1235-28	247	55-1473-19	256	56-1660-24	240
54-1240-24	248	56-1055-01	117	57-1090-03	269
55-1000-02	254	56-1055-02	117	57-1090-04	269
55-1010-19	251	56-1071-24	238	57-1090-05	269
55-1020-26	251	56-1073-23	238	57-1092-03	269
55-1020-28	251	56-1075-23	238	57-1092-04	269
55-1108-15	252	56-1077-24	238	57-1092-05	269
55-1110-15	252	56-1080-20	238	57-1096-25	269
55-1124-25	254	56-1080-28	238	57-1100-01	260
55-1124-29	254	56-1150-24	238	57-1100-02	260
55-1124-38	254	56-1160-00	237	57-1100-03	260
55-1147-00	253	56-1172-00	237	57-1120-01	260
55-1147-02	253	56-1176-00	237	57-1120-02	260
55-1147-03	253	56-1176-01	237	57-1120-03	260
55-1147-75	253	56-1176-02	237	57-1130-01	258
55-1147-95	253	56-1176-03	237	57-1130-02	258
55-1150-21	252	56-1176-04	237	57-1130-03	258
55-1160-15	252	56-1182-00	237	57-1132-00	258
55-1200-00	253	56-1230-21	239	57-1134-00	258
55-1212-01	253	56-1236-22	239	57-1140-00	259
55-1212-02	253	56-1238-21	239	57-1140-01	259
55-1212-03	253	56-1240-22	239	57-1140-02	259
55-1212-04	253	56-1250-26	239	57-1140-03	259
55-1220-01	254	56-1257-23	239	57-1142-01	258
55-1220-02	254	56-1345-08	240	57-1142-02	258
55-1220-03	254	56-1349-11	240	57-1142-03	258
55-1220-04	254	56-1350-08	240	57-1142-04	258
55-1220-05	254	56-1350-11	240	57-1142-05	258
55-1220-06	254	56-1350-13	240	57-1142-06	258
55-1250-22	254	56-1350-16	240	57-1144-01	259
55-1250-30	254	56-1350-21	240	57-1144-02	259
55-1268-01	254	56-1350-26	240	57-1144-03	259
55-1268-02	254	56-1350-32	240	57-1146-01	259
55-1280-01	253	56-1650-08	240	57-1146-02	259
55-1280-02	253	56-1650-10	240	57-1146-03	259
55-1280-03	253	56-1650-12	240	57-1150-01	260
55-1280-04	253	56-1650-14	240	57-1150-02	260
55-1280-05	253	56-1650-16	240	57-1150-03	260
55-1280-06	253	56-1650-18	240	57-1160-00	260
55-1300-28	255	56-1650-20	240	57-1170-00	261
55-1300-35	255	56-1650-22	240	57-1172-00	261
55-1300-42	255	56-1650-24	240	57-1180-00	261
55-1301-28	255	56-1660-06	240	57-1180-03	261
55-1301-35	255	56-1660-07	240	57-1180-04	261
55-1301-42	255	56-1660-08	240	57-1180-05	261
55-1311-28	255	56-1660-09	240	57-1180-06	261
55-1311-35	255	56-1660-10	240	57-1180-07	261
55-1311-42	255	56-1660-11	240	57-1180-08	261
55-1312-28	255	56-1660-12	240	57-1180-40	261
55-1312-35	255	56-1660-13	240	57-1180-80	261
55-1312-42	255	56-1660-14	240	57-1220-01	262
55-1400-00	255	56-1660-15	240	57-1220-02	262

57-1220-03	262	57-1270-02	265	57-1350-07	270
57-1221-01	262	57-1271-01	265	57-1350-08	270
57-1221-02	262	57-1271-02	265	57-1350-09	270
57-1221-03	262	57-1272-01	265	57-1350-10	270
57-1222-01	262	57-1272-02	265	57-1350-11	270
57-1222-02	262	57-1275-17	265	57-1350-12	270
57-1222-03	262	57-1290-01	265	57-1350-13	270
57-1230-01	262	57-1290-02	265	57-1350-14	270
57-1230-02	262	57-1290-03	265	57-1350-15	270
57-1230-03	262	57-1290-17	265	57-1350-16	270
57-1231-01	262	57-1292-01	266	57-1350-17	270
57-1231-02	262	57-1292-02	266	57-1350-18	270
57-1231-03	262	57-1292-03	266	57-1350-19	270
57-1232-01	262	57-1292-04	266	57-1350-20	270
57-1232-02	262	57-1294-00	267	57-1350-21	270
57-1232-03	262	57-1294-01	267	57-1350-22	270
57-1234-00	263	57-1294-02	267	57-1350-23	270
57-1234-01	263	57-1294-03	267	57-1350-24	270
57-1234-02	263	57-1300-01	267	57-1350-25	270
57-1234-03	263	57-1300-02	267	57-1350-26	270
57-1235-00	263	57-1301-01	267	57-1350-98	270
57-1235-01	263	57-1301-02	267	57-1350-99	270
57-1235-02	263	57-1305-01	267	57-1351-01	270
57-1235-03	263	57-1305-02	267	57-1351-02	270
57-1236-00	263	57-1307-20	268	57-1351-03	270
57-1236-01	263	57-1307-25	268	57-1351-04	270
57-1236-02	263	57-1307-30	268	57-1351-05	270
57-1236-03	263	57-1307-35	268	57-1351-06	270
57-1237-01	263	57-1307-40	268	57-1351-07	270
57-1237-02	263	57-1308-20	268	57-1351-08	270
57-1238-01	263	57-1308-25	268	57-1351-09	270
57-1238-02	263	57-1308-30	268	57-1351-10	270
57-1239-01	263	57-1308-35	268	57-1351-11	270
57-1239-02	263	57-1308-40	268	57-1351-12	270
57-1260-01	264	57-1309-40	268	57-1351-13	270
57-1260-02	264	57-1310-20	268	57-1351-14	270
57-1260-03	264	57-1311-10	268	57-1351-15	270
57-1261-01	264	57-1311-20	268	57-1351-16	270
57-1261-02	264	57-1311-25	268	57-1351-17	270
57-1261-03	264	57-1312-15	268	57-1354-01	271
57-1261-04	264	57-1312-20	268	57-1354-03	271
57-1262-01	264	57-1312-25	268	57-1354-05	271
57-1262-02	264	57-1312-30	268	57-1354-07	271
57-1262-03	264	57-1312-35	268	57-1354-09	271
57-1262-04	264	57-1312-40	268	57-1354-11	271
57-1264-01	264	57-1313-19	268	57-1354-13	271
57-1264-02	264	57-1315-23	268	57-1354-15	271
57-1264-03	264	57-1315-25	268	57-1354-17	271
57-1265-01	264	57-1317-30	268	57-1354-19	271
57-1265-02	264	57-1350-01	270	57-1354-21	271
57-1265-03	264	57-1350-02	270	57-1354-23	271
57-1266-01	264	57-1350-03	270	57-1354-25	271
57-1266-02	264	57-1350-04	270	57-1354-98	271
57-1266-03	264	57-1350-05	270	57-1354-99	271
57-1270-01	265	57-1350-06	270	57-1360-05	271

57-1360-06	271	57-1529-28	277	57-1700-19	280
57-1360-07	271	57-1530-00	269	57-1700-20	280
57-1360-08	271	57-1530-01	269	57-1700-21	280
57-1360-09	271	57-1530-02	269	57-1700-23	280
57-1360-10	271	57-1540-30	278	57-1701-05	280
57-1360-98	271	57-1542-30	278	57-1701-06	280
57-1370-05	272	57-1543-30	278	57-1701-07	280
57-1370-06	272	57-1550-04	278	57-1701-08	280
57-1370-08	272	57-1552-04	278	57-1701-09	280
57-1370-09	272	57-1560-04	278	57-1701-11	280
57-1370-10	272	57-1560-06	278	57-1701-12	280
57-1370-12	272	57-1560-09	278	57-1701-14	280
57-1370-13	272	57-1570-25	279	57-1701-15	280
57-1370-14	272	57-1572-25	279	57-1701-16	280
57-1370-98	272	57-1574-22	279	57-1701-19	280
57-1400-25	273	57-1576-01	279	57-1701-20	280
57-1402-26	273	57-1576-02	279	57-1701-21	280
57-1404-25	273	57-1576-03	279	57-1701-23	280
57-1410-18	272	57-1576-04	279	57-1702-05	281
57-1412-19	272	57-1576-05	279	57-1702-06	281
57-1414-17	272	57-1580-27	279	57-1702-07	281
57-1417-20	273	57-1583-14	279	57-1702-08	281
57-1419-28	273	57-1588-01	279	57-1702-09	281
57-1421-24	273	57-1588-02	279	57-1702-11	281
57-1423-24	274	57-1602-25	287	57-1702-12	281
57-1426-24	274	57-1604-20	287	57-1702-14	281
57-1429-24	274	57-1608-28	287	57-1702-15	281
57-1431-23	274	57-1610-04	287	57-1702-16	281
57-1434-21	274	57-1610-06	287	57-1702-19	281
57-1435-21	274	57-1614-23	287	57-1702-20	281
57-1440-06	275	57-1615-23	287	57-1702-21	281
57-1440-08	275	57-1630-10	288	57-1702-23	281
57-1440-10	275	57-1630-12	288	57-1703-05	281
57-1441-06	275	57-1630-14	288	57-1703-06	281
57-1441-08	275	57-1630-40	288	57-1703-07	281
57-1441-10	275	57-1630-41	288	57-1703-08	281
57-1442-15	275	57-1630-50	288	57-1703-09	281
57-1444-20	275	57-1680-22	286	57-1703-11	281
57-1446-28	275	57-1680-24	286	57-1703-12	281
57-1449-26	275	57-1682-21	286	57-1703-14	281
57-1470-20	276	57-1682-29	286	57-1703-15	281
57-1472-27	276	57-1684-24	286	57-1703-16	281
57-1475-32	276	57-1686-24	287	57-1703-19	281
57-1480-25	276	57-1688-21	287	57-1703-20	281
57-1482-27	276	57-1690-26	287	57-1703-21	281
57-1485-23	276	57-1700-05	280	57-1703-23	281
57-1488-25	277	57-1700-06	280	57-1710-05	282
57-1500-26	277	57-1700-07	280	57-1710-06	282
57-1502-28	277	57-1700-08	280	57-1710-07	282
57-1510-32	277	57-1700-09	280	57-1710-08	282
57-1511-32	277	57-1700-11	280	57-1710-09	282
57-1516-32	277	57-1700-12	280	57-1710-11	282
57-1518-32	277	57-1700-14	280	57-1710-12	282
57-1521-25	277	57-1700-15	280	57-1710-14	282
57-1527-29	277	57-1700-16	280	57-1710-15	282

57-1710-16	282	57-1722-40	285	59-1110-05	294
57-1710-19	282	57-1723-30	285	59-1200-02	294
57-1710-20	282	57-1723-35	285	59-1200-03	294
57-1710-21	282	57-1723-40	285	59-1200-04	294
57-1710-23	282	57-1750-27	286	59-1200-05	294
57-1711-05	282	57-1760-01	286	59-1200-06	294
57-1711-06	282	57-1760-02	286	59-1200-07	294
57-1711-07	282	57-1760-03	286	59-1200-08	294
57-1711-08	282	57-1760-04	286	59-1210-00	294
57-1711-09	282	57-1760-05	286	59-1400-00	294
57-1711-11	282	57-1760-06	286	59-1400-01	294
57-1711-12	282	58-1034-30	289	59-1400-02	294
57-1711-14	282	58-1036-33	289	59-1400-03	294
57-1711-15	282	58-1036-36	289	59-1420-01	296
57-1711-16	282	58-1044-36	290	59-1420-17	296
57-1711-19	282	58-1046-36	289	59-1430-01	296
57-1711-20	282	58-1052-41	290	59-1430-16	296
57-1711-21	282	58-1054-40	290	59-1500-13	296
57-1711-23	282	58-1056-28	289	59-1510-13	296
57-1712-05	283	58-1058-30	289	59-1600-13	296
57-1712-06	283	58-1058-36	289	59-1610-01	296
57-1712-07	283	58-1058-38	289	59-1610-02	296
57-1712-08	283	58-1060-44	290	61-1132-20	306
57-1712-09	283	58-1080-32	290	61-1145-18	306
57-1712-11	283	58-1080-38	290	61-1201-24	306
57-1712-12	283	58-1084-36	290	62-1406-00	300
57-1712-14	283	58-1084-40	290	62-1406-01	300
57-1712-15	283	58-1200-21	291	62-1406-02	300
57-1712-16	283	58-1236-01	292	62-1408-00	300
57-1712-19	283	58-1236-02	202	62-1408-01	300
57-1712-20	283	58-1237-01	292	62-1408-12	300
57-1712-21	283	58-1237-02	292	62-1410-16	300
57-1712-23	283	58-1244-01	291	62-1411-15	300
57-1713-05	283	58-1244-02	291	62-1414-13	300
57-1713-06	283	58-1244-03	291	62-1414-14	300
57-1713-07	283	58-1245-01	291	62-1414-17	300
57-1713-08	283	58-1245-02	291	62-1430-11	300
57-1713-09	283	58-1245-03	291	62-1430-12	300
57-1713-11	283	58-1252-30	291	62-1448-00	299
57-1713-12	283	58-1260-27	291	62-1448-01	299
57-1713-14	283	58-1261-27	291	62-1448-02	299
57-1713-15	283	58-1300-42	292	62-1448-03	299
57-1713-16	283	58-1600-34	292	62-1448-04	299
57-1713-19	283	59-1000-14	295	62-1452-01	299
57-1713-20	283	59-1002-14	295	62-1452-02	299
57-1713-21	283	59-1010-10	295	62-1452-11	299
57-1713-23	283	59-1012-14	295	62-1467-01	298
57-1720-30	284	59-1020-10	295	62-1467-02	298
57-1720-35	284	59-1030-14	295	62-1467-03	298
57-1720-40	284	59-1100-03	295	62-1467-11	298
57-1721-30	284	59-1100-04	295	62-1467-12	298
57-1721-35	284	59-1100-05	295	62-1467-13	298
57-1721-40	284	59-1100-06	295	62-1467-14	298
57-1722-30	285	59-1110-03	294	62-1469-01	298
57-1722-35	285	59-1110-04	294	62-1469-02	298

62-1469-03	298	64-1301-12	304	64-1360-25	305
62-1469-04	298	64-1301-14	304	64-1361-10	304
62-1469-11	298	64-1301-16	304	64-1361-15	304
62-1469-12	298	64-1302-08	304	64-1361-20	304
62-1469-13	298	64-1302-10	304	64-1361-25	304
62-1469-14	298	64-1302-12	304	64-1362-10	305
62-1469-15	298	64-1302-14	304	64-1362-15	305
62-1469-16	298	64-1302-16	304	64-1362-20	305
62-1472-01	298	64-1318-04	305	64-1362-25	305
62-1472-02	298	64-1318-06	305	64-1450-06	306
62-1472-03	298	64-1318-08	305	64-1450-15	306
62-1472-04	298	64-1318-10	305	64-1450-20	306
62-1472-11	298	64-1318-12	305	64-1450-25	306
62-1472-12	298	64-1318-14	305	64-1450-30	306
62-1472-13	298	64-1319-04	305	64-1450-38	306
62-1472-14	298	64-1319-06	305	64-1450-44	306
62-1472-15	298	64-1319-08	305	64-1450-50	306
62-1472-16	298	64-1319-10	305	64-1451-06	306
62-1487-01	299	64-1319-12	305	64-1451-15	306
62-1487-02	299	64-1319-14	305	64-1451-20	306
62-1487-11	299	64-1334-03	304	64-1451-25	306
62-1487-12	299	64-1334-04	304	64-1451-30	306
63-1440-19	301	64-1334-05	304	64-1451-38	306
63-1465-01	302	64-1334-06	304	64-1451-44	306
63-1465-02	302	64-1336-03	304	64-1451-50	306
63-1465-03	302	64-1336-04	304	76-1130-04	309
63-1465-04	302	64-1336-05	304	76-1130-06	309
63-1472-19	303	64-1336-06	304	76-1130-08	309
63-1476-15	302	64-1350-06	305	76-1130-10	309
63-1477-10	302	64-1350-09	305	76-1130-12	309
63-1477-15	302	64-1350-13	305	76-1130-15	309
63-1477-20	302	64-1350-16	305	76-1133-00	309
63-1477-25	302	64-1350-19	305	76-1133-10	309
63-1478-15	302	64-1350-25	305	76-1133-20	309
63-1479-15	303	64-1350-32	305	76-1133-30	309
63-1480-04	303	64-1351-06	305	76-1133-40	309
63-1480-06	303	64-1351-09	305	76-1133-50	309
63-1480-08	303	64-1351-13	305	76-1133-60	309
63-1481-17	303	64-1351-16	305	76-1133-70	309
63-1483-17	303	64-1351-19	305	76-1133-80	309
63-1485-17	303	64-1351-25	305	76-1133-90	309
63-1487-17	303	64-1351-32	305	76-1140-17	309
63-1488-21	303	64-1352-09	306	76-1140-25	309
63-1501-17	301	64-1352-14	306	76-1140-27	309
63-1512-16	301	64-1352-16	306	76-1142-06	309
63-1512-17	301	64-1352-19	306	76-1142-07	309
63-1520-08	301	64-1352-25	306	76-1142-08	309
63-1520-10	301	64-1353-09	306	76-1142-09	309
64-1300-08	304	64-1353-14	306	76-1151-14	308
64-1300-10	304	64-1353-16	306	76-1154-12	308
64-1300-12	304	64-1353-19	306	76-1160-20	308
64-1300-14	304	64-1353-25	306	76-1163-27	308
64-1300-16	304	64-1360-10	305	76-1164-23	308
64-1301-08	304	64-1360-15	305	76-1166-35	308
64-1301-10	304	64-1360-20	305	76-1200-01	310

76-1200-02	310
76-1200-03	310
76-1200-04	310
76-1200-05	310
76-1200-06	310
76-1200-07	310
76-1200-08	310
76-1200-09	310
76-1300-00	310
76-1300-01	310
76-1310-25	310
76-1310-50	310
76-1800-01	311
76-1800-02	311
76-1800-10	311

M. Ermis
Möhringer Straße 3
78532 Tuttlingen
Telefon +49 (7461) 160328
Fax +49 (7461) 160598
www.m-ermis.com
E-mail: infos@m-ermis.com